

ASSEMBLY



Combining Efficiency, Reliability and Value...

POWER TOOLS

ASSEMBLY

PUTTING IT ALL TOGETHER

To keep up with the rapidly growing demands of modern assembly applications, Sioux Tools remains on the cutting edge of engineering design. We continue to be innovative in creating new tools to provide faster rundown speeds with exceptional accuracy and consistent torque delivery, combined with ergonomic design for operator comfort and safety.

We build every tool to help assembly operators become more productive. We believe they deserve tools that will help improve their quality of performance and maximize the skills they bring to the job.

EXCLUSIVE DESIGNS

Sioux Tools is the exclusive manufacturer of the Z-handle. This unique feature allows access to tight, hard to reach angles.

IMPACT WRENCHES

Suitable for general assembly, repair jobs, etc. When you require a powerful, lightweight tool, with little reaction force and moderate accuracy. This is the best choice for loosening joints.

SCREWDRIVERS

Sioux Tools offers a wide range of screwdrivers designed to meet today's fast paced, high output assembly and manufacturing applications.

NUTRUNNERS

Sioux offers nutrunners that are designed for high volume industrial production. You can choose from free speeds of up to 2200 rpm, and a torque range of up to 600 in lb (68 Nm). These are outstanding tools for fast, accurate assembly.



An Easy Drive Home

Sioux Tools offers a wide range of screwdrivers and nutrunners designed to meet today's fast paced, high output assembly and manufacturing applications. Sioux Tools is able to provide a perfect match for any job requirement. As industries strive to reduce fastener requirements, we work to meet the demand for greater accuracy and precision in fastening performance. The productivity demands for quality and speed, as well as user comfort, convenience and safety make Sioux Tools your number one choice.

CONFIGURATIONS

Sioux screwdrivers are available in pistol grip, inline, right angle and our exclusive Z-handle configurations. Most screwdriver models offer your choice of Quick Change or Locking Internal Hex spindles. The spring-loaded chuck on the Quick Change allows for fast, easy bit changes without the need for additional tools or hardware. The slimmer

ASSEMBLY SAFETY

Broken sockets, bits and adapters can cause injury.

Proper eye protection must be worn at all times by tool user and bystanders. Use only sockets, bits and adapters made for power tools and that are in good condition. Use only bits and adapters that are in good condition. Keep hands away from sockets, bits and adapters.

Sudden and unexpected tool movement can cause injury.

Be sure your body position allows you to have control of the tool at all times. Make sure your footing is secure. Consult manufacturer for proper reaction bar if movement is excessive.

Tools starting unexpectedly can cause injury.

Always remove the tool from air supply and activate trigger to bleed air line before making any adjustments, changing accessories, or doing any maintenance or service on the tool.

Falling tools can cause injury.

If the tool is used with a balancer or other suspension device, be sure the tool is firmly attached to the device.

ASSEMBLY PRINCIPLES OF OPERATION

An air motor and planetary reduction gearing are used to drive a clutch spindle, producing torque in a fastener.

The action of the torque creates clamp-load in the assembly.

Motor size (horsepower), gear ratio, and type of clutch determine performance, and are key factors in selecting the appropriate tool for a given application.

Generally equipped with a 1/4" female hexagon spindle that allows inserting a screwdriver bit.



design of the Locking Internal Hex ensures that the bit stays firmly in place until you choose to remove it with the aid of a vise or pliers.

REDUCING PHYSICAL LOAD

We design all our screwdrivers with ergonomics in mind. We help you get the job done with a minimum amount of effort and wear and tear on the operator. By reducing the physical load on the operator, which includes noise and oil mist, productivity will be improved. Sioux Tools offers many benefits including high torque accuracy, low sound levels and ergonomic grips. Fast clutch shutoff reduces reaction force, while the shape reduces the amount of gripping and trigger force required.





CLUTCH SELECTION

Positive Clutch – Spindle will not turn with motor until operator exerts forward pressure on spindle engaging the clutch. The clutch ratchets when torque resistance from the fastener overcomes the forward pressure and the jaws begin to cam apart. Torque output of the tool is determined by forward pressure from operator and by the cam angle of the clutch jaws. For wood, sheet metal, and machine screws and lag bolts.

Sioux Tools is the exclusive manufacturer of three different positive clutches; Low, Mid and High torque output. Your choice of clutch allows you to more precisely control the amount of torque exerted on the fastener.





Stall Drive – Spindle is coupled directly with the output of the motor. Final torque is reached when resistance of the fastener overcomes the torque output of the motor. Final torque can be influenced by air pressure and/or operator twisting the tool. For prevailing torque or soft pull applications involving machine, wood, or self-tapping screws.

Adjustable Clutch – Spindle will not turn with motor until operator exerts forward pressure on spindle engaging the clutch. When fastener is tight, clutch will ratchet. Adjusting spring pressure will effect final output torque. Offers consistent torque control with little operator reaction.

Torque Control – Motor shuts off automatically when fastener is tight. Adjusting spring pressure changes final output torque for critical torque requirements. Perfect for applications with little or no prevailing torque where final torque is substantially higher than rundown torque.

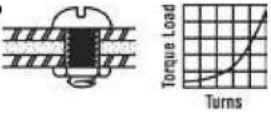
Direct Clutch – Spindle will not turn with motor until operator exerts forward pressure on spindle engaging the clutch. Final torque is reached when resistance of the fastener overcomes the torque output of the motor. Excellent stall type tool when tightening group of fasteners without turning off motor.

CLUTCH SELECTION GUIDE

Type of Job	Clutch Performance			
	Torque Control	Adjustable	Direct/Stall Drive	Positive Clutch
<p>1. Free-Running – Sudden Stop</p>  <p>Turns easily until screw head or nut seats against a solid stop. Resistance then builds up suddenly.</p>	Excellent for all size screws.	Good for all size screws. Close torque control is not required.	Good for large or medium nuts or cap screws only.	Fair for all size screws where close torque accuracy is not required.
<p>2. Soft Pull-Up</p>  <p>Turns easily until screw head or nut seats, then resistance builds up gradually through one or more turns as resilient material compressed.</p>	Excellent for all size screws.	Good for most screws. Close torque control is not required. Slow on large screws with long pull-up.	Good for large and medium size screws. Must be adjusted to run rather slowly for small screws.	Good for small to medium size screws. Requires considerable operator pressure on large screws.
<p>3. Self-Tapping in Thick Material</p>  <p>Increasing heavy resistance through entire travel until screw head seats. Then either (A) gradual, or (B) sudden final build-up resistance.</p>	Excellent for all size screws. Not suitable if tapping torque exceeds stripping torque.	Good for most screws. With proper operator technique, can be used where tapping torque exceeds stripping torque. Slow on large screws.	Not recommended unless stripping torque is considerably higher than tapping torque.	Good for most size screws where stripping torque is considerably higher than tapping torque. Excellent in non-uniform or misaligned material.
<p>4. Sheet Metal Screws</p>  <p>Resistance increases rapidly at first, then eases slightly. At the end, it usually builds up suddenly when screw head seats.</p>	Good for all size screws. Not suitable if tapping torque exceeds stripping torque.	Good for most screws. With proper operator technique, can be used where tapping torque exceeds stripping torque.	Not recommended unless stripping torque is considerably higher than tapping torque.	Good for all size screws where stripping torque is considerably higher than tapping torque. Excellent when sheets are frequently misaligned.
<p>5. Lock Nuts</p>  <p>Starts with heavy resistance that lasts through entire travel until screw or nut seats. Then either (A) gradual, or (B) sudden further build-up resistance.</p>	Excellent for all size screws.	Good for most screws. Close torque control is not required.	Good for large and medium screws. Must be adjusted to run rather slowly for small screws.	Fair for all size screws.
<p>6. Wood Screws</p>  <p>Starts with small resistance that steadily increases through entire travel with additional resistance as screw head seats.</p>	Fair for all size screws.	Good for all size screws.	Excellent for large and medium screws. Must be adjusted to run rather slowly for small screws.	Excellent for all size screws.

Tool Selection Guide



CONSIDERATIONS FOR SELECTING SCREWDRIVERS

This should be done in a systematic way to ensure no details are overlooked that could have an adverse effect on job function or results. The following are variables that must be considered to ensure proper tool selection.

- | | |
|---|--|
| What is being assembled? | What is the production rate? |
| What material is involved? | Are there clearance problems? |
| What type of screw or nut is being driven? What head type? | What handle style is required (straight or pistol)? |
| What screw size (standard or metric)? | Is the tool to be hand held or fixtured? |
| What U.S. grade or metric class? | What type of clutch? |
| What torque (inch pounds or Newton meters)? | Speed required? |
| What torque tolerance (accuracy)? | Is there a need for a reversible tool? |
| What is the run-down torque vs. seating torque? | What type of drive (square, 1/4" hex, quick change)? |
| What type of joint pull-up (hard, medium, soft)? | How is the application being done now? |
| What pull-up conditions (free run-down, sheet metal, wood, or plastic)? | Special consideration? |

WHAT IS THE SIZE AND TYPE OF SCREW OR FASTENER ON WHICH THE TOOL WILL BE USED?

- No 1 Series Tools** – 2 to 50 in lb of torque. (Fasteners up to 1/4")
- .6 & 1 HP Signature Series Tools** – 5 to 400 in lbs of torque. (Fasteners up to 3/8")
- No 3 Series Tools** – 5 to 50 ft lbs of torque. (Fasteners up to 1/2")

WHAT KIND OF APPLICATION AND MATERIAL WILL THE FASTENER BE USED ON?

The type of material helps to determine which type of clutch is needed.

APPLICATION & MATERIAL GUIDE

Screw Size	Clutch	Free Run Down	Soft Pull-Up	Prevailing Torque
No 8 and Smaller	Adjustable	Excellent	Excellent	Excellent
	Stall	Excellent	Good	Excellent
	Direct	Good	Good	Good
	Positive	Fair	Fair	Good
No 10 and Larger	Adjustable	Good	Fair	Fair
	Stall	Good	Excellent	Excellent
	Direct	Good	Excellent	Excellent
	Positive "P"	Good	Excellent	Excellent
	Positive "PS"	Good	Excellent	Excellent

WHAT ARE THE TORQUE REQUIREMENTS?

Most air tools share the quality: as the speed increases, the torque decreases. This applies to tools within the same horsepower rating.

- A. Stall or direct clutch gives the most torque.
- B. Positive clutch tools are operator influenced.
- C. Adjustable torque clutches are available on most Sioux fastening tools.
- D. Torque control is available on No 1 series

AT WHAT ANGLE OR POSITION WILL THE TOOL BE USED?

This will determine the style of tool best suited from an ergonomics point of view.

- A. If the fastener is in a vertical position, a straight or lever style tool will be best.
- B. If the fastener is in a horizontal position a pistol style tool will be best.
- C. If the fastener is in a tight or constricted area the "2S" series works well in this application.

IS REVERSING NECESSARY?

Most fastening applications are going to require a reversible tool. Keep in mind that in most cases a non-reversing tool will have more torque than a reversible tool.

IS THE APPLICATION OPERATOR INFLUENCED OR RESTRICTED?

- A. Is the operator male or female? This can be a factor in determining the size of the power tool (weight for example).
- B. Does the application lend itself to an auto start tool, as in the No 1 series?

AN EXAMPLE OF APPLYING THESE QUESTIONS TO AN APPLICATION WOULD BE:

Driving a 2" long wood screw into hardwood with a pilot hole. The fastener is in a horizontal position during assembly. A test with a hand torque wrench indicates a prevailing torque of 80 in lbs, and a failing torque of 120 in lbs.

- | | |
|----------------------------------|--------------------------|
| 1. 2" long wood screw | 4. Pistol will work best |
| 2. Hard Wood use positive clutch | 5. Need reversing |
| 3. SSD10P20PS – 100 in lbs | 6. Mostly male workers |



Screwdriver Maintenance



Adjustable Clutch Screwdrivers

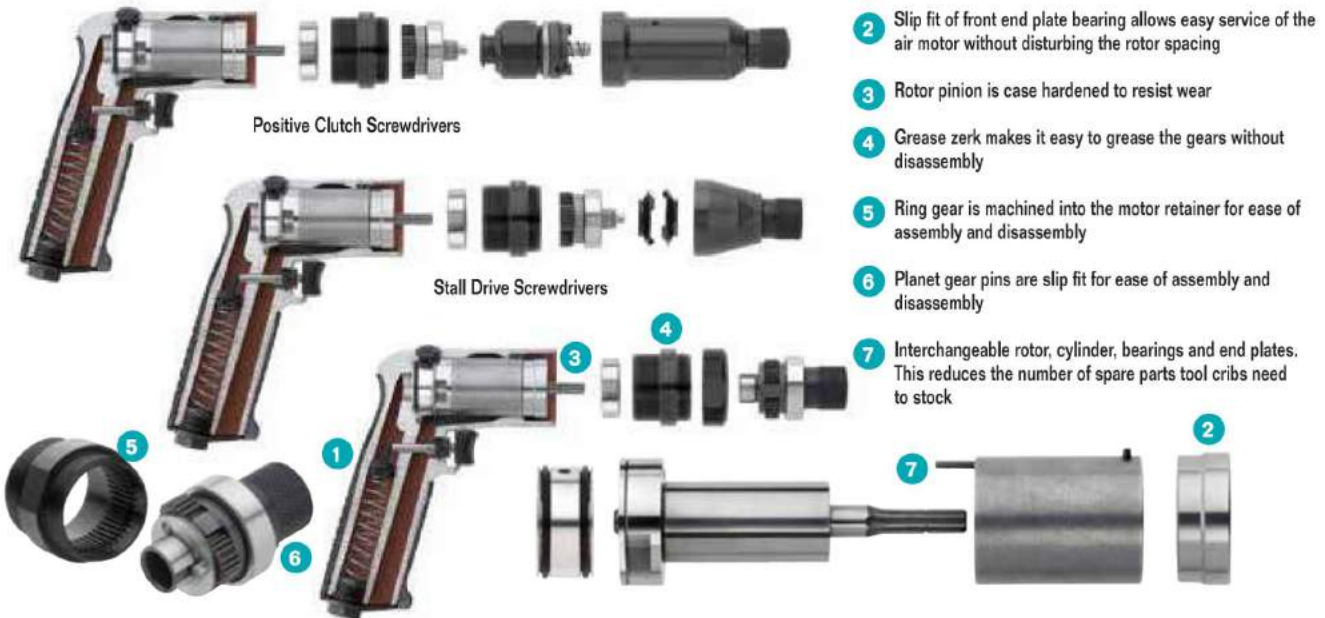

- 1 Tipper valve and valve seat is easily accessible for service
- 2 Slip fit of front end plate bearing allows easy service of the air motor without disturbing the rotor spacing
- 3 Rotor pinion is case hardened to resist wear
- 4 Grease zerk makes it easy to grease the gears without disassembly
- 5 Ring gear is machined into the motor retainer for ease of assembly and disassembly
- 6 Planet gear pins are slip fit for ease of assembly and disassembly
- 7 Interchangeable rotor, cylinder, bearings and end plates. This reduces the number of spare parts tool cribs need to stock

POWER TOOLS

ASSEMBLY

GUIDE TO FASTENERS

Screw Type

Standard Nosepieces Available For All Fasteners Shown Below

Wood Screws



Machine Screws

* Standard or Special, depending on the washer diameter.



Tapping or Sheet Metal Screws



Drive Systems

* Special bits required for Clutch and Torx internal and external. Call factory.

Standard



Special*





POWER TOOLS

ASSEMBLY: SCREWDRIVERS

PERFORMANCE:

Torque: 24 in lb (2.7 Nm) – 216 in lb (24.4 Nm)
Speed: 725 rpm – 2500 rpm

FEATURES:

Reversible and Non-reversible
Trigger Start
Trigger or Shuttle Reverse
Comfort Grip
Rotatable Exhaust (1OM series)

POSITIVE CLUTCH PISTOL GRIP & T-HANDLE SCREWDRIVERS



Model Number	Max Torque ¹ (Soft Joint)		Free Speed rpm	Weight		Length		Side To Center		Air Consumption		Sound Level dB(A)
	in lb	Nm		lb	kg	in	mm	in	mm	cfm	l/s	
1 Series – Rapid Reverse – 1/4" Quick Change												
1OM2103	55	6.2	725	1.8	0.80	7.7	196	0.7	17	8	4	75
1OM2203	40	4.5	1000	1.8	0.80	7.7	196	0.7	17	8	4	75
1OM2303	30	3.4	1400	1.8	0.80	7.7	196	0.7	17	8	4	75
1OM2403	24	2.7	2000	1.6	0.70	6.7	170	0.7	17	8	4	75
0.6 hp (0.45 kW) Medium Clutch Screwdrivers – 1/4" Quick Change												
SSD6P12P	100	11.3	1200	2.6	1.18	8.6	218	0.8	20	25	12	80
SSD6P20P	55	6.2	2000	2.2	0.98	6.8	171	0.8	20	25	12	80
SSD6P20PSRR	55	6.2	2000	2.2	0.98	6.8	171	0.8	20	25	12	80
SSD6P25P	40	4.5	2500	2.2	0.98	6.8	171	0.8	20	25	12	80
SSD6P25PSRR	40	4.5	2500	2.2	0.98	6.8	171	0.8	20	25	12	80
1 hp (0.75 kW) Medium Torque Clutch Screwdrivers – 1/4" Quick Change												
SSD10P12P	135	15.3	1200	2.8	1.30	9.1	231	0.8	20	30	14	80
SSD10P20P	70	7.9	2000	2.4	1.07	7.3	185	0.8	20	30	14	80
SSD10P25P	50	5.7	2500	2.4	1.07	7.3	185	0.8	20	30	14	80
1 hp (0.75 kW) High Torque Clutch Screwdrivers – 1/4" Quick Change												
SSD10P12PS	145	16.4	1200	2.8	1.30	9.1	231	0.8	20	30	14	80
SSD10P20PS	80	9	2000	2.4	1.07	7.3	185	0.8	20	30	14	80
SSD10P25PS	58	6.5	2500	2.4	1.07	7.3	185	0.8	20	30	14	80
1 hp (0.75 kW) – Medium Torque Positive Clutch Rapid Reverse Screwdriver												
SSD10P20PRR	70	7.9	2000	2.4	1.07	7.3	185	0.8	20	30	14	80
SSD10P25PRR	50	5.7	2500	2.4	1.07	7.3	185	0.8	20	30	14	80
3 Series T-Handle – 7/16" Quick Change												
3T2303 ¹	216	24.4	850	6.7	3	33	840	1	25	33	16	81

¹ Torque output varies with force exerted by operator

General: Air Inlet Size: 1/4" NPT • Recommended Hose Size: 1/4" (6 mm) (1OM series) • Performance rated @ 90 psig (6.2 bar) air pressure

Standard Equipment: Parts List • Safety and Instruction Manual • Comfort Grip (1OM series)

Accessories: Screwdriver Accessories, Screwdriver Bits and Finders see page 685



Safety Precaution: Read and follow all safety and operation instructions.
Warning: Face & eye protection must be worn while operating power tools, per ANSI B136.1.



PERFORMANCE:

Torque: 55 in lb (6.2 Nm)
Speed: 800 rpm

FEATURES:

Reversible
Lever Start
Rear Exhaust



1SM2103



POSITIVE CLUTCH INLINE SCREWDRIVERS

Model Number	Max Torque ¹ (Soft Joint)		Free Speed rpm	Weight		Length		Side To Center		Air Consumption		Sound Level dB(A)
	in lb	Nm		lb	kg	in	mm	in	mm	cfm	l/s	
Inline												
1SM2103	55	6.2	800	1.4	0.6	9.1	231	0.6	15	8	4	75

¹ Torque output varies with force exerted by operator

General: Air Inlet Size: 1/4" NPT • Recommended Hose Size: 1/4" (6 mm) (1SM series) • Performance rated @ 90 psig (6.2 bar) air pressure

Standard Equipment: Parts List • Safety and Instruction Manual • Comfort Grip (1SM series)

Accessories: Screwdriver Accessories, Screwdriver Bits and Finders see page 685

PERFORMANCE:

Torque: 18 in lb (2 Nm) – 400 in lb (45.2 Nm)
Speed: 300 rpm – 2600 rpm

FEATURES:

Reversible
Trigger Start
Rapid or Shuttle Reverse
Comfort Grip
1/4" Quick Change



1OM2407

SSD6P20S

SSD10P20S

SSD10P20SRR



STALL PISTOL GRIP SCREWDRIVERS

Model Number	Max Torque (Soft Joint)		Free Speed rpm	Weight		Length		Side To Center		Air Consumption		Sound Level dB(A)
	in lb	Nm		lb	kg	in	mm	in	mm	cfm	l/s	
Trigger Start - Trigger Reverse												
1OM2107	55	6.2	725	1.8	0.80	7.7	196	0.7	18	8	4	75
1OM2207	40	4.5	1000	1.8	0.80	7.7	196	0.7	18	8	4	75
1OM2307	30	3.4	1400	1.8	0.80	7.7	196	0.7	18	8	4	75
1OM2407	24	2.7	2000	1.6	0.70	6.7	170	0.7	18	8	4	75
1OM2507	18	2	2600	1.6	0.70	6.7	170	0.7	18	8	4	75
0.6 hp (0.45 kW) Trigger Start - Shuttle Reverse												
SSD6P7S	155	17.8	700	2.4	1.10	6.8	171	0.8	20	25	12	80
SSD6P12S	100	11.3	1200	2.4	1.10	6.8	171	0.8	20	25	12	80
SSD6P20S	55	6.2	2000	2	0.90	5.8	146	0.8	20	25	12	80
SSD6P25S	40	4.5	2500	2	0.90	5.8	146	0.8	20	25	12	80
0.6 hp (0.45 kW) Trigger Start - Rapid Reverse												
SSD6P20SRR	55	6.2	2000	2	0.90	5.8	146	0.8	20	25	12	80
1 hp (0.75 kW) Trigger Start - Shuttle Reverse												
SSD10P3S	400	45.2	300	2.6	1.17	7.5	191	0.8	20	30	14	80
SSD10P5S	325	36.7	500	2.6	1.17	7.5	191	0.8	20	30	14	80
SSD10P7S	220	24.9	700	2.6	1.17	7.5	191	0.8	20	30	14	80
SSD10P12S	145	16.4	1200	2.6	1.17	7.5	191	0.8	20	30	14	80
SSD10P20S	80	9	2000	2.2	0.98	6.5	165	0.8	20	30	14	80
SSD10P25S	58	6.6	2500	2.2	0.98	6.5	165	0.8	20	30	14	80
1 hp (0.75 kW) - Stall Rapid Reverse												
SSD10P20SRR	80	9	2000	2.2	0.98	6.5	165	0.8	20	30	14	80

General: Air Inlet Size: 1/4" NPT • Recommended Hose Size: 1/4" (6 mm) (1OM series); 3/8" (10 mm) • Performance rated @ 90 psig (6.2 bar) air pressure

Standard Equipment: Parts List • Safety and Instruction Manual • Comfort Grip

Accessories: Screwdriver Accessories, Screwdriver Bits and Finders see pages 685



PERFORMANCE:

Torque: 24 in lb (2.7 Nm) – 400 in lb (45.2 Nm)
Speed: 300 rpm – 2500 rpm

FEATURES:

Reversible
Lever Start
Rear Exhaust
Suspension Bail
1/4" Quick Change



STALL INLINE SCREWDRIVERS

Model Number	Max Torque (Soft Joint)		Free Speed rpm	Weight		Length		Side To Center		Air Consumption		Sound Level dB(A)
	in lb	Nm		lb	kg	in	mm	in	mm	cfm	l/s	
Inline - Reversible - 1/4" Quick Change Drive												
1SM2107	55	6.2	800	1.4	0.60	9.1	231	0.6	15	8	4	75
1SM2407	24	2.7	2200	1.3	0.60	8.1	206	0.6	15	8	4	75
Inline - Stall Clutch												
SSD10S3S	400	45.2	300	2.2	1.00	9.5	240	0.8	20	30	14	80
SSD10S5S	325	36.7	500	2.2	1.00	9.5	240	0.8	20	30	14	80
SSD10S7S	220	24.9	700	2.2	1.00	9.5	240	0.8	20	30	14	80
SSD10S12S	145	16.4	1200	2.2	1.00	9.5	240	0.8	20	30	14	80
SSD10S20S	80	9	2000	1.9	0.85	8.4	215	0.8	20	30	14	80
SSD10S25S	58	6.6	2500	1.9	0.85	8.4	215	0.8	20	30	14	80

General: Air Inlet Size: 1/4" NPT • Recommended Hose Size: 1/4" (6 mm) (1SM series); 3/8" (10 mm) (SSD series) • Performance rated @ 90 psig (6.2 bar) air pressure

Standard Equipment: Parts List • Safety and Instruction Manual • Comfort Grip (1SM series) • Suspension Bail

Accessories: Screwdriver Accessories, Screwdriver Bits and Finders see page 685

PERFORMANCE:

Torque: 20 in lb (2.3 Nm) – 140 in lb (15.8 Nm)
Speed: 300 rpm – 2500 rpm

FEATURES:

Reversible
Trigger Start
Rapid or Shuttle Reverse
Comfort Grip



ADJUSTABLE CLUTCH PISTOL GRIP SCREWDRIVERS

Model Number	Max Torque (Soft Joint)		Free Speed rpm	Weight		Length		Side To Center		Air Consumption		Sound Level dB(A)
	in lb	Nm		lb	kg	in	mm	in	mm	cfm	l/s	
Trigger Start - Rapid Reverse												
1OM2105Q	50	5.7	725	2.1	0.95	8.8	224	0.7	17	8	4	75
1OM2205Q	35	4	1000	2.1	0.95	8.8	224	0.7	17	8	4	75
1OM2305Q	25	2.8	1400	2.1	0.95	8.8	224	0.7	17	8	4	75
1OM2405Q	20	2.3	2000	1.9	0.86	7.8	198	0.7	17	8	4	75
0.6 hp (0.45 kW) Trigger Start - Shuttle Reverse												
SSD6P7AC	140	15.8	700	3	1.36	10.3	262	0.8	20	25	12	80
SSD6P12AC	100	11.3	1200	3	1.36	10.3	262	0.8	20	25	12	80
SSD6P20AC	55	6.2	2000	2.6	1.16	8.5	216	0.8	20	25	12	80
SSD6P25AC	40	4.5	2500	2.6	1.16	8.5	216	0.8	20	25	12	80
1 hp (0.75 kW) Trigger Start - Shuttle Reverse												
SSD10P3AC	140	15.8	300	3.2	1.45	10.2	259	0.8	20	30	14	80
SSD10P5AC	140	15.8	500	3.2	1.45	10.2	259	0.8	20	30	14	80
SSD10P7AC	140	15.8	700	3.2	1.45	10.2	259	0.8	20	30	14	80
SSD10P12AC	120	13.5	1200	3.2	1.45	10.2	259	0.8	20	30	14	80
SSD10P20AC	80	9	2000	2.8	1.25	8.4	213	0.8	20	30	14	80
SSD10P25AC	60	6.8	2500	2.8	1.25	8.4	213	0.8	20	30	14	80

General: Air Inlet Size: 1/4" NPT • Recommended Hose Size: 1/4" (6 mm) (1OM series); 3/8" (10 mm) • Performance rated @ 90 psig (6.2 bar) air pressure

Standard Equipment: Parts List • Safety and Instruction Manual • Comfort Grip • Clutch Adjustment Wrench

Accessories: Screwdriver Accessories, Screwdriver Bits and Finders see page 685





PERFORMANCE:

Torque: 20 in lb (2.3 Nm) – 140 in lb (15.8 Nm)
Speed: 300 rpm – 2500 rpm

FEATURES:

Reversible
Rear Exhaust
External Clutch Adjustment



ADJUSTABLE CLUTCH INLINE SCREWDRIVERS



Model Number		Max Torque (Soft Joint)		Free Speed	Weight		Length		Side To Center		Air Consumption		Sound Level
1/4" Quick Change	1/4" Internal Hex	in lb	Nm	rpm	lb	kg	in	mm	in	mm	cfm	l/s	dB(A)
Inline – Lever Start													
1SM2105Q		50	5.7	800	1.6	0.70	10.3	262	0.6	15	8	4	75
1SM2205Q		35	4	1100	1.6	0.70	10.3	262	0.6	15	8	4	75
1SM2305Q		25	2.8	1500	1.6	0.70	10.3	262	0.6	15	8	4	75
1SM2405Q	1SM2405	20	2.3	2200	1.4	0.60	9.3	236	0.6	15	8	4	75
Inline – Lever Start													
SSD10S3AC		140	15.8	300	2.8	1.25	12.3	315	0.8	20	30	14	80
SSD10S5AC		140	15.8	500	2.8	1.25	12.3	315	0.8	20	30	14	80
SSD10S7AC		140	15.8	700	2.8	1.25	12.3	315	0.8	20	30	14	80
SSD10S12AC		120	13.5	1200	2.8	1.25	12.3	315	0.8	20	30	14	80
SSD10S20AC		80	9	2000	2.5	1.15	11.2	285	0.8	20	30	14	80
SSD10S25AC		60	6.8	2500	2.5	1.15	11.2	285	0.8	20	30	14	80

General: Air Inlet Size: 1/4" NPT • Recommended Hose Size: 1/4" (6 mm) (1SM series); 3/8" (10 mm)(SSD series) • Performance rated @ 90 psig (6.2 bar) air pressure

Standard Equipment: Parts List • Safety and Instruction Manual • Comfort Grip (1SM series) • Suspension Bail • Clutch Adjustment Wrench

Accessories: Screwdriver Accessories, Screwdriver Bits and Finders see page 685

PERFORMANCE:

Torque: 5 in lb (0.6 Nm) – 50 in lb (5.5 Nm)
Speed: 300 rpm – 2800 rpm

FEATURES:

Push-to-Start
Reversible
Locking Button Reverse
External Clutch Adjustment



1OT2208Q



TORQUE CONTROL SCREWDRIVERS

Model Number		Max Torque (Soft Joint)		Free Speed	Weight		Length		Side To Center		Air Consumption		Sound Level
1/4" Quick Change		in lb	Nm	rpm	lb	kg	in	mm	in	mm	cfm	l/s	dB(A)
Inline – Push To Start													
1ST2108Q		5-50	0.6-5.5	800	1.6	0.7	9.3	236	0.6	15	8	4	75
1ST2208Q		5-35	0.6-4	1100	1.6	0.7	9.3	236	0.6	15	8	4	75
1ST2308Q		5-25	0.6-3	1500	1.6	0.7	9.3	236	0.6	15	8	4	75
1ST2508Q		5-14	0.6-1.5	2800	1.4	0.6	8.3	211	0.6	15	8	4	75
Pistol Grip – Push To Start													
1OT2108Q		5-50	0.6-5.5	725	2.1	1.0	8.8	225	0.7	17	10	5	75
1OT2208Q		5-35	0.6-4	1000	2.1	1.0	8.8	225	0.7	17	10	5	75
1OT2308Q		5-25	0.6-3	1400	2.1	1.0	8.8	225	0.7	17	10	5	75
1OT2508Q		5-14	0.6-1.5	2600	1.9	0.9	7.8	200	0.7	17	10	5	75

General: Air Inlet Size: 1/4" NPT • Recommended Hose Size: 1/4" (6 mm) (1OT, 1ST series) • Performance rated @ 90 psig (6.2 bar) air pressure

Standard Equipment: Parts List • Safety and Instruction Manual • Comfort Grip (1OT, 1ST series) • Suspension Bail (Inline models)

Accessories: Screwdriver Accessories, Screwdriver Bits and Finders see page 685



PERFORMANCE:

Torque: 36 in lb (4.1 Nm) –
70 in lb (7.9 Nm)
Speed: 1000 rpm – 2200 rpm

FEATURES:

Lever Start
Rear Exhaust

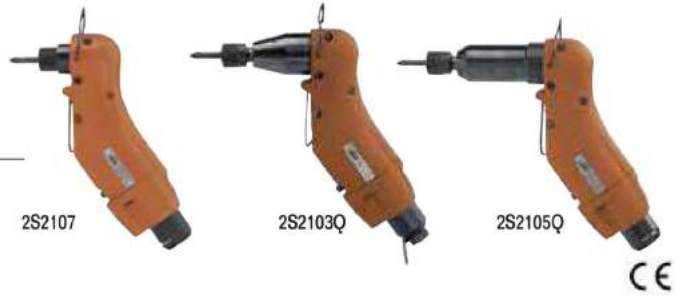

Z-HANDLE SCREWDRIVERS

Model Number	Max Torque ¹ (Soft Joint)		Free Speed	Weight		Length		Side To Center		Air Consumption		Sound Level	
	1/4" Quick Change	in lb		Nm	rpm	lb	kg	in	mm	in	mm		cfm
Z-Handle – Stall													
2S2107		70	7.9	1000	2.3	1	2.9	74	0.9	23	16	8	75
2S2207		50	5.7	1600	2.3	1	2.9	74	0.9	23	16	8	75
2S2307		36	4.1	2200	2.3	1	2.9	74	0.9	23	16	8	75
Z-Handle – Low Torque Clutch¹													
2S2103Q		60	6.8	1000	2.6	1.2	4.3	109	0.9	23	16	8	75
Z-Handle – Mid-Torque Clutch¹													
2S2103AQ		60	6.8	1000	2.6	1.2	4.3	109	0.9	23	16	8	75
2S2203AQ		46	5.2	1600	2.6	1.2	4.3	109	0.9	23	16	8	75
2S2303AQ		30	3.4	2200	2.6	1.2	4.3	109	0.9	23	16	8	75
Z-Handle – Lever Start – Adjustable Clutch													
2S2105Q		60	6.8	1000	2.9	1.3	5.8	147	0.9	23	16	8	75
2S2305Q		30	3.4	2200	2.9	1.3	5.8	147	0.9	23	16	8	75

¹ Torque output varies with force exerted by operator

General: Air Inlet Size: 1/4" NPT • Recommended Hose Size: 3/8" (10 mm) • Performance rated @ 90 psig (6.2 bar) air pressure

Standard Equipment: Parts List • Safety and Instruction Manual • Suspension Bail

Accessories: Screwdriver Accessories, Screwdriver Bits and Finders see page 685



PERFORMANCE:

Torque: 35 in lb (4 Nm) –
400 in lb (45.2 Nm)
Speed: 300 rpm – 2000 rpm

FEATURES:

Stall Drive & Adjustable Clutch
Button Reverse
Lever Start
Rear Exhaust

RIGHT ANGLE SCREWDRIVERS

Model Number	Max Torque (Soft Joint)	Free Speed	Weight		Length		Side To Center		Air Consumption		Sound Level	
			in lb	Nm	lb	kg	in	mm	in	mm		cfm
1/4" Quick Change												
1/4" Internal Hex												
Stall Drive												
1AM2101	50	5.7	800	1.5	0.70	10	254	0.3	8	8	4	75
1AM2201	35	4	1100	1.5	0.70	10	254	0.3	8	8	4	75
Stall Drive												
SSD10A3S	400	45.2	300	3.4	1.50	12	305	0.8	20	30	14	80
SSD10A5S	325	36.7	500	3.4	1.50	12	305	0.8	20	30	14	80
SSD10A6S	220	24.9	600	3.4	1.50	12	305	0.8	20	30	14	80
SSD10A10S	145	16.4	1000	3.4	1.50	12	305	0.8	20	30	14	80
SSD10A16S	80	9	1600	3	1.35	11	280	0.8	20	30	14	80
SSD10A20S	58	6.6	2000	3	1.35	11	280	0.8	20	30	14	80
Adjustable Clutch												
1AM2105	50	5.7	800	1.9	0.90	11.8	300	0.3	8	8	4	75
1AM2205	35	4	1100	1.9	0.90	11.8	300	0.3	8	8	4	75

General: Air Inlet Size: 1/4" NPT • Recommended Hose Size: 1/4" (6 mm) (1AM series); 3/8" (10 mm) (SSD series) • Performance rated @ 90 psig (6.2 bar) air pressure

Standard Equipment: Comfort Grip (1AM series)

Accessories: Screwdriver Accessories, Screwdriver Bits and Finders see page 685



Safety Precaution: Read and follow all safety and operation instructions.
Warning: Face & eye protection must be worn while operating power tools, per ANSI B136.1.



3A2104



SNR10A10S



1AM2106

PERFORMANCE:

Torque: 20 in lb (2.3 Nm) –
600 in lb (68 Nm)
Speed: 300 rpm – 2000 rpm

FEATURES:

Reversible
Lever Start
Rear and Side Exhaust



RIGHT ANGLE NUTRUNNERS

Model Number	Bolt Capacity ²		Max Torque (Soft Joint)		Free Speed rpm	Weight		Length		Side To Center		Sound Level dB(A)	Drive Size	
	in	mm	in lb	Nm		lb	kg	in	mm	in	mm		in	mm
Torque Control Clutch														
3A2108 ¹	3/8	M10	360	41	300	7.4	3.40	18.3	465	0.8	20	81	1/2	13
3A2208 ¹	3/8	M10	294	33	480	7.4	3.40	18.3	465	0.8	20	81	1/2	13
Adjustable Clutch														
1AM2106	#10	M4.5	50	5.7	800	1.9	0.90	11.6	295	0.3	8	75	1/4	6
Stall Drive														
1AM2102	#10	M4.5	50	5.7	800	1.5	0.70	11.5	292	0.3	8	75	1/4	6
Stall Drive														
3A2104 ¹	7/16	M11	600	68	300	5.5	2.50	15.5	394	0.8	20	81	1/2	13
Stall Drive														
SNR10A3S	3/8	M10	400	45.2	300	2.9	1.30	12	305	0.8	20	80	3/8	10
SNR10A5S	3/8	M10	325	36.7	500	2.9	1.30	12	305	0.8	20	80	3/8	10
SNR10A6S	3/8	M10	220	24.9	600	2.9	1.30	12	305	0.8	20	80	3/8	10
SNR10A10S	5/16	M8	145	16.4	1000	2.9	1.30	12	305	0.8	20	80	3/8	10
SNR10A16S	1/4	M6	80	9	1600	2.6	1.15	11	280	0.8	20	80	3/8	10
SNR10A20S	#10	M4.5	58	6.6	2000	2.6	1.15	11	280	0.8	20	80	1/4	6

¹ Not CE Certified

² Bolt capacities are based on suggested assembly torques applied to SAE Grade 5 and metric Class 9.8 fasteners under slightly lubricated conditions.

General: Air Inlet Size: 1/4" NPT • Recommended Hose Size: 1/4" (6 mm) (1AM series); 3/8" (10 mm) (SNR, 3A series) • Performance rated @ 90 psig (6.2 bar) air pressure

Standard Equipment: Parts List • Safety and Instruction Manual • Comfort Grip (1AM series) • Clutch Adjustment Wrench

Accessories: Nutrunner Accessories, see page 685



PERFORMANCE:

Power: 0.3 hp (0.25 kW)
Torque: 35 ft lb (47 Nm)

FEATURES:

Lever Start
Teasing Throttle
Comfort Grip



SRW03S-25

RATCHET WRENCHES

Model Number	Drive Size		Torque		Free Speed	Weight		Length		Side to Center		Sound Level	Air Consumption		Exhaust
	in	mm	ft lb	Nm	rpm	lb	kg	in	mm	in	mm	dB(A)	cfm	l/s	
0.3 hp (0.25 kW)															
SRW03S-25	1/4"	6	35	47	235	1.4	0.6	7.7	197	1.1	28	85.9	1.4	0.66	Rear
SRW03S-38	3/8"	10	35	47	235	1.4	0.6	7.7	197	1.1	28	85.9	1.4	0.66	Rear
SRW03S-38Q	3/8"	10	35	47	235	1.4	0.6	7.7	197	1.1	28	85.9	1.4	0.66	Rear

General: Air Inlet Size: 1/4" NPT • Recommended Hose Size: 3/8" (10 mm) • Performance rated @ 90 psig (6.2 bar) air pressure

Standard Equipment: Parts List • Safety and Instruction Manual

Accessories: Ratchet Accessories, see page 685

POWER TOOLS

ASSEMBLY: RATCHET WRENCHES

PERFORMANCE:

Power: 0.7 hp (0.52 kW)
Torque: 65 ft lb (88 Nm)



SRW07-38

RATCHET WRENCHES

Model Number	Drive Size		Torque		Free Speed	Weight		Length		Side to Center		Sound Level	Air Consumption		Exhaust
	in	mm	ft lb	Nm	rpm	lb	kg	in	mm	in	mm	dB(A)	cfm	l/s	
0.7 hp (0.52 kW)															
SRW07-38	3/8"	10	65	88	260	3	1.3	11.8	300	1	25	90	2.7	1.27	Front
SRW07-50	1/2"	13	65	88	260	3	1.3	11.8	300	1	25	90	2.7	1.27	Front

General: Air Inlet Size: 1/4" NPT • Recommended Hose Size: 3/8" (10 mm) • Performance rated @ 90 psig (6.2 bar) air pressure

Standard Equipment: Parts List • Safety and Instruction Manual

Accessories: Ratchet Accessories, see page 685





ASSEMBLY

We're Making A Big Impact

Impact wrenches are the true workhorses of industrial power tools. These incredibly powerful tools make easy work of any job in a variety of applications. Before the creation of impact tools, workers had to manually strike a hammer against a hand wrench in order to loosen or tighten nuts or bolts. They could only manage a few blows per minute. But today's impact wrenches can exert more powerful blows, and some can produce over 2000 blows per minute. This is accomplished by using the energy of compressed air and converting the motor's torque into a rapid series of powerful rotary impacts.

CHOICE OF CONFIGURATION

Sioux Tools offers Industrial and Force Impact Wrenches and Impact Drivers in a wide variety of configurations to meet your specific applications. In order to select the correct impact tool for your job requirements, you must take into account several factors including fastener size and grade, required torque output, and accessibility. Choosing the right mix of features such as handle configuration, type of retainer, torque output, anvil length, and drive size will make operators more productive, with less risk of discomfort and/or injury.

INDUSTRIAL IMPACT TOOLS

Built to a higher level of quality, Sioux Industrial Impact Wrenches and Impact Drivers are built a step above the standard. Manufactured from the highest quality materials, and utilizing the most advanced motor and clutch designs, these tools are constructed to hold up under continuous use in the toughest working environments.

Our extensive lineup of impact tools includes a wide selection of important features including:

- Ball & Cam or Twin Hammer impact mechanisms
- Inline, pistol grip, or D-handle configurations
- Pin, friction ring, quick change, or thru hole socket retainers
- Standard or extended anvils

In addition, Sioux offers a wide range of performance levels and characteristics to ensure a perfect match to your application. With drive sizes ranging from 1/4" (6 mm) to 1-1/2" (38 mm), and torque outputs up to 2500 ft lb (3390 Nm), finding the tool to meet your performance requirements will be simple.

IMPACT WRENCH PRINCIPLES OF OPERATION

An impact wrench delivers a series of rotary blows to a fastener, producing torque.

The action of the torque creates clamp force in an assembly.

Interaction of the motor, clutch and drive-end determine the type of application an impact wrench can handles.

The advantages of impact wrenches are a high power-to weight ratio, fast rundown, and no torque reaction to operator.

CLASS OF SERVICE

High production – automobile assembly plants, farm and construction equipment, etc.

Low production – large machinery assembly

Maintenance or repair work

JOB CONDITIONS

Hard pull-up – rigid joint

Soft pull-up – spring joint

Run-down – free running, or prevailing torque (lock nut, self threading screw)

MATERIAL

Metal-to-metal

Metal/gasket

Rubber or plastic

ASSEMBLY METHOD

General tightening – operator judgment

Turn-of-the-nut – permanent assemblies (steel erection and construction equipment)

Note: If it takes five seconds or longer to reach final tightness, a larger wrench should be used.



IW38TBP-3P



IW38HAP-3P



IW50HAP-4P



IW500MP-4R

POWER TOOLS

ASSEMBLY: IMPACT WRENCHES

PERFORMANCE:

Working Torque: 10 ft lb (13 Nm) – 450 ft lb (610 Nm)
 Drive Size: 3/8" (10 mm) – 1/2" (13 mm) square drive
 Bolt Capacity: 1/4" (6 mm) – 5/8" (16 mm)

FEATURES:

Pistol Grip
 Steel Anvil Housing
 Suspension Bail

3/8" [10 MM] & 1/2" [13 MM] IMPACT WRENCHES



Model Number	Drive Size		Bolt Cap Grade 5		Working Torque Range ¹		Maximum Torque		Blows Per Minute	Free Speed rpm	Weight		Length		Side To Center		Avg Air Consumption		Socket Retainer Style
	in	mm	in	mm	ft lb	Nm	ft lb	Nm			lb	kg	in	mm	in	mm	cfm	l/s	
IW50HAP-4F	1/2	13	3/8	16	100-450	135-610	550	745	1140	7000	4.3	1.9	7.6	192	1.3	33	4	2	Ring
IW50HAP-4P	1/2	13	3/8	16	100-450	135-610	550	745	1140	7000	4.3	1.9	7.6	192	1.3	33	4	2	Pin
IW38TBP-3P	3/8	10	1/4	6	10-70	13-95	70	95	2000	8000	2.1	1.0	6.3	160	0.9	22	2	1	Pin
IW38HAP-3F	3/8	10	3/8	10	60-200	80-270	250	340	1380	10000	3.3	1.5	6.7	170	1.1	28	2	1	Ring
IW38HAP-3P	3/8	10	3/8	10	60-200	80-270	250	340	1380	10000	3.3	1.5	6.7	170	1.1	28	2	1	Pin
IW38HAP-4F	1/2	13	3/8	10	60-200	80-270	250	340	1380	10000	3.3	1.5	6.7	170	1.1	28	2	1	Ring
IW38HAP-4P	1/2	13	3/8	10	60-200	80-270	250	340	1380	10000	3.3	1.5	6.7	170	1.1	28	2	1	Pin
IW500MP-4R	1/2	13	3/8	10	100-624	135-845	780	1058	1200	9400	4.2	1.9	7	178	1.5	38	4	2	Ring
IW500MP-4P	1/2	13	3/8	10	100-624	135-845	780	1058	1200	9400	4.2	1.9	7	178	1.5	38	4	2	Pin

¹ Maximum working torque determined by 5 second rundown on appropriate Skidmore-Wilhelm Torque-Tension Tester.

General: Air Inlet Size: 1/4" NPT • Recommended Hose Size: 3/8" (10 mm) • Performance rated @ 90 psig (6.2 bar) air pressure

Standard Equipment: Parts List • Safety and Instruction Manual • Suspension Bail

Accessories: Impact Wrench Accessories, see page 685



IW375AP-3P

KEY FEATURES:

High power to weight ratio
 High impact rate of 5,000 blows per minute
 Working torque range up to 95 ft/lbs
 Extended life through bearing design
 Smooth Impacting that creates minimal torque reaction
 Includes rubber boot for hammer case

APPLICATIONS:

Wood Screws
 Self-tapping screws
 Lag bolts
 High prevailing torque applications

3/8" Pinned Anvil

3/8" Friction Ring Anvil



3/8" [10 MM] IMPACT WRENCH

Model Number	Drive Size		Working Torque Range ¹		Maximum Torque		Blows Per Minute	Free Speed rpm	Weight		Length		Side To Center		Socket Retainer Style	
	in	mm	ft lb	Nm	ft lb	Nm			lb	kg	in	mm	in	mm		
Pistol Grip																
IW375AP-3P	3/8	10	10-95	13-130	100	135	5000	4000	2.5	1.1	8.5	216	0.85	21	Pin	
IW375AP-3F	3/8	10	10-95	13-130	100	135	5000	4000	2.5	1.1	8.5	216	0.85	21	Ring	

¹ Maximum working torque determined by 5 second rundown on appropriate Skidmore-Wilhelm Torque-Tension Tester.

General: Air Inlet Size: 1/4" NPT • Recommended Hose Size: 3/8" (10 mm) • Performance rated @ 90 psig (6.2 bar) air pressure

Standard Equipment: Parts List • Safety and Instruction Manual

Accessories: Impact Wrench Accessories, see page 685





IW100HAI-8H



IW1000MP-8H



IW75BP-6H

PERFORMANCE:

Working Torque: 800 ft lb (1085 Nm) – 2500 ft lb (3390 Nm)
 Drive Size: 3/4" (19 mm) – 1-1/2" (38 mm)
 Bolt Capacity: 3/4" (19 mm) – 2" (50 mm)

FEATURES:

Pistol Grip and D-Handle
 Inside and Outside Trigger (D-Handle Models)
 Steel Anvil Housing

3/4" [19 MM], 1" [25 MM], 1-1/2" [38 MM] IMPACT WRENCHES



Model Number	Drive Size		Bolt Cap Grade 5		Maximum Working Torque ¹		Maximum Torque		Blows Per Minute	Free Speed rpm	Weight		Length		Side To Center		Avg Air Consumption		Socket Retainer Style
	in	mm	in	mm	ft lb	Nm	ft lb	Nm			lb	kg	in	mm	in	mm	cfm	l/s	
Pistol Grip																			
IW75BP-6H	3/4	19	3/4	19	800	1085	1000	1356	1000	5700	11.6	5.3	7.6	193	1.75	45	15	7	Hole
IW75BP-8H	1	25	3/4	19	825	1119	1100	1492	1000	5700	11.7	5.3	7.6	193	1.75	45	15	7	Hole
D-Handle – Inside Trigger																			
IW1000MP-8H	1	25	1 1/4	32	1200	1630	1700	2300	825	6500	18.2	8.3	14.8	376	1.85	47	34	16	Hole/Ring
IW1000MP-8H5	1	25	1 1/4	32	1200	1630	1700	2300	825	6500	19.7	8.9	19.3	490	1.85	47	34	16	Hole/Ring
IW100HAI-8H	1	25	1 3/8	35	1600	2170	2000	2710	850	5000	22	10	12.4	315	2	51	38	18	Hole
IW100HAI-8H6	1	25	1 3/8	35	1600	2170	2000	2710	850	5000	26.2	11.8	18.4	467	2	51	38	18	Hole
IW100HAI-5S		#5 Spline	1 3/8	35	1600	2170	2000	2710	850	5000	22	10	12.4	315	2	51	38	18	Hole
IW100HAI-5S6		#5 Spline	1 3/8	35	1600	2170	2000	2710	850	5000	26.2	11.8	18.4	467	2	51	38	18	Hole
IW150HAI-5S		#5 Spline	2	50	2500	3390	3000	4070	650	3750	33	15	14.5	368	2.5	65	60	28	Hole
IW150HAI-12H	1 1/2	38	2	50	2500	3390	3000	4070	650	3750	33.1	15	14.5	368	2.5	65	60	28	Hole
D-Handle – Outside Trigger																			
IW100HAO-8H	1	25	1 3/8	35	1600	2170	2000	2710	850	5000	22	10	12.4	315	2	51	38	18	Hole
IW100HAO-8H6	1	25	1 3/8	35	1600	2170	2000	2710	850	5000	26.2	11.8	18.4	467	2	51	38	18	Hole
IW100HAO-5S		#5 Spline	1 3/8	35	1600	2170	2000	2710	850	5000	22	10	12.4	315	2	51	38	18	Hole
IW100HAO-5S6		#5 Spline	1 3/8	35	1600	2170	2000	2710	850	5000	26.2	11.8	18.4	467	2	51	38	18	Hole
IW150HAO-5S		#5 Spline	2	50	2500	3390	3000	4070	650	3750	33	15	14.5	368	2.5	65	60	28	Hole
IW150HAO-12H	1 1/2	38	2	50	2500	3390	3000	4070	650	3750	33	15	14.5	368	2.5	65	60	28	Hole

¹Maximum working torque determined by 5 second rundown on appropriate Skidmore-Wilhelm Torque-Tension Tester.

General: Air Inlet Size: 3/8" NPT (IW75 series) • Air Inlet Size: 1/2" NPT (IW100 & IW150 series) • Recommended Hose Size: 1/2" (30 mm) • Performance rated @ 90 psig (6.2 bar) air pressure

Standard Equipment: Parts List • Safety and Instruction Manual • Suspension Bail (IW75 models) • Support handle (D-Handle models)

Accessories: Impact Wrench Accessories, see page 685

PERFORMANCE:

Maximum Torque: 1050 ft lb (1423 Nm)
 Drive Size: 3/4" (19 mm)

FEATURES:

Light weight composite housing with aluminum nose
 Increased power through motor & impact mechanism designs
 Grease Clutch
 Reverse biased
 One hand Forward / Reverse operation
 Through Hole Retainer
 Pinned Anvil Retainer
 Friction Ring Retainer



IW750MP-6P



HEAVY DUTY IMPACT WRENCHES

Model Number	Drive Size		Maximum Torque		Blows Per Minute	Free Speed rpm	Weight		Length		Air Consumption (Free Speed)		Socket Retainer Style
	in	mm	ft lb	Nm			lb	kg	in	mm	cfm	l/min	
Pistol Grip 3/4" Impact Wrench													
IW750MP-6P	3/4	19	1050	1423	1050	6700	7.5	3.44	8.5	215	5.6	159	Pin
IW750MP-6H	3/4	19	1050	1423	1050	6700	7.5	3.44	8.5	215	5.6	159	Hole
IW750MP-6R	3/4	19	1050	1423	1050	6700	7.5	3.44	8.5	215	5.6	159	Friction Ring

¹Maximum working torque determined by 5 second rundown on appropriate Skidmore-Wilhelm Torque-Tension Tester.

General: 3/4" Anvil: Air Inlet Size: 3/8-18 NPT • Recommended Hose Size: 3/8" (10 mm) • Performance rated @ 90 psig (6.2 bar) air pressure

Accessories: Impact Wrench Accessories, see page 685



IW38TBP-2Q



IW38HAP-7Q

PERFORMANCE:

Torque: 10 ft lb (13 Nm) – 200 ft lb (270 Nm)
 Drive Size: 1/4" (6 mm) hex – 7/16" (11 mm) hex
 Bolt Capacity: 1/4" (6 mm) – 3/8" (10 mm)

FEATURES:

Pistol Grip
 Steel Anvil Housing
 Suspension Bail
 Quick Change Bit Retainer

IMPACT DRIVERS



Model Number	Drive Size		Bolt Cap Grade 5		Working Torque Range ¹		Maximum Torque		Blows Per Minute	Free Speed rpm	Weight		Length		Side To Center		Avg Air Consumption		Socket Retainer Style
	in	mm	in	mm	ft lb	Nm	ft lb	Nm			lb	kg	in	mm	in	mm	cfm	l/s	
Pistol Grip – Trigger Start																			
IW38HAP-7Q	7/16	11	3/8	10	60-200	80-270	250	340	1380	10,000	3.3	1.5	6.7	170	1.1	28	2	1	QC
IW38TBP-2Q	1/4	6	1/4	6	10-70	13-95	70	95	2000	8000	2.1	1	6.3	160	0.9	22	2	1	QC

¹ Maximum working torque determined by 5 second rundown on appropriate Skidmore-Wilhelm Torque-Tension Tester

General: Air Inlet Size: 1/4" NPT • Recommended Hose Size: 3/8" (10 mm) • Performance rated @ 90 psig (6.2 bar) air pressure

Standard Equipment: Parts List • Safety and Instruction Manual • Suspension Bail

Accessories: Impact Driver Accessories, see page 685



ID375AP-2Q



ID375AP-2QRR

KEY FEATURES:

High power to weight ratio
 High impact rate of 5,000 blows per minute
 Working torque range up to 95 ft/lbs
 Extended life through bearing design
 Smooth Impacting that creates minimal torque reaction
 includes rubber boot for hammer case

APPLICATIONS:

Wood Screws
 Self-tapping screws
 Lag bolts
 High prevailing torque applications



1/4" Quick Change

1/4" (6 MM) IMPACT DRIVER



Model Number	Drive Size		Working Torque Range ¹		Maximum Torque		Blows Per Minute	Free Speed rpm	Weight		Length		Side To Center		Socket Retainer Style
	in	mm	ft lb	Nm	ft lb	Nm			lb	kg	in	mm	in	mm	
ID375AP-2Q	1/4	6	10-55	13-75	60	80	5000	4000	2.5	1.1	8.5	216	085	21	Quick Change
ID375AP-2QRR	1/4	6	10-55	13-75	60	80	5000	4000	2.5	1.1	8.5	216	085	21	Quick Change

¹ Maximum working torque determined by 5 second rundown on appropriate Skidmore-Wilhelm Torque-Tension Tester.

General: Air Inlet Size: 1/4" NPT • Recommended Hose Size: 3/8" (10 mm) • Performance rated @ 90 psig (6.2 bar) air pressure

Standard Equipment: Parts List • Safety and Instruction Manual

Accessories: Impact Wrench Accessories, see page 685





CLUTCH SPRINGS



41284

Part Number	Color	Torque Range	
		in lb	Nm
SSD, SD9A, 2 Series Adjustable Clutch			
41284	Green	<25	<2.8
21427	N/A	>25	>2.8
1 Series Adjustable Clutch			
66048	Silver	30-50	3.4-5.7
66049	Blue	15-35	1.7-4
66050	Green	2-20	0.22-2.3
2 Series Torque Control Clutch			
65048	Silver	60-280	6.8-32
65049	Blue	36-180	4.1-20
65050	Green	30-120	3.4-14

POWER TOOLS



66193

COMFORT GRIPS

Part Number	For Use On
66124	1 Series inline (except 2800 rpm)
66193	1 Series inline (2800 rpm)
68340	1 Series pistol grip

ASSEMBLY ACCESSORIES



IW500-3



74994A

TETHER PLATE KITS

Part Number	For Use On
IW500-3	IW500MP
74994A	IW750MP