

Helios expertise in aerodynamics.  
Axial fans without limits.



As one of the leading European fan manufacturers, Helios impresses with extraordinarily large, finely graduated range of high-performance axial, medium-pressure and RADAX® VAR high-pressure fans in all performance ranges.

The next pages present the range for high-performance axial fans with aerodynamic and acoustically optimised impeller and an innovative motor concept (diameter of 250 to 500 mm).

The particularly energy-saving EC models achieve energy savings of over 55% in comparison to conventional AC types thanks to their speed controls.

The AC high-performance axial fans with diameters of 250 to 500 mm and voltage control have an impressive, tried-and-tested and robust design and increase efficiency by 25% while reducing noise by 50%.

The range with diameters of up to 1000 mm is supplemented by solutions for the area of technical building equipment (TGA), see the right hand side.

■ Fire gases and smoke extraction types in accordance with DIN 12101-3 in temperature classes F300 (60 minutes), F400 (120 minutes) and F600 (120 minutes). See separate catalogue.

■ Specialist solutions for technical building equipment (TGA) and large axial fans with diameters from 1000 to 7100 mm, volumes of up to 2.2 million m<sup>3</sup>/h can be produced in accordance with customer-specific requirements. See [www.AxialSoft.de](http://www.AxialSoft.de) for the design.





**HIGH-PERFORMANCE  
AXIAL FANS**  
 Product-specific information  
 and selection chart

Energy-efficient  
 EC version  
 Ø 250 – 500 mm  
 V = 1930 – 8300 m³/h

Standard  
 AC version  
 Ø 200 – 1000 mm  
 V = 520 – 63 420 m³/h

140

142<sup>on</sup>

154<sup>on</sup>

Well-known users from all over the world trust Helios axial fans for ventilation, heating, cooling and drying applications. Large fans have been used successfully for decades e.g. in cooling towers and condensers.

**MEDIUM PRESSURE  
AXIAL FANS**  
 Product-specific information  
 and selection chart

**RADAX® VAR  
HIGH-PRESSURE FANS**  
 Product-specific information  
 and selection chart

**INSTALLATION  
ACCESSORIES**  
 For axial and RADAX® VAR  
 in-line fans



Ø 225 – 630 mm  
 V = 950 – 26 450 m³/h

Ø 225 – 630 mm  
 V = 900 – 22 310 m³/h

180<sup>on</sup>

206<sup>on</sup>

231<sup>on</sup>



The following information completes the "General Technical Information" section.

■ **Types**

- Helios offer a wide range of products for various applications, i.e. particular help for problem solutions.
- Standard and high-performance fans in industrial design are available as standard in more than 20 standard sizes and more than 1000 types; many of which are shown in this catalogue.
- Closely matched air flow volume and pressure can be achieved on larger fans with a maximum diameter of 7100 mm through adjustable pitch angle. Four standard casing types are available.
- Types HQ, HW and HRF are available up to standard size 500 mm with highly-efficient EC motor technology for particularly energy-saving application and lowest operating costs.

■ **Types in this catalogue**

1. **Wall fan HQ**

**Square plate with inlet cone**  
Casing made from galvanised sheet steel. Motor with terminal box and motor side guard.

2. **Built-in fans**

**HW, AVD DK**  
**Circular plate with inlet cone**  
Casing made from galvanised sheet steel. Motor with terminal box and motor side guard.

3. **Built-in wall fan HS**

**Cylindrical duct case with spigot ends**  
For flush, wall or in-line duct installation. Casing made from galvanised sheet steel with circular stiffening rings.

4. **In-line fans**

**HRF, AVD RK**  
**Cylindrical duct with flanges on both ends**  
For direct in-line installation in ducting. Flanges made to DIN 24155, PT. 3. Casing made from galvanised sheet steel, additional terminal box (IP 55) on outer casing.

■ **Motor**

- AC types  
Robust 1 ph. or 3 ph. internal rotor motor with thermal contacts in the windings. Ball bearings lubricated for life.
- EC types  
Highly-efficient, speed controllable external rotor motor protected to IP 44 or 54. Ball bearings lubricated for life.

■ **Impellers**

- Depending on the performance requirements the impellers are made from various materials; see product pages. The standard design is made from reinforced polymers. Other materials, aluminium or steel, are available on special order.
- All impellers feature:
  - Low noise characteristics.
  - High efficiency.
  - Vibration free operation due to dynamic balancing to DIN ISO 1940 T.1 – grade 6.3.
- Impellers made from other materials are available upon request.
- The standard models are suitable for air flow temperature from -30° to +60 °C. For higher temperatures metal impellers are available to order. See information on the product pages.

■ **Pitch angle**

- The standard products up to 630 mm Ø are equipped with fixed impeller blades.
- Starting from nominal size 710 mm (except type HQW 710/6), the impeller blades are available with order related pitch angles.
- The installation sizes Ø 800/4, 900/4 and ..6 as well as Ø 1000 mm have adjustable blades at standstill. This enables the fan to provide the exact duty required. The pitch angle is factory set (must be stated when ordering). The motors are selected using their maximum performance (see table on product page). The maximum pitch angle shown must not be exceeded as the motor will be overloaded.

■ **Air flow direction**

- All fans (except HRF and AVD RK) come with the air flow direction
- A = pulling air over the motor** as standard. Air flow direction **B = pushing air over the motor** is available for most models with an additional charge. HRF and AVD RK come with air flow direction B as standard.
- The air flow direction can be changed after supply, should it be required, for most AC high-performance axial fans. To do so you have to:
    1. Change the direction of rotation of the motor by changing the terminals on the terminal board.
    2. Remove impeller and put it the opposite way round on the shaft (possible up to Ø 500). Models HQ and HW allow for a 1/3 drop in performance.
  - EC types can only be operated in the set standard direction of rotation.

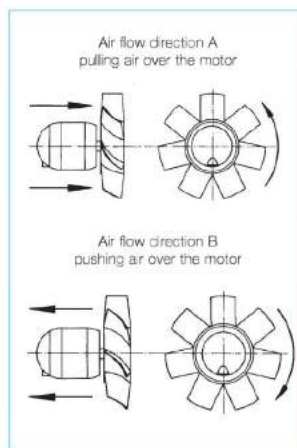

■ **Protection against contact**

All relevant safety instructions and regulations must be followed when the fans are installed. A protection against accidental contact to VDE 0700 and/or DIN EN ISO 13857 must be guaranteed. The contact with rotating parts must be avoided. Make sure that there are no items near the inlet which could be pulled into the fan. Fans which are protected when installed (e.g. in ventilation ducting or closed aggregate) do not require a guard if the system provides sufficient safety. We emphasise that the installer is responsible for the safety of the installation by fitting appropriate protection devices. Suitable guards are available as accessories. The responsibility that all relevant regulations have been observed remains with the installer.

■ **Position, installation, drainage holes**

- Axial fans are suitable for installation in any position. If condensation is to be expected, (e.g. for intermittent operation, high humidity air flow or rapidly changing temperatures) the fan must be installed with the motor drainage holes facing downward and they must be open.
- If installed outdoors, or in wet conditions or if installed with the motor shaft facing vertically upwards, this must be stated when ordering. Please make sure that the fan is fixed securely and the casing is not squeezed or distorted.

■ **Reverse operation**

- Most axial fans are reversible (see product page). Using a suitable reversing switch. The fan can be used for intake or extract. In abnormal direction of flow the capacity decreases by approx. 1/3.
- EC types are not reversible as standard.

■ **Air flow temperatures**

The standard models are suitable for temperatures from -30 °C to +40 °C or +60 °C (AC or EC types). Apart from explosion proof fans, higher temperatures are possible for a short time. For permanently higher temperatures special models are available on request.

■ **Motor protection**

- For AC types; through thermal contacts in the windings
  - standard for 1 ph. motors,
  - mostly standard for 3 ph. motors (see product page).
- For EC types; integrated electronic temperature monitoring.

■ **Explosion protection**

The ex-proof models conform to cluster II, category 2G for operation in zone 1 or 2. According to directive 2014/34/EU (ATEX), larger air gaps are specified which lead to a capacity reduction of up to 10%.

■ **Extra equipment, additional charge on demand**

- Aluminium cast impeller
- Alternative voltage
- Alternative frequency
- Two pack coating for protection of external components against diluted acids and lime solutions
- Alternative air flow direction
- Extra equipment for higher air flow temperatures
- Pressure-tight encapsulated motors (standard for 1 ph. ex-proof types)

■ **Anti vibration insulation**

To avoid vibration transmission to building and ducting the use of anti vibration mounts (accessory SDD, SDZ) is highly recommended. Larger frame size motors may protrude out of the casing and might move the centre of gravity within the fan. To avoid an uneven load on the anti vibration mounts, an extension duct is recommended (accessory VR).





By combining the parameters of static pressure increase  $\Delta p_{st}$ , air flow volume  $V$ , speed  $\text{min}^{-1}$ , sound pressure level  $\text{dB(A)}$  and impeller diameter DN mm, the following table facilitates the selection of EC high-performance

axial fans  $\varnothing$  250 to 500 mm and high-performance axial fans  $\varnothing$  200 to 1000 mm.

Diameter mm	R.P.M. min <sup>-1</sup>	Sound press. Intake L <sub>PA</sub> dB(A) in 4 m	Air flow volume $V \text{ m}^3/\text{h}$ depending on static pressure ( $\Delta P_{st}$ ) in Pa																
			0	10	20	30	40	50	60	80	100	120	140	160	200	250	300	350	400
			EC 250	2300	56	1930	1880	1820	1760	1700	1630	1550	1370	1070					
EC 315	1650	52	3110	3000	2880	2760	2640	2520	2400	2090	1680								
EC 355 A	1200	50	3220	3050	2870	2700	2520	2330	2090										
EC 355 B	1975	59	4200	4150	4090	4020	3960	3890	3820	3690	3540	3360	3100	2790					
EC 400 A	1800	59	4790	4690	4610	4540	4460	4390	4310	4140	3920	3640	3240						
EC 400 B	2150	65	5850	5800	5760	5700	5640	5560	5490	5360	5210	5080	4870	4730	4030				
EC 450 A	1325	55	5460	5350	5250	5140	5030	4910	4790	4520	4200	3730							
EC 450 B	1835	64	7640	7580	7510	7450	7390	7330	7260	7070	6880	6680	6490	6200	5530				
EC 500 A	1025	54	6320	6190	6050	5900	5750	5590	5420	5010	4460								
EC 500 B	1450	62	8300	8230	8150	8070	7970	7880	7790	7490	7300	6910	6530	6140					

Diameter mm	R.P.M. min <sup>-1</sup>	Sound press. Intake L <sub>PA</sub> dB(A) in 4 m	Air flow volume $V \text{ m}^3/\text{h}$ depending on static pressure ( $\Delta P_{st}$ ) in Pa																
			0	10	20	30	40	50	60	80	100	120	140	160	200	250	300	350	400
			200	2300	55	910	860	810	760	710	490	420	330	220					
200	1360	42	520	410	210	170													
250	2800	53	2070	2040	2010	1970	1940	1910	1870	1800	1710	1610	1480						
250	1450	44	930	840	730														
250	950	31	660	570															
315	2800	69	4090	4050	4020	3990	3950	3920	3880	3790	3700	3610	3500	3380	3090				
315	1450	51	2090	2010	1930	1840	1740	1620	1410										
315	950	38	1330	1220	1070														
315	725	30	980	780															
355	2800	71	5710	5670	5620	5580	5530	5480	5430	5330	5220	5110	4990	4860	4550	4020			
355	1450	51	2850	2770	2670	2570	2450	2320	2160										
355	950	42	1940	1830	1690	1500	1060												
355	725	34	1430	1240	880														
400	2800	71	8410	8360	8310	8270	8220	8170	8130	8030	7940	7840	7750	7650	7440	7160	6840	6440	5820
400	1450	56	4010	3920	3810	3700	3580	3440	3300	2970									
400	950	45	2570	2410	2230	2020													
400	725	37	2010	1810	1530														
450	2800	78	11050	10960	10870	10770	10680	10590	10500	10310	10130	9950	9770	9580	9210	8690	8050	6930	4520
450	1450	58	5770	5680	5590	5500	5390	5280	5160	4870	4510	4010							
450	950	47	3890	3720	3550	3360	3150	2890											
450	725	51	2860	2680	2450	2120													
500	2800	81	13150	13040	12930	12820	12720	12610	12500	12290	12070	11860	11660	11440	11010	10380	9600	8620	5390
500	1450	65	8320	8220	8110	8000	7880	7760	7630	7370	7080	6760	6400	5970					
500	950	51	5500	5330	5140	4950	4740	4510	4240	3450									
500	725	44	3890	3690	3440	3150	2750												
560	1450	62	12910	12680	12550	12360	12140	11950	11770	11320	10900	10550	10000	9500	8270				
560	950	52	8100	7680	7370	7080	6680	6280	5830	4570									
560	725	46	6450	6070	5640	5230	4750	4140											
630	1450	65	17870	17650	17420	17200	16970	16750	16520	16010	15500	15000	14500	14000	13000	11300			
630	950	55	10520	10150	9790	9410	9040	8670	8220	7260									
630	725	49	8000	7580	7010	6530	5910	5300											
710	1450	71	23740	23490	23240	22980	22730	22470	22200	21660	21090	20500	19900	19290	18010	16240	14000	11060	
710	935	61	15250	14860	14450	14040	13590	13140	12600	11690	10610	9280	7440						
710	700	54	11350	10810	10250	9630	8990	8300	7500	5340									
800	1435	73	32350	32040	31720	31400	31090	30770	30490	29860	29230	28610	27990	27330	25940	24020	22080		
800	945	62	20720	20280	19830	19350	18850	18290	17710	16530	15330	13840	10740						
800	705	55	15380	14780	14120	13380	12580	11790	10900										
900	1435	76	46060	45700	45390	45030	44670	44310	44000	43280	42600	41880	41170	40800	39060	37110	34940	32800	30340
900	950	66	30500	30100	29500	29100	28500	27900	27400	26300	25100	23910	22710	21310					
900	725	59	21160	20410	19640	18850	18010	17120	16130	15000									
1000	1440	80	63420	63030	62650	62260	61870	61490	61110	60330	59560	58790	58010	57240	55700	53710	51590	49260	46830
1000	950	69	41740	41150	40570	39990	39400	38810	38230	37060	35870	34610	33260	31810	28880				
1000	725	62	31760	30990	30220	29460	28690	27930	27130	25410	23500	21540							



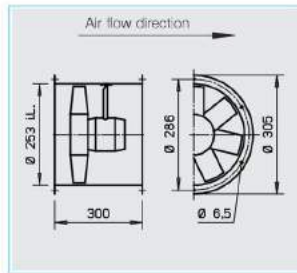
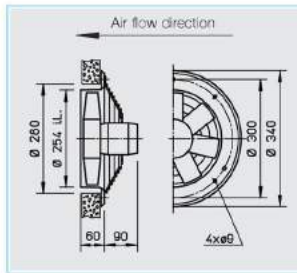
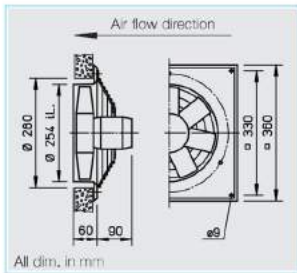

**50% Saving\***  
\* with speed control

**■ Specification for all types**

**□ Casing**

Manufactured in galvanised sheet steel. Models HQ and HW have the additional protection of two coats of papyrus white.

**□ Impeller**

Highly efficient with profiled polymer blades, aerodynamically optimised for application, dynamically balanced. Operating range from -30 to +60 °C.

**□ Motor**

Energy-saving, speed-controllable EC external rotor motor protected to IP 44 with high level of efficiency. Maintenance-free and interference-free, excellent electromagnetic compatibility (EMC), ball bearing mounted.

**□ Motor protection**

Integrated electronic temperature monitoring for EC motor and electronics.

**□ Electrical connection**

Standard terminal box (protection to IP 54) mounted to running cable and on the outside of the ducting for HRF.

**□ Guard**

Made from powder-coated steel for HQ and HW, in accordance with DIN EN ISO 13857.

**□ Speed control**

All types are steplessly controllable through the speed-potentiometer. Furthermore, control is also possible via three-step switch or steplessly via universal control system or electronic differential pressure/temperature controller. See table below, the example performance stages are shown in the characteristic curves.

**□ Installation**

Installation in any position.

**□ Sound levels**

Sum levels and spectrum figures for sound power and sound pressure levels in 4 m free field conditions are specified above the characteristic curve for a medium intake/exhaust operating point. The sound pressure sum level in 4 m (free field conditions) is also shown in the table below and the table below the characteristic curve for different voltages. Sound emissions and room acoustics see page 10.

R.P.M.	Air flow volume (FID)	Motor power	Current	Sound pressure	Wiring diagram	max. air flow temperature	Weight net approx.	Type					
								HQ EC incl. guard	Ref. no.	HW EC incl. guard	Ref. no.	HRF EC	Ref. no.
min <sup>-1</sup>	∇ m <sup>3</sup> /h	kW	A	dB(A) in 4 m	No.	+°C	kg						
<b>1 ph. motor, 1~ 230 Volt, 50/60 Hz, EC motor, protection to IP 44</b>													
2650	1930	0.13	0.97	56	1046	40	6.5	HQW EC 250 A	4822	HWW EC 250 A	4823	HRFW EC 250 A	4824





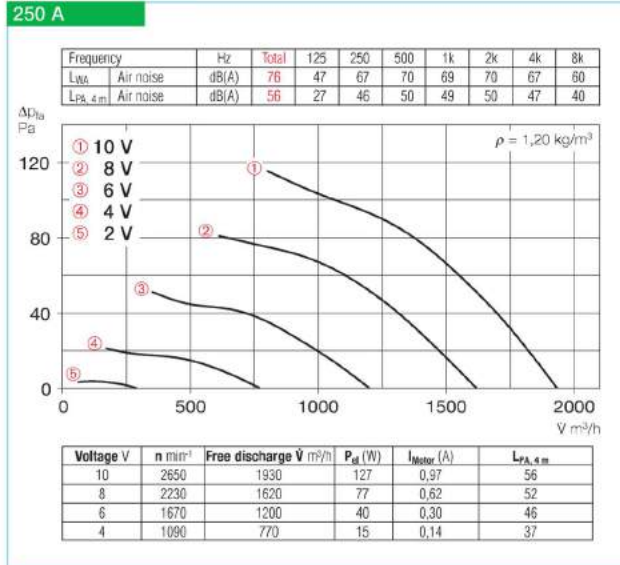

Accessories for HRF EC Description see page 231 on

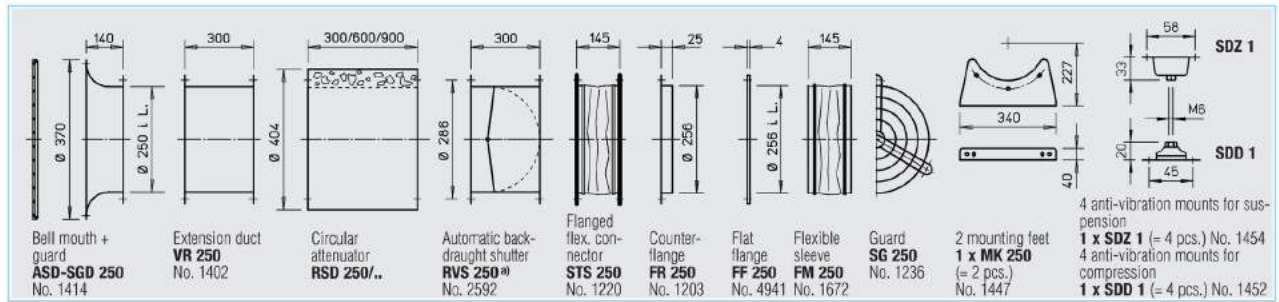

<sup>a)</sup> Motorised backdraught shutter see Accessories product pages

Information	Page
Techn. description	140
Selection chart	141
Information for planning	10 on
<b>Made to order designs</b>	
Alternative voltages, protection classes, air flow direction, air flow temperature, acid protection and cast aluminium impellers are available on request.	
Note the technical information on page 15 on.	

Other accessories	Page
Filters and attenuators	421 on
Backdraught shutters and grilles	487 on
Universal control system, electronic controller, speed-potentiometer	539 on

Universal control system		Speed-potentiometer flush		Speed-potentiometer surface		Three-step speed switch flush		Three-step speed switch surface		Electronic diff. pressure controller/switch		Electronic temperature controller/switch	
Type	Ref. no.	Type	Ref. no.	Type	Ref. no.	Type	Ref. no.	Type	Ref. no.	Type	Ref. no.	Type	Ref. no.
EUR EC <sup>1)</sup>	1347	PU 10 <sup>1)</sup>	1734	PA 10 <sup>1)</sup>	1735	SU-3 10 <sup>1)</sup>	4266	SA-3 10 <sup>1)</sup>	4267	EDR <sup>1)</sup>	1437	ETR <sup>1)</sup>	1438

<sup>1)</sup> Several EC fans can normally be connected, see Accessories



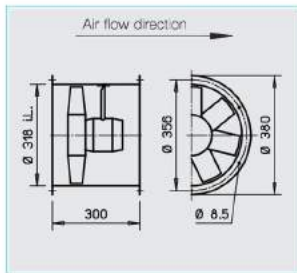
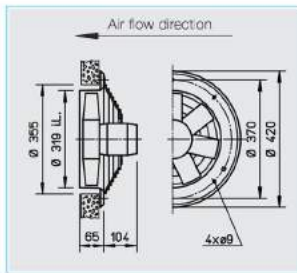
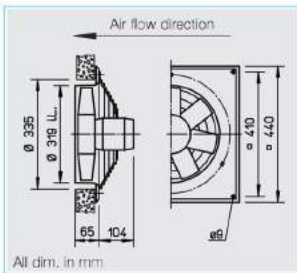

**■ Specification for all types**

- Casing**  
Manufactured in galvanised sheet steel. Models HQ and HW have the additional protection of two coats of papyrus white.
- Impeller**  
Highly efficient with profiled polymer blades, aerodynamically optimised for application, dynamically balanced. Operating range from -30 to +60 °C.
- Motor**  
Energy-saving, speed-controlable EC external rotor motor protected to IP 44 with high level of efficiency. Maintenance-free and interference-free, excellent electromagnetic compatibility (EMC), ball bearing mounted.
- Motor protection**  
Integrated electronic temperature monitoring for EC motor and electronics.

- Electrical connection**  
Standard terminal box (protection to IP 54) mounted to running cable and on the outside of the ducting for HRF.
- Guard**  
Made from powder-coated steel for HQ and HW, in accordance with DIN EN ISO 13857.
- Speed control**  
All types are steplessly controlable through the speed-potentiometer. Furthermore, control is also possible via three-step switch or steplessly via universal control system or electronic differential pressure/temperature controller. See table below, the example performance stages are shown in the characteristic curves.

- Installation**  
Installation in any position.
- Sound levels**  
Sum levels and spectrum figures for sound power and sound pressure levels in 4 m free field conditions are specified above the characteristic curve for a medium intake/exhaust operating point. The sound pressure sum level in 4 m (free field conditions) is also shown in the table below and the table below the characteristic curve for different voltages. Sound emissions and room acoustics see page 10.

R.P.M.	Air flow volume (FID)	Motor power	Current	Sound pressure	Wiring diagram	max. air flow temperature	Weight net approx.	Type					
								HQ EC incl. guard	Ref. no.	HW EC incl. guard	Ref. no.	HRF EC	Ref. no.
<b>1 ph. motor, 1- 230 Volt, 50/60 Hz, EC motor, protection to IP 44</b>													
2040	3110	0.19	1.50	52	1046	40	8.0	HQW EC 315 A	4880	HWW EC 315 A	4881	HRFW EC 315 A	4882



### 315 A

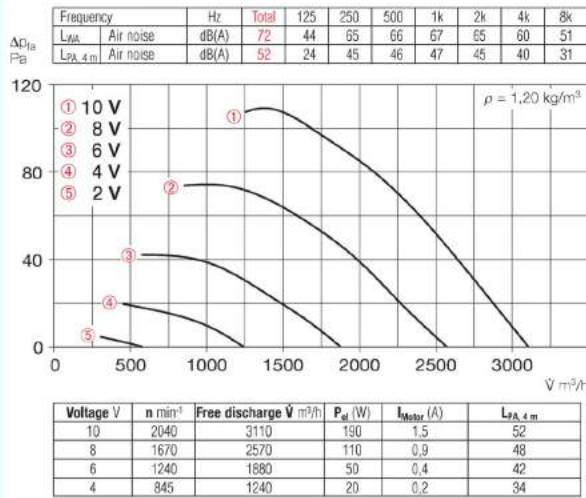

Accessories for HRF EC Description see page 231 on

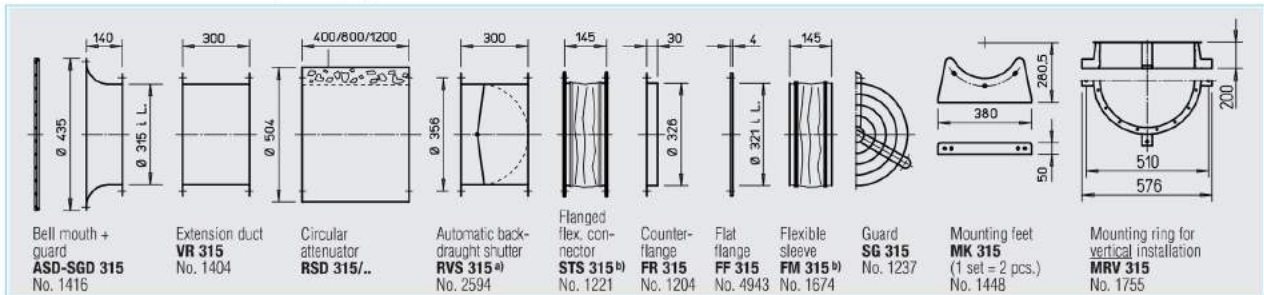

<sup>a)</sup> Motorised backdraught shutter see Accessories product pages

Information	Page
Techn. description	140
Selection chart	141
Information for planning	10 on

**Made to order designs**  
Alternative voltages, protection classes, air flow direction, air flow temperature, acid protection and cast aluminium impellers are available on request.

Note the technical information on page 15 on.

Other accessories	Page
Filters and attenuators	421 on
Backdraught shutters and grilles	487 on
Universal control system, electronic controller, speed-potentiometer	539 on

Universal control system		Speed-potentiometer flush			Three-step speed switch flush		Electronic diff. pressure controller/switch		Electronic temperature controller/switch				
Type	Ref. no.	Type	Ref. no.	Type	Ref. no.	Type	Ref. no.	Type	Ref. no.	Type	Ref. no.		
EUR EC <sup>1)</sup>	1347	PU 10 <sup>1)</sup>	1734	PA 10 <sup>1)</sup>	1735	SU-3 10 <sup>1)</sup>	4266	SA-3 10 <sup>1)</sup>	4267	EDR <sup>1)</sup>	1437	ETR <sup>1)</sup>	1438

<sup>1)</sup> Several EC fans can normally be connected, see Accessories





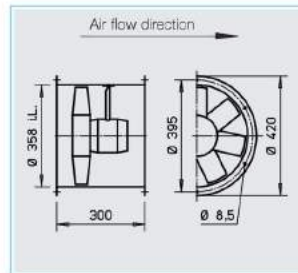
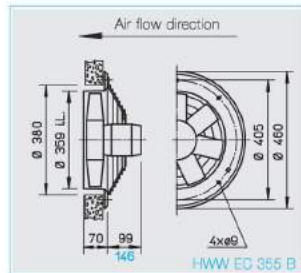
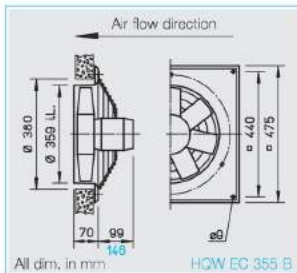

**50% Saving \***  
\* with speed control

**■ Specification for all types**

- Casing**  
Manufactured in galvanised sheet steel. Models HQ and HW have the additional protection of two coats of papyrus white.
- Impeller**  
Highly efficient with profiled polymer blades, aerodynamically optimised for application, dynamically balanced. Operating range from -30 to +60 °C.
- Motor**  
Energy-saving, speed-controllable EC external rotor motor protected to IP 44 (type A), IP 54 (Type B) with high level of efficiency. Maintenance-free and interference-free, excellent electromagnetic compatibility (EMC), ball bearing mounted.
- Motor protection**  
Integrated electronic temperature monitoring for EC motor and electronics.

- Electrical connection**  
Standard terminal box (protection to IP 54) For HQ and HW types mounted to running cable ("A") or on the back of the motor ("B"). For HRF types on the outside of the ducting.
- Guard**  
Made from powder-coated steel for HQ and HW, in accordance with DIN EN ISO 13857.
- Speed control**  
All types are steplessly controllable through the speed-potentiometer. Furthermore, control is also possible via three-step switch or steplessly via universal control system or electronic differential pressure/temperature controller. See table below, the example performance stages are shown in the characteristic curves.

- Installation**  
Installation in any position.
- Sound levels**  
Sum levels and spectrum figures for sound power and sound pressure levels in 4 m free field conditions are specified above the characteristic curve for a medium intake/exhaust operating point. The sound pressure sum level in 4 m (free field conditions) is also shown in the table below and the table below the characteristic curve for different voltages. Sound emissions and room acoustics see page 10.

R.P.M.	Air flow volume (FID)	Motor power	Current	Sound pressure	Wiring diagram	max. air flow temperature	Weight net approx.	Type					
								HQ EC incl. guard	Ref. no.	HW EC incl. guard	Ref. no.	HRF EC	Ref. no.
min <sup>-1</sup>	V m <sup>3</sup> /h	kW	A	dB(A) in 4 m	No.	+°C	kg						
<b>1 ph. motor, 1~ 230 Volt, 50/60 Hz, EC motor, protection to IP 44</b>													
1500	3220	0.15	1.20	50	1046	40	9.0	HQW EC 355 A	4916	HWW EC 355 A	4917	HRFW EC 355 A	4918
1800	4200	0.32	1.40	59	1047	40	12.0	HQW EC 355 B	4919	HWW EC 355 B	4920	HRFW EC 355 B	4921



### 355 A

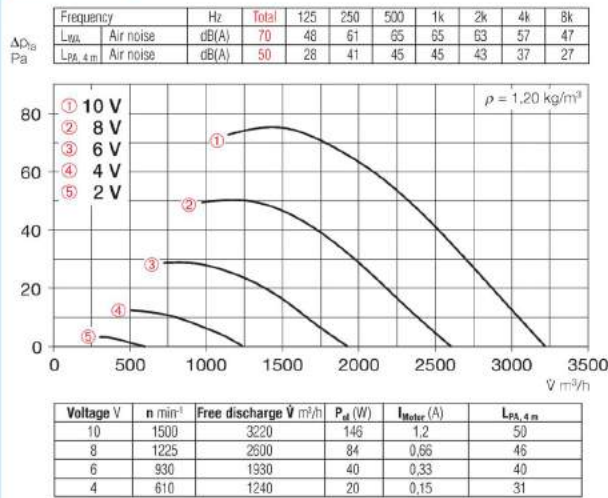

### 355 B

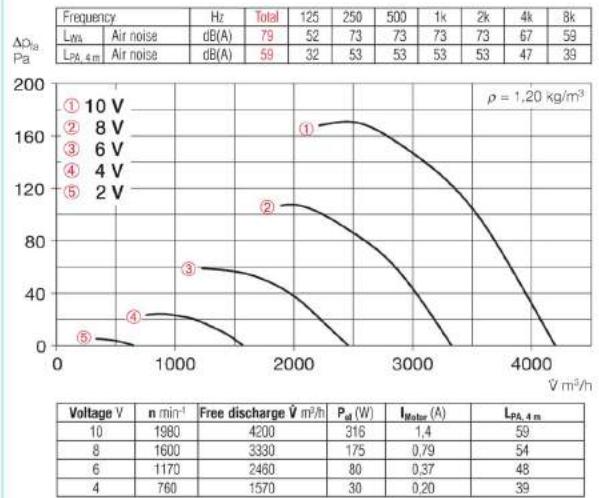

Accessories for HRF EC Description see page 231 on

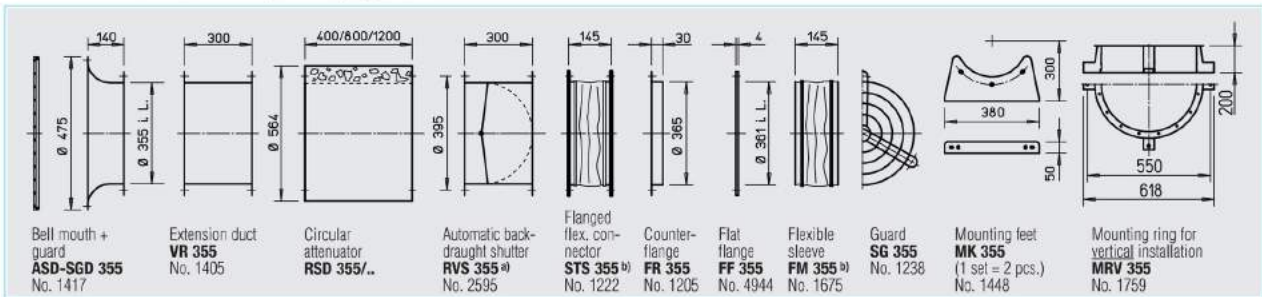

<sup>a)</sup> Motorised backdraught shutter see Accessories product pages

Information	Page	Other accessories	Page
Techn. description	140	Filters and attenuators	421 on
Selection chart	141	Backdraught shutters and grilles	487 on
Information for planning	10 on	Universal control system, electronic controller, speed-potentiometer	539 on

**Made to order designs**  
 Alternative voltages, protection classes, air flow direction, air flow temperature, acid protection and cast aluminium impellers are available on request.

Note the technical information on page 15 on.

	Universal control system		Speed-potentiometer flush		Speed-potentiometer surface		Three-step speed switch flush		Three-step speed switch surface		Electronic diff. pressure controller/switch		Electronic temperature controller/switch	
	Type	Ref. no.	Type	Ref. no.	Type	Ref. no.	Type	Ref. no.	Type	Ref. no.	Type	Ref. no.	Type	Ref. no.
EUR EC <sup>1)</sup>	1347	1347	PU 10 <sup>1)</sup>	1734	PA 10 <sup>1)</sup>	1735	SU-3 10 <sup>1)</sup>	4266	SA-3 10 <sup>1)</sup>	4267	EDR <sup>1)</sup>	1437	ETR <sup>1)</sup>	1438
EUR EC <sup>1)</sup>	1347	1347	PU 10 <sup>1)</sup>	1734	PA 10 <sup>1)</sup>	1735	SU-3 10 <sup>1)</sup>	4266	SA-3 10 <sup>1)</sup>	4267	EDR <sup>1)</sup>	1437	ETR <sup>1)</sup>	1438

<sup>1)</sup> Several EC fans can normally be connected, see Accessories





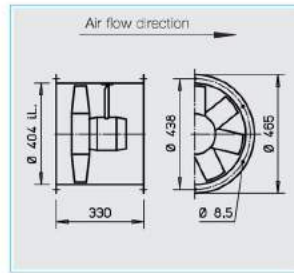
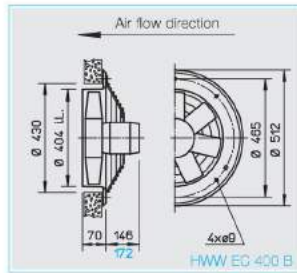
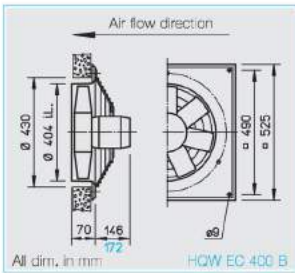

**■ Specification for all types**

**□ Casing**

Manufactured in galvanised sheet steel. Models HQ and HW have the additional protection of two coats of papyrus white.

**□ Impeller**

Highly efficient with profiled polymer blades, aerodynamically optimised for application, dynamically balanced. Operating range from -30 to +60 °C.

**□ Motor**

Energy-saving, speed-controllable EC external rotor motor protected to IP 54 with high level of efficiency. Maintenance-free and interference-free, excellent electromagnetic compatibility (EMC), ball bearing mounted.

**□ Motor protection**

Integrated electronic temperature monitoring for EC motor and electronics.

**□ Electrical connection**

Standard terminal box (protection to IP 54) For HQ and HW types mounted to running cable ("A") or on the back of the motor ("B"). For HRF types on the outside of the ducting.

**□ Guard**

Made from powder-coated steel for HQ and HW, in accordance with DIN EN ISO 13857.

**□ Speed control**

All types are steplessly controllable through the speed-potentiometer. Furthermore, control is also possible via three-step switch or steplessly via universal control system or electronic differential pressure/temperature controller. See table below. The example performance stages are shown in the characteristic curves.

**□ Installation**

Installation in any position.

**□ Sound levels**

Sum levels and spectrum figures for sound power and sound pressure levels in 4 m free field conditions are specified above the characteristic curve for a medium intake/exhaust operating point. The sound pressure sum level in 4 m (free field conditions) is also shown in the table below and the table below the characteristic curve for different voltages. Sound emissions and room acoustics see page 10.

R.P.M.	Air flow volume (FID)	Motor power	Current	Sound pressure	Wiring diagram	max. air flow temperature	Weight net approx.	Type					
								HQ EC incl. guard	Ref. no.	HW EC incl. guard	Ref. no.	HRF EC	Ref. no.
min <sup>-1</sup>	∇ m <sup>3</sup> /h	kW	A	dB(A) in 4 m	No.	+°C	kg						
<b>1 ph. motor, 1~ 230 Volt, 50/60 Hz, EC motor, protection to IP 54</b>													
1700	4790	0.32	1.40	59	1047	40	13.4	HQW EC 400 A	4922	HWW EC 400 A	4923	HRFW EC 400 A	4924
2150	5850	0.65	3.10	65	1048	40	15.4	HQW EC 400 B	4925	HWW EC 400 B	4926	HRFW EC 400 B	4927



### 400 A

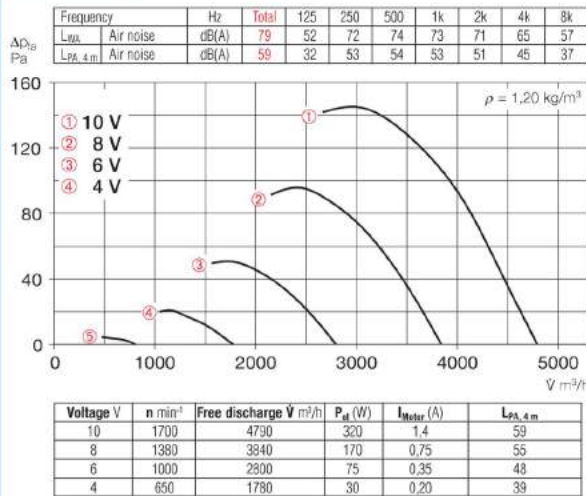

### 400 B

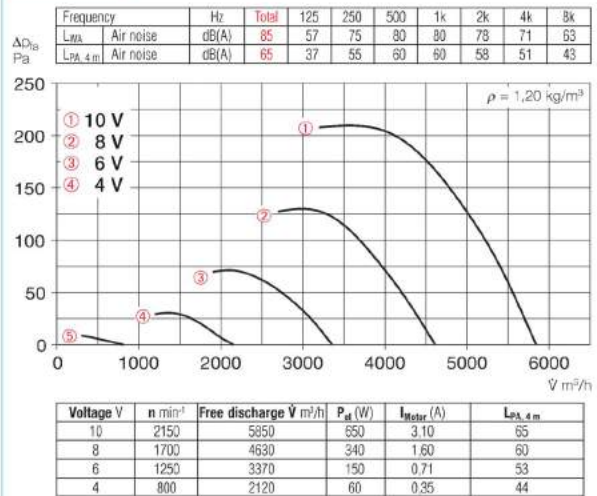

Accessories for HRF EC Description see page 231 on

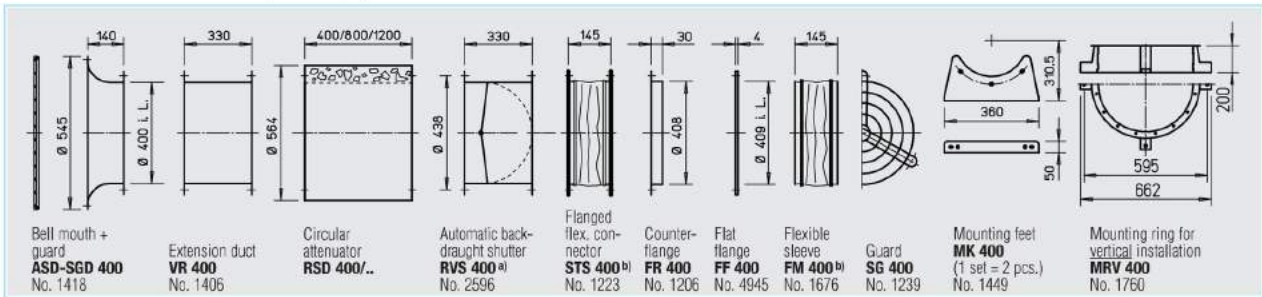

<sup>a)</sup> Motorised backdraught shutter see Accessories product pages

Information	Page
Techn. description	140
Selection chart	141
Information for planning	10 on

**Made to order designs**  
Alternative voltages, protection classes, air flow direction, air flow temperature, acid protection and cast aluminium impellers are available on request.

Note the technical information on page 15 on.

Other accessories	Page
Filters and attenuators	421 on
Backdraught shutters and grilles	487 on
Universal control system, electronic controller, speed-potentiometer	539 on

	Universal control system		Speed-potentiometer flush		Speed-potentiometer surface		Three-step speed switch flush		Three-step speed switch surface		Electronic diff. pressure controller/switch		Electronic temperature controller/switch	
	Type	Ref. no.	Type	Ref. no.	Type	Ref. no.	Type	Ref. no.	Type	Ref. no.	Type	Ref. no.	Type	Ref. no.
EUR EC <sup>1)</sup>	1347	PU 10 <sup>1)</sup>	1734	PA 10 <sup>1)</sup>	1735	SU-3 10 <sup>1)</sup>	4266	SA-3 10 <sup>1)</sup>	4267	EDR <sup>1)</sup>	1437	ETR <sup>1)</sup>	1438	
EUR EC <sup>1)</sup>	1347	PU 10 <sup>1)</sup>	1734	PA 10 <sup>1)</sup>	1735	SU-3 10 <sup>1)</sup>	4266	SA-3 10 <sup>1)</sup>	4267	EDR <sup>1)</sup>	1437	ETR <sup>1)</sup>	1438	

<sup>1)</sup> Several EC fans can normally be connected, see Accessories





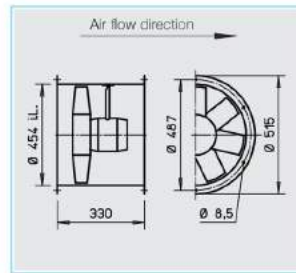
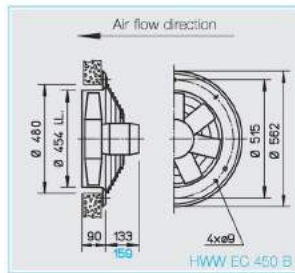
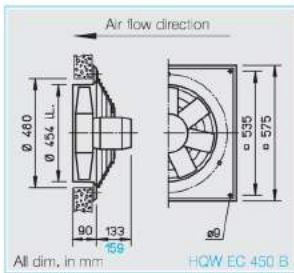

ecgreen Vent **55% Saving \***  
\* with speed control

**■ Specification for all types**

**□ Casing**

Manufactured in galvanised sheet steel. Models HQ and HW have the additional protection of two coats of papyrus white.

**□ Impeller**

Highly efficient with profiled polymer blades, aerodynamically optimised for application, dynamically balanced. Operating range from -30 to +60 °C.

**□ Motor**

Energy-saving, speed-controllable EC external rotor motor protected to IP 54 with high level of efficiency. Maintenance-free and interference-free, excellent electromagnetic compatibility (EMC), ball bearing mounted.

**□ Motor protection**

Integrated electronic temperature monitoring for EC motor and electronics.

**□ Electrical connection**

Standard terminal box (protection to IP 54) For HQ and HW types mounted to running cable ("A") or on the back of the motor ("B"). For HRF types on the outside of the ducting.

**□ Guard**

Made from powder-coated steel for HQ and HW, in accordance with DIN EN ISO 13857.

**□ Speed control**

All types are steplessly controllable through the speed-potentiometer. Furthermore, control is also possible via three-step switch or steplessly via universal control system or electronic differential pressure/temperature controller. See table below. The example performance stages are shown in the characteristic curves.

**□ Installation**

Installation in any position.

**□ Sound levels**

Sum levels and spectrum figures for sound power and sound pressure levels in 4 m free field conditions are specified above the characteristic curve for a medium intake/exhaust operating point. The sound pressure sum level in 4 m (free field conditions) is also shown in the table below and the table below the characteristic curve for different voltages. Sound emissions and room acoustics see page 10.

R.P.M.	Air flow volume (FID)	Motor power	Current	Sound pressure	Wiring diagram	max. air flow temperature	Weight net approx.	Type					
								HQ EC incl. guard	Ref. no.	HW EC incl. guard	Ref. no.	HRF EC	Ref. no.
min <sup>-1</sup>	V m <sup>3</sup> /h	kW	A	dB(A) in 4 m	No.	+°C	kg						
<b>1 ph. motor, 1- 230 Volt, 50/60 Hz, EC motor, protection to IP 54</b>													
1320	5460	0.29	1.30	55	1047	40	14.5	HQW EC 450 A	4928	HWW EC 450 A	4929	HRFW EC 450 A	4930
1835	7640	0.82	3.80	64	1048	40	16.5	HQW EC 450 B	4931	HWW EC 450 B	4932	HRFW EC 450 B	4933



### 450 A

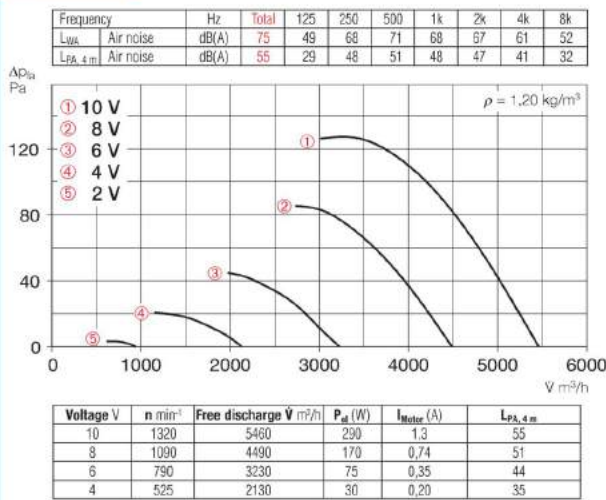

### 450 B

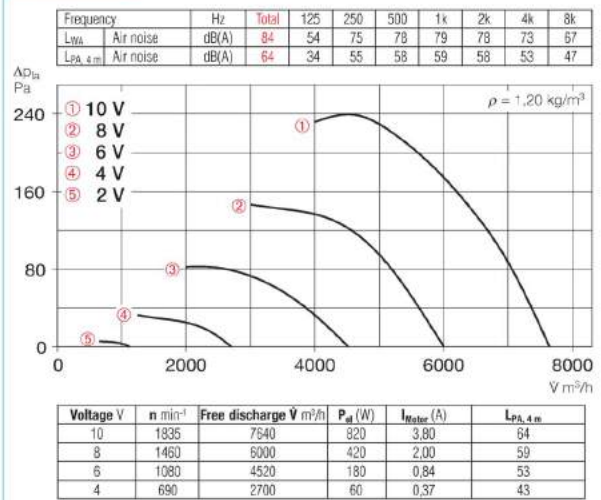

Accessories for HRF EC Description see page 231 on

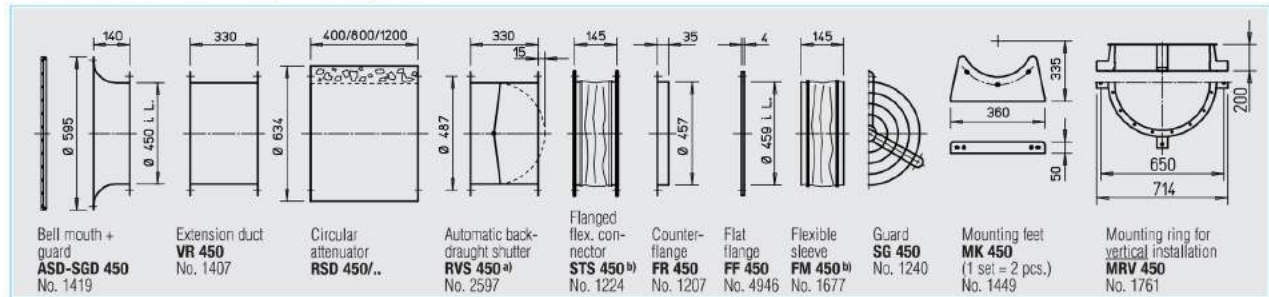

<sup>a)</sup> Motorised backdraught shutter see Accessories product pages

#### Information Page

Techn. description	140
Selection chart	141
Information for planning	10 on

#### Made to order designs

Alternative voltages, protection classes, air flow direction, air flow temperature, acid protection and cast aluminium impellers are available on request.

Note the technical information on page 15 on.

#### Other accessories Page

Filters and attenuators	421 on
Backdraught shutters and grilles	487 on
Universal control system, electronic controller, speed-potentiometer	539 on

Universal control system		Speed-potentiometer flush		Speed-potentiometer surface		Three-step speed switch flush		Three-step speed switch surface		Electronic diff. pressure controller/switch		Electronic temperature controller/switch	
Type	Ref. no.	Type	Ref. no.	Type	Ref. no.	Type	Ref. no.	Type	Ref. no.	Type	Ref. no.	Type	Ref. no.
EUR EC <sup>1)</sup>	1347	PU 10 <sup>1)</sup>	1734	PA 10 <sup>1)</sup>	1735	SU-3 10 <sup>1)</sup>	4266	SA-3 10 <sup>1)</sup>	4267	EDR <sup>1)</sup>	1437	ETR <sup>1)</sup>	1438
EUR EC <sup>1)</sup>	1347	PU 10 <sup>1)</sup>	1734	PA 10 <sup>1)</sup>	1735	SU-3 10 <sup>1)</sup>	4266	SA-3 10 <sup>1)</sup>	4267	EDR <sup>1)</sup>	1437	ETR <sup>1)</sup>	1438

<sup>1)</sup> Several EC fans can normally be connected, see Accessories





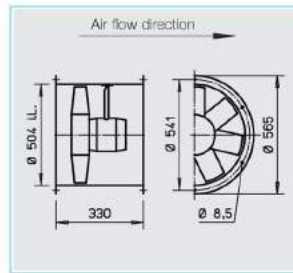
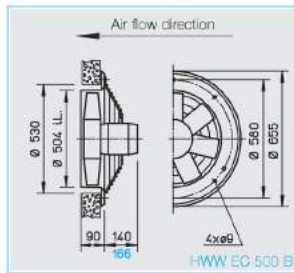
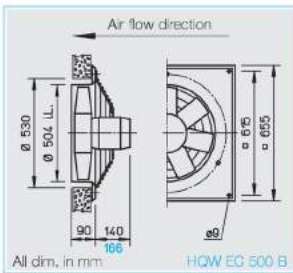

**■ Specification for all types**

**□ Casing**

Manufactured in galvanised sheet steel. Models HQ and HW have the additional protection of two coats of papyrus white.

**□ Impeller**

Highly efficient with profiled polymer blades, aerodynamically optimised for application, dynamically balanced. Operating range from -30 to +60 °C.

**□ Motor**

Energy-saving, speed-controllable EC external rotor motor protected to IP 54 with high level of efficiency. Maintenance-free and interference-free, excellent electromagnetic compatibility (EMC), ball bearing mounted.

**□ Motor protection**

Integrated electronic temperature monitoring for EC motor and electronics.

**□ Electrical connection**

Standard terminal box (protection to IP 54) For HQ and HW types mounted to running cable ("A") or on the back of the motor ("B"). For HRF types on the outside of the ducting.

**□ Guard**

Made from powder-coated steel for HQ and HW, in accordance with DIN EN ISO 13857.

**□ Speed control**

All types are steplessly controllable through the speed-potentiometer. Furthermore, control is also possible via three-step switch or steplessly via universal control system or electronic differential pressure/temperature controller. See table below, the example performance stages are shown in the characteristic curves.

**□ Installation**

Installation in any position.

**□ Sound levels**

Sum levels and spectrum figures for sound power and sound pressure levels in 4 m free field conditions are specified above the characteristic curve for a medium intake/exhaust operating point. The sound pressure sum level in 4 m (free field conditions) is also shown in the table below and the table below the characteristic curve for different voltages. Sound emissions and room acoustics see page 10.

R.P.M.	Air flow volume (FID)	Motor power	Current	Sound pressure	Wiring diagram	max. air flow temperature	Weight net approx.	Type						
								HQ EC incl. guard	Ref. no.	HW EC incl. guard	Ref. no.	HRF EC	Ref. no.	
min <sup>-1</sup>	V m <sup>3</sup> /h	kW	A	dB(A) in 4 m	No.	+°C	kg							
<b>1 ph. motor, 1- 230 Volt, 50/60 Hz, EC motor, protection to IP 54</b>														
1090	6320	0.29	1.30	54	1047	40	15.7	<b>HQW EC 500 A</b>	4934	<b>HWW EC 500 A</b>	4935	<b>HRFW EC 500 A</b>	4936	
1450	8300	0.67	3.00	62	1048	40	17.7	<b>HQW EC 500 B</b>	4937	<b>HWW EC 500 B</b>	4938	<b>HRFW EC 500 B</b>	4939	



### 500 A

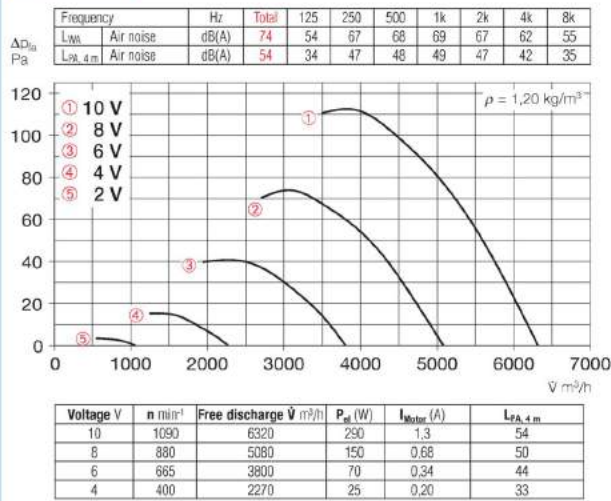

### 500 B

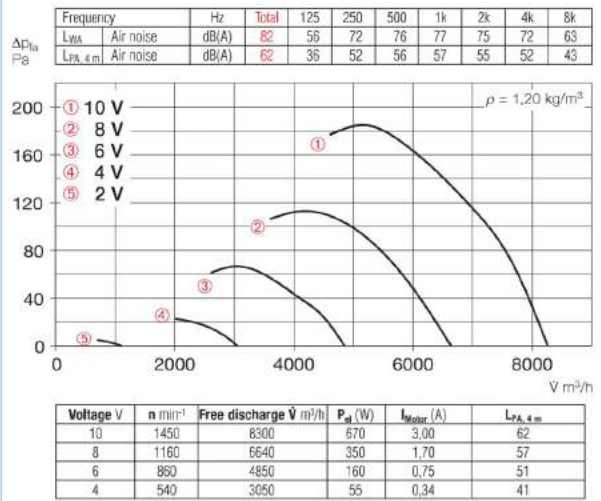

Accessories for HRF EC Description see page 231 on

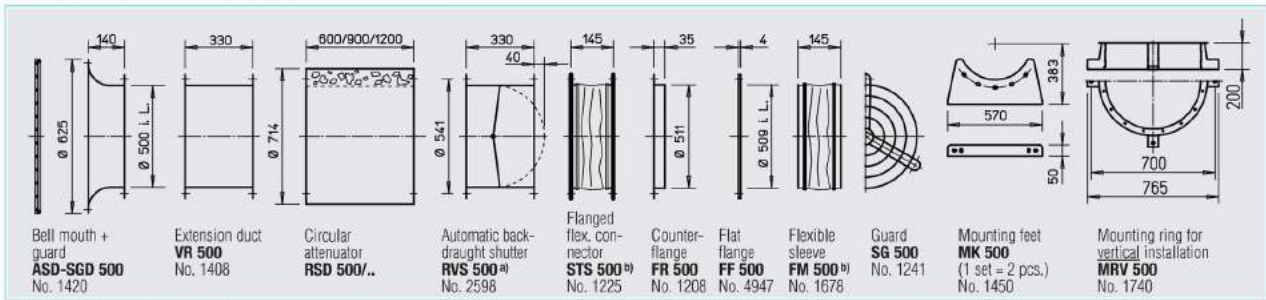

a) Motorised backdraught shutter see Accessories product pages

Information	Page
Techn. description	140
Selection chart	141
Information for planning	10 on
<b>Made to order designs</b>	
Alternative voltages, protection classes, air flow direction, air flow temperature, acid protection and cast aluminium impellers are available on request.	
Note the technical information on page 15 on.	

Other accessories	Page
Filters and attenuators	421 on
Backdraught shutters and grilles	487 on
Universal control system, electronic controller, speed-potentiometer	539 on

Universal control system		Speed-potentiometer flush		Speed-potentiometer surface		Three-step speed switch flush		Three-step speed switch surface		Electronic diff. pressure controller/switch		Electronic temperature controller/switch	
Type	Ref. no.	Type	Ref. no.	Type	Ref. no.	Type	Ref. no.	Type	Ref. no.	Type	Ref. no.	Type	Ref. no.
EUR EC <sup>1)</sup>	1347	PU 10 <sup>1)</sup>	1734	PA 10 <sup>1)</sup>	1735	SU-3 10 <sup>1)</sup>	4266	SA-3 10 <sup>1)</sup>	4267	EDR <sup>1)</sup>	1437	ETR <sup>1)</sup>	1438
EUR EC <sup>1)</sup>	1347	PU 10 <sup>1)</sup>	1734	PA 10 <sup>1)</sup>	1735	SU-3 10 <sup>1)</sup>	4266	SA-3 10 <sup>1)</sup>	4267	EDR <sup>1)</sup>	1437	ETR <sup>1)</sup>	1438

Several EC fans can normally be connected, see Accessories





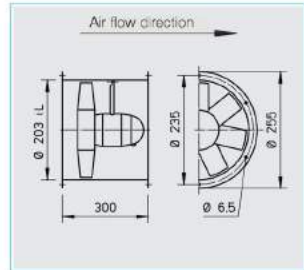
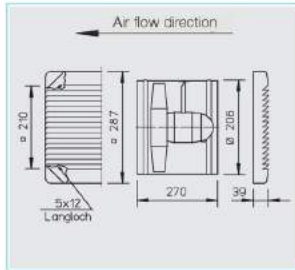
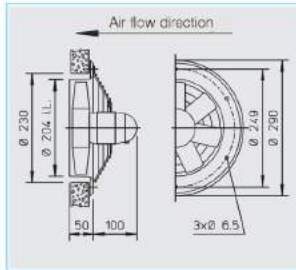
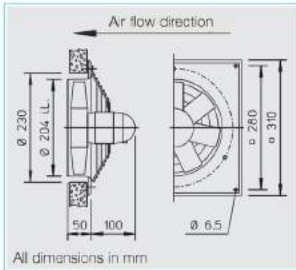

All dimensions in mm

**■ Specification for all models**

**□ Casing**

Manufactured in galvanised sheet steel. Model HQ and HW have an additional two-layer finishing in papyrus white.

**□ Impeller**

Highly efficient, profiled blade impeller, dynamically balanced and manufactured from impact resistant polymers. Suitable for -30 to +60 °C.

**□ Motor**

Totally enclosed motor with a die-cast aluminium casing, protected to IP 54. Ball bearing mounted. Maintenance-free and interference-free. Humidity protection of windings. For maximum air flow temperature see table below.

**□ Motor protection**

All models have automatically resetting thermal contacts wired in series with the motor windings.

**□ Electrical connection**

Terminal box (IP 54) mounted on rear of motor as standard. Also on outside of piping for HRF.

**□ Guard**

Powder-coated steel wire for HQ (Ex-models galvanised) according to DIN EN ISO 13857.

**□ Speed control**

All models are speed controllable by voltage reduction (transformer controller or electronic controller) For according air flow volume see performance curve.

**□ Reversed operation**

All models are reversible when wired to a DSEL reversing switch. For reverse air flow direction allow for 1/3 drop in performance.

**□ Installation**

Installation in any position. Ensure that the motor drainage holes face downwards.

**□ Sound levels**

See characteristic curve. The sound power and sound pressure are specified at 1 m distances under free field conditions, for average operating point suction/pressure side. See page 10 on for sound emission and acoustics.

**■ Information Page**

Techn. description	140
Selection chart	141
Information for planning	10 on

**Made to order designs**

Alternative voltages, protection classes, air flow direction, air flow temperature, acid protection and cast aluminium impellers are available on request.

Note the technical information on page 15 on.

R.P.M.	Air flow volume (FD)	Motor power	Current*		Wiring diagram	max. air flow temp.		Weight net	Model							
			standard-supply	max. controlled		standard supply	speed controlled		HQ incl. guard	Ref. no.	HW incl. guard	Ref. no.	HS incl. guard	Ref. no.	HRF	Ref. no.
min <sup>-1</sup>	∇ m <sup>3</sup> /h	W	A	A	No.	+°C	+°C	kg								
<b>1 Phase motor, 230 Volt / 50 Hz, capacitor motor, protection to IP 54</b>																
1360	520	25	0.11	0.11	439 <sup>1)</sup>	60	40	3.8	<b>HQW 200/4</b>	7537	<b>HWW 200/4</b>	7538	<b>HSW 200/4</b>	7502	<b>HRFW 200/4<sup>1)</sup></b>	7540
1000	930	66	0.26	0.31	439 <sup>1)</sup>	40	40	2.7	<b>HQW 200/2</b>	0960	—	—	<b>HSW 200/2</b>	7503	<b>HRFW 200/2<sup>1)</sup></b>	0199

<sup>1)</sup>HRFW: connect pursuant to wiring diagram no. SS-962.



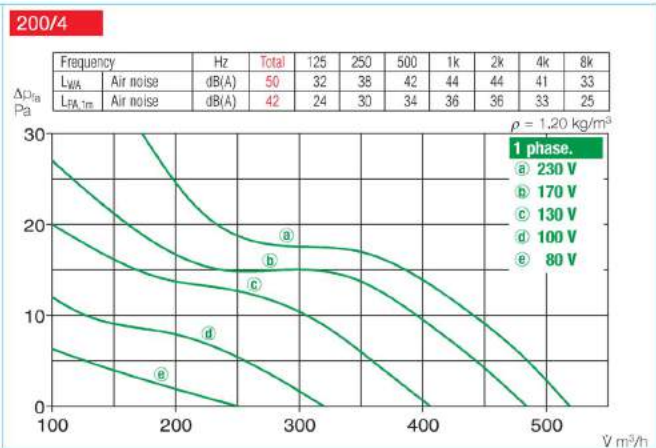
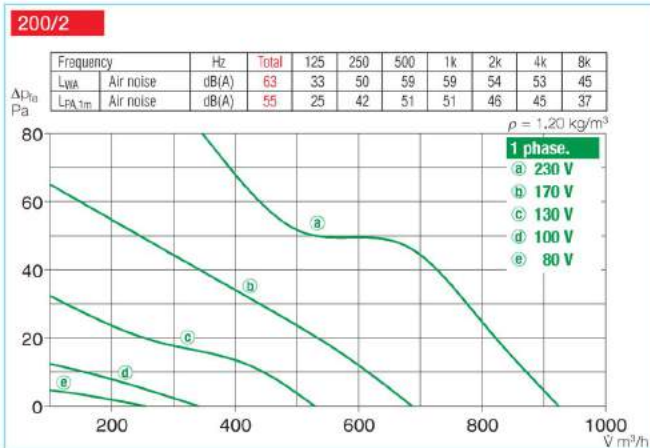

### Accessories for HRF Description see page 230 on

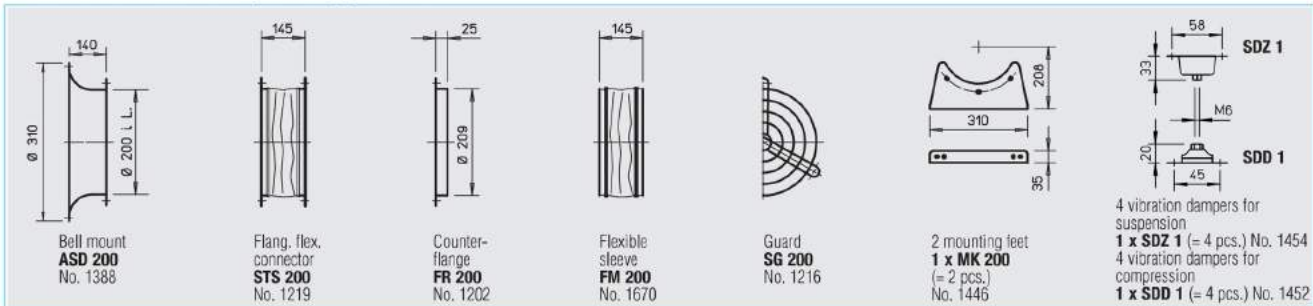

Transformer controller for 5 speed	Electronic controller, stepless flush/surf.	Reversing switch	Electronic controller with reversing switch
<b>Model</b> Ref. no.	<b>Model</b> Ref. no.	<b>Model</b> Ref. no.	<b>Model</b> Ref. no.
<b>TSW 0,3</b> 3608	<b>ESU 1/ESA 1</b> 0236/0238	<b>DSEL 2</b> 1306	<b>BSX</b> 0240
<b>TSW 0,3</b> 3608	<b>ESU 1/ESA 1</b> 0236/0238	<b>DSEL 2</b> 1306	<b>BSX</b> 0240

Other accessories	Page
Extension tube for HS Type VH 200 Cylindrical duct, galvanised steel, length: 150 mm.	Ref. no. 1349
Attenuators	421 on
Shutters and grilles	487 on
Speed controllers and switches	525 on



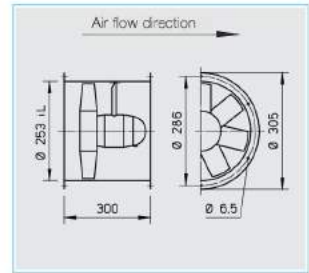
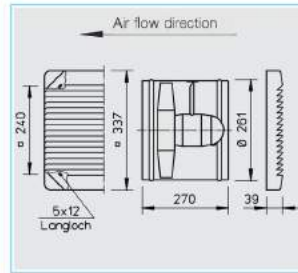
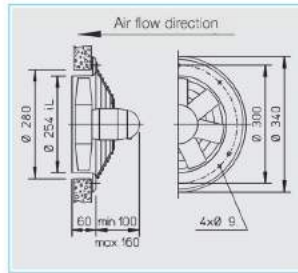
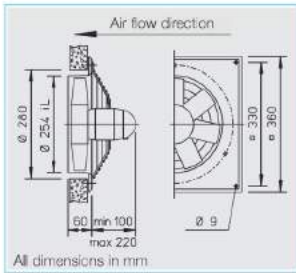

**■ Specification for all models**

**□ Casing**

Manufactured in galvanised sheet steel. Model HQ and HW have an additional two-layer finishing in papyrus white. Ex-models without paint.

**□ Impeller**

Highly efficient, profiled blade impeller, dynamically balanced and manufactured from impact resistant polymers. Suitable for -30 to +60 °C. Deviation for ex-models.

**□ Motor**

Totally enclosed motor with a die-cast aluminium casing, protected to IP 55 or IP 54. Ball bearing mounted. Maintenance-free and interference-free. Humidity protection of windings. For maximum air flow temperature see table below. Deviation for ex-models.

**□ Motor protection**

All models (3- explosion proof excluded) have thermal contacts as standard which must be connected to a motor protection unit (see below). The models H..W 250/6, H..W 250/4 and all 1 ph. ex-proof fans have automatic resetting thermal contacts wired in series with the motor windings.

**□ Electrical connection**

Terminal box (IP 54/55) mounted on rear of motor as standard. Also on outside of piping for HRF. Deviation for ex-models.

**□ Guard**

Powder-coated steel wire for HQ and HW (HQ ex-models galvanised) according to DIN EN ISO 13857.

**□ Speed control**

For all speed controllable models the current are identified with a value in the "speed controlled" column of the table below which must be used when selecting a controller. Possible allocations of frequency inverters are specified in the table below. The planned use of a frequency inverter without Sine filter must be stated when ordering. This requires a change of fan design and potential additional costs. The air flow rates are shown in the performance curves.

**□ Reversed operation**

All models are reversible when wired to a reversing switch. For reverse air flow direction allow a loss in performance of approx. 1/3.

**□ Installation**

Installation in any position. Ensure that the motor drainage holes face downwards.

**□ Dimensions**

Pole-switch and explosion proof models may deviate from the information above.

**□ Sound levels**

See characteristic curve. The sound power and sound pressure are specified at 4 m distances under free field conditions, for average operating point suction/pressure side. See page 10 on for sound emission and acoustics. Deviation for ex-models.

Information	Page
Techn. description	140
Selection chart	141
Information for planning	10 on

R.P.M.	Air flow volume (FID)	Motor power	Current*		Wiring diagram	max. air flow temp.		Weight net	Model							
			standard-supply	max. controlled		standard supply	speed controlled		HQ incl. guard	Ref. no.	HW incl. guard	Ref. no.	HS incl. guard	Ref. no.	HRF	Ref. no.
min <sup>-1</sup>	∇ m <sup>3</sup> /h	W	A	A	No.	+°C	+°C	kg								
<b>1 Phase motor, 230 Volt / 50 Hz, capacitor motor, protection to IP 54/IP 55</b>																
930	660	35	0.20	0.22	317	60	40	6.5	HQW 250/6	1102	—	—	HSW 250/6	0139	—	—
1300	930	36	0.15	0.15	439 <sup>2)</sup>	60	40	7.5	HQW 250/4 <sup>1)</sup>	1103	HWW 250/4 <sup>1)</sup>	1001	HSW 250/4 <sup>1)</sup>	0140	HRFW 250/4 <sup>1)2)</sup>	0200
2710	2070	187	0.81	0.9	317 <sup>3)</sup>	60	40	6.5	HQW 250/2	1104	HWW 250/2	1002	HSW 250/2	0141	HRFW 250/2 <sup>3)</sup>	0201
<b>3 Phase motor, 400 Volt / 50 Hz, squirrel cage motor protection to IP 55</b>																
980	700	61	0.27	0.33	469	60	40	6.5	HQD 250/6	1114	—	—	—	—	—	—
1390	950	55	0.15	0.15	469	60	40	6.5	HQD 250/4 <sup>1)</sup>	1115	HWD 250/4 <sup>1)</sup>	1016	HSD 250/4 <sup>1)</sup>	0155	HRFD 250/4 <sup>1)</sup>	0220
2550	2000	169	0.31	0.33	469	60	40	6.5	HQD 250/2	1116	HWD 250/2	1017	—	—	HRFD 250/2	0221
<b>2 speed motor, pole-switching, Dahlander windings, 400 Volt, 50 Hz, protection to IP 55</b>																
1430/2770	1030/2110	58/212	0.16/0.43		472	60	—	8.5	HQD 250/4/2	1128	—	—	—	—	HRFD 250/4/2	0390
<b>Explosion proof Ex d II B, 1 ph., 230 Volt, 50 Hz, protection to IP 55, temp. class T1-T3</b>																
1400	1030	60*	0.70*		757	40	—	12	HQW 250/4 Ex	0438	—	—	—	—	HRFW 250/4 Ex	0437
2690	1950	180*	1.23*		757	40	—	13	HQW 250/2 Ex	1094	—	—	—	—	HRFW 250/2 Ex	1095
<b>Explosion proof Ex e II, 3 ph., 400 Volt, 50 Hz, protection to IP 55, temp. class T1-T3</b>																
1350	1070	120*	0.37*		470	40	—	12	HQD 250/4 Ex	1144	—	—	—	—	HRFD 250/4 Ex	0470
2700	2070	250*	0.75*		470	40	—	11	HQD 250/2 Ex	1145	—	—	—	—	HRFD 250/2 Ex	0471

\* values, Ex see info page 16.

<sup>1)</sup> Special design not possible. <sup>2)</sup> Type HRFW: connect using wiring diagram no. SS-962. <sup>3)</sup> Type HRFW./2: connect using wiring diagram no. SS-963.





### 250/2

Frequency	Hz	Total	125	250	500	1k	2k	4k	8k	
LWA	Air noise	dB(A)	75	38	53	66	68	70	69	62
LPA <sub>4m</sub>	Air noise	dB(A)	55	18	33	46	48	49	48	42

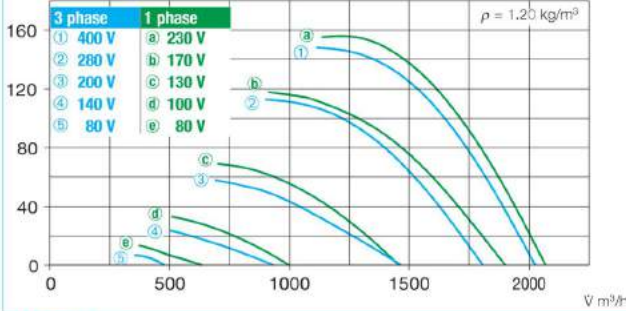

### 250/4 Three phase

Frequency	Hz	Total	125	250	500	1k	2k	4k	8k	
LWA	Air noise	dB(A)	64	50	54	61	57	55	50	41
LPA <sub>4m</sub>	Air noise	dB(A)	44	30	34	41	37	35	30	21

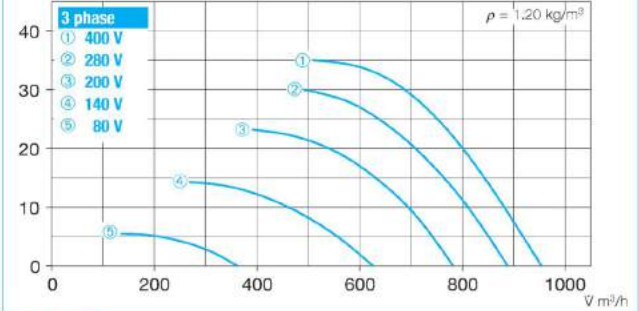

### 250/4 Single phase

Frequency	Hz	Total	125	250	500	1k	2k	4k	8k
LWA	Air noise	dB(A)	35	37	43	47	49	46	38
LPA <sub>4m</sub>	Air noise	dB(A)	35	17	23	27	29	26	18

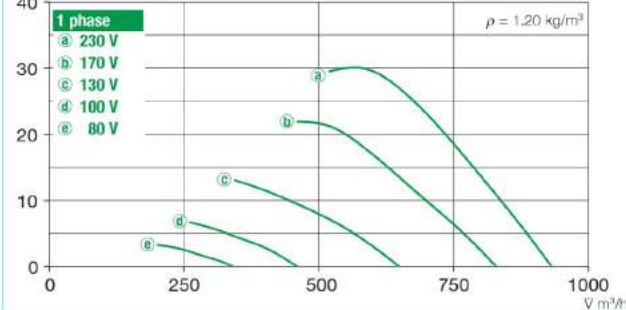

### 250/6

Frequency	Hz	Total	125	250	500	1k	2k	4k	8k
LWA	Air noise	dB(A)	33	40	47	46	43	37	30
LPA <sub>4m</sub>	Air noise	dB(A)	33	20	27	26	23	17	10

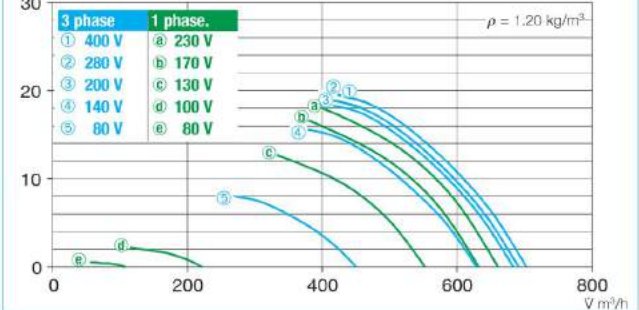

Accessories for HRF Description see page 230 on

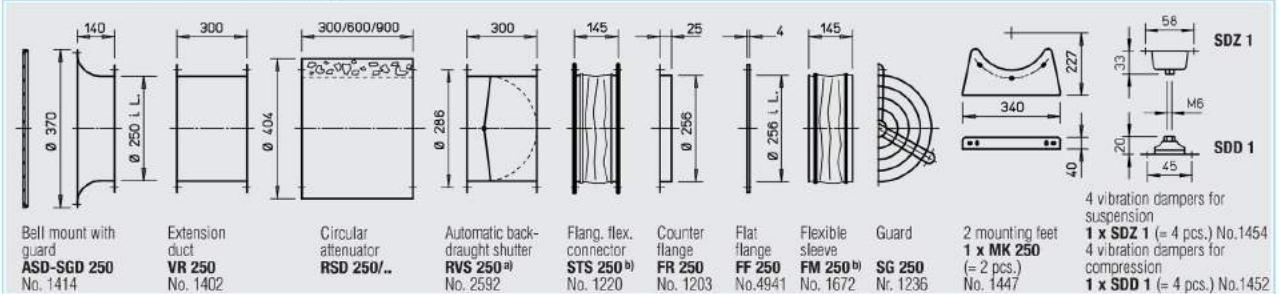

<sup>a)</sup> For motorised shutters see accessory page

<sup>b)</sup> Models for ex-proof fans see below

Frequency inverter with integrated Sine filter	Transformer controller 5-speed Pole switch	Electronic controller, stepless flush/surf.	Full motor protection for connection of integrated thermal contacts	Reversing switch					
Model	Ref. no.	Model	Ref. no.	Model	Ref. no.				
—	—	TSW 0,3	3608	ESU 1/ESA 1	0236/0238	—	—	WS	1271
—	—	TSW 0,3	3608	ESU 1/ESA 1	0236/0238	—	—	DSEL 2	1306
—	—	MWS 1,5	1947	ESU 3/ESA 3	0237/0239	MW	1579	WS	1271
FU-BS 2,5 <sup>d)</sup>	5459	RDS 1 <sup>d)</sup>	1314	—	—	MD	5849	WS	1271
FU-BS 2,5 <sup>d)</sup>	5459	RDS 1 <sup>d)</sup>	1314	—	—	MD	5849	WS	1271
FU-BS 2,5 <sup>d)</sup>	5459	RDS 1 <sup>d)</sup>	1314	—	—	MD	5849	WS	1271
—	—	Pole switch	—	—	—	—	—	—	—
—	—	PDA 12 <sup>e)</sup>	5081	—	—	M 3 <sup>e)</sup>	1293	PWDA	1282
—	—	not permitted	—	not permitted	—	—	—	—	—
—	—	not permitted	—	not permitted	—	—	—	—	—
—	—	not permitted	—	not permitted	—	—	—	—	—
—	—	not permitted	—	not permitted	—	—	—	—	—

<sup>d)</sup> Motor protection.

<sup>e)</sup> Incl. pole switch.

<sup>e)</sup> See switch product page for flush mounted version

### Other accessories Page

- Accessories for explosion proof fans
- Flanged flexible connector Type STS 250 Ex Ref. no. 2501
- Flexible sleeve Type FM 250 Ex Ref. no. 1688
- Extension tube for HS Type VH 250 Ref. no. 1343
- Cylindrical duct, galvanised steel, length: 150 mm.
- Attenuators 421 on
- Shutters and grilles 487 on
- Speed controllers and switches 525 on





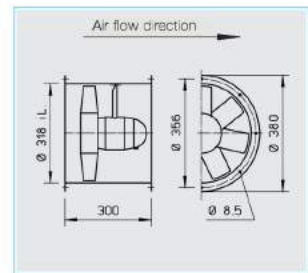
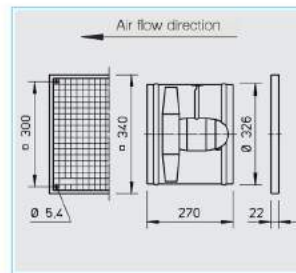
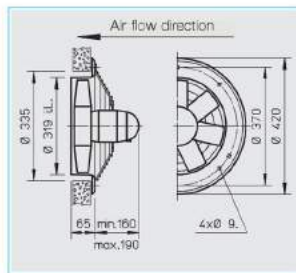
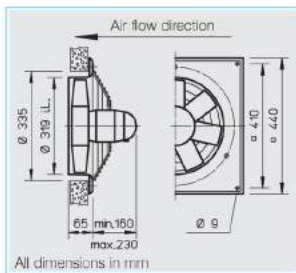

**■ Specification for all models**

**□ Casing**

Manufactured in galvanised sheet steel. Model HQ and HW have an additional two-layer finishing in papyrus white. Ex-models without paint.

**□ Impeller**

Highly efficient, profiled blade impeller, dynamically balanced and manufactured from impact resistant polymers. Suitable for -30 to +60 °C. Deviation for ex-models.

**□ Motor**

Totally enclosed motor with a die-cast aluminium casing, protected to IP 55. Ball bearing mounted. Maintenance-free and interference-free. Humidity protection of windings. For maximum air flow temp. see table below. Deviation for ex-models.

**□ Motor protection**

All models (3~ explosion proof excluded) have thermal contacts as standard which must be connected to a motor protection unit (see below). The models H..W 315/6 and all 1 ph. ex-proof fans have automatic resetting thermal contacts wired in series with the motor windings.

**□ Electrical connection**

Terminal box (IP 55) mounted on rear of motor as standard. Also on outside of piping for HRF. Deviation for ex-models.

**□ Guard**

Powder-coated steel wire for HQ and HW (HQ ex-models galvanised), polymer for HS according to DIN EN ISO 13857.

**□ Speed control**

For all speed controllable models the current are identified with a value in the "speed controlled" column of the table below which must be used when selecting a controller. Possible allocations of frequency inverters are specified in the table below. The planned use of a frequency inverter without Sine filter must be stated when ordering. This requires a change of fan design and potential additional costs. The air flow rates are shown in the performance curves.

**□ Reversed operation**

All models are reversible when wired to a reversing switch. For reverse air flow direction allow a loss in performance of approx. 1/s.

**□ Installation**

Installation in any position. Ensure that the motor drainage holes face downwards.

**□ Dimensions**

Pole-switch and explosion proof models may deviate from the information above.

**□ Sound levels**

See characteristic curve. The sound power and sound pressure are specified at 4 m distances under free field conditions, for average operating point suction/pressure side. See page 10 on for sound emission and acoustics. Deviation for ex-models.

R.P.M.	Air flow volume (FID)	Motor power	Current*		Wiring diagram	max. air flow temp.		Weight net	Model							
			standard-supply	max. controlled		standard supply	speed controlled		HQ incl. guard	Ref. no.	HW incl. guard	Ref. no.	HS incl. guard	Ref. no.	HRF	Ref. no.
min <sup>-1</sup>	∇ m <sup>3</sup> /h	W	A	A	No.	+°C	+°C	kg								
<b>1 Phase motor, 230 Volt / 50 Hz, capacitor motor, protection to IP 55</b>																
920	1330	33	0.25	0.35	317 <sup>1)</sup>	60	40	9.0	HQW 315/6	1105	—	—	HSW 315/6	0142	HRFW 315/6 <sup>1)</sup>	0202
1390	2080	104	0.45	0.47	475 <sup>2)</sup>	60	40	8.0	HQW 315/4	1106	HWW 315/4	1004	HSW 315/4	0143	HRFW 315/4 <sup>2)</sup>	0203
<b>3 Phase motor, 400 Volt / 50 Hz, squirrel cage motor protection to IP 55</b>																
950	1370	68	0.27	0.32	469	60	40	9.0	HQD 315/6	1117	—	—	—	—	—	—
1330	1960	84	0.24	0.26	469	60	40	9.0	HQD 315/4	1118	HWD 315/4	1019	HSD 315/4	0158	HRFD 315/4	0223
2760	4080	527	1.10	1.23	469	50	40	11.0	HQD 315/2	1119	HWD 315/2	1020	—	—	HRFD 315/2	0224
<b>Two-speed, 3 ph., 400 V, 50 Hz, Y/Δ switch, protection to IP 55</b>																
1040/1280	1530/1980	56/87	0.11/0.22	—	520	60	—	10.5	HQD 315/4/4	1460	—	—	—	—	HRFD 315/4/4	1462
<b>2 speed motor, pole-switching, Dahlander windings, 400 Volt, 50 Hz, protection to IP 55</b>																
720/1445	980/2050	49/115	0.20/0.43	—	472	60	—	12.0	HQD 315/8/4	1129	—	—	HSD 315/8/4	0346	HRFD 315/8/4	0391
1445/2845	2100/4190	106/558	0.45/1.32	—	472	50	—	12.5	HQD 315/4/2	1131	—	—	HSD 315/4/2	0348	HRFD 315/4/2	0393
<b>Explosion proof Ex d II B, 1 ph., 230 Volt, 50 Hz, protection to IP 55, temp. class T1-T3</b>																
1370	2070	180*	1.25*	—	757	40	—	13.0	HQW 315/4 Ex	0442	—	—	—	—	HRFW 315/4 Ex	0439
<b>Explosion proof Ex e II, 3 ph., 400 Volt, 50 Hz, protection to IP 55, temp. class T1-T3</b>																
920	1400	250*	0.97*	—	470	40	—	23.0	HQD 315/6 Ex	1098	—	—	—	—	—	—
1350	2140	120*	0.37*	—	470	40	—	14.0	HQD 315/4 Ex	1147	—	—	—	—	HRFD 315/4 Ex	0473
1790	4130	550*	1.43*	—	470	40	—	16.5	HQD 315/2 Ex	1148	—	—	—	—	HRFD 315/2 Ex	0474

\* values, Ex see info page 16.

<sup>1)</sup> Type HRFW./6: connect using wiring diagram no. SS-963.

<sup>2)</sup> Type HRFW./4: connect using wiring diagram no. SS-965.

<sup>3)</sup> Incl. full motor protection.





### 315/2

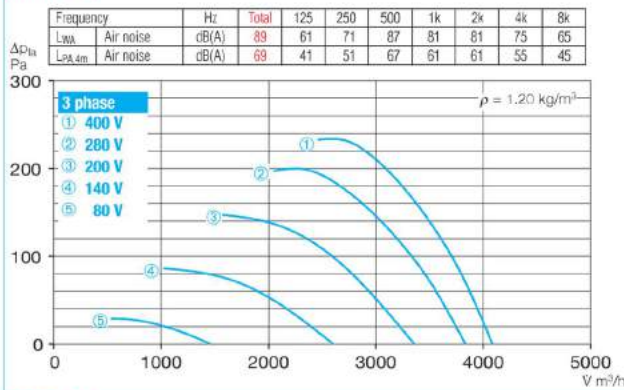

### 315/4

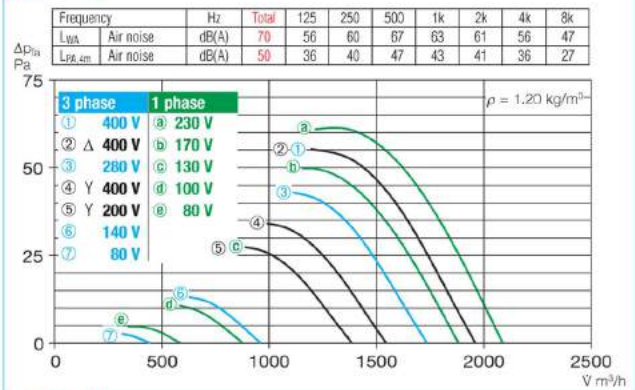

### 315/6

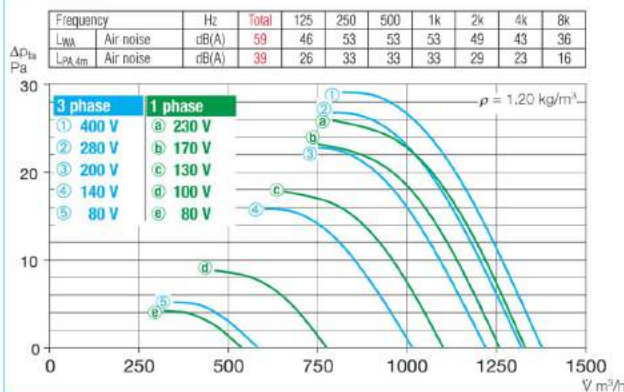

### 315/8

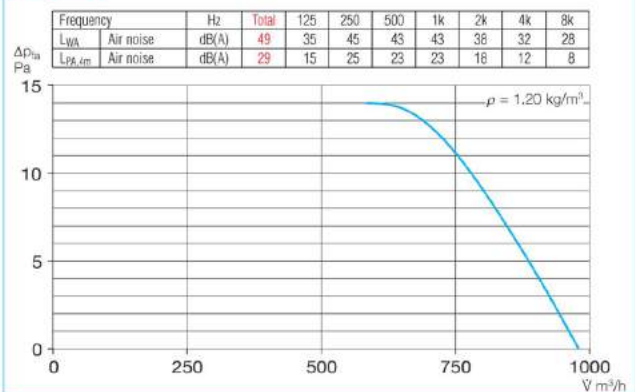

Accessories for HRF Description see page 230 on

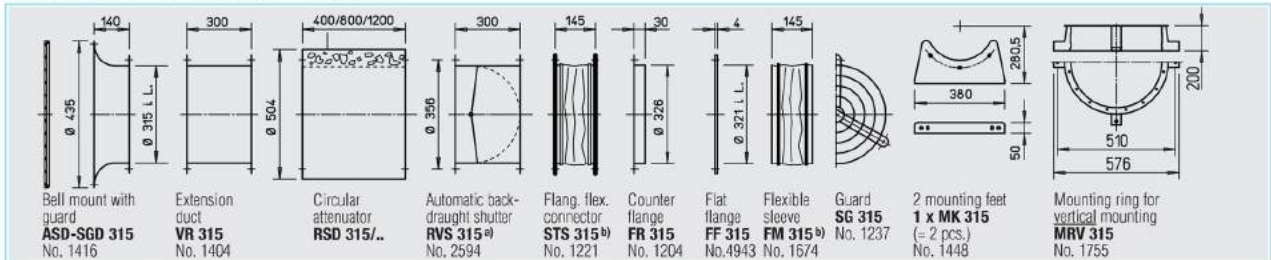

<sup>a)</sup> For motorised shutters see accessory page

<sup>b)</sup> Models for ex-proof fans see below

Frequency inverter with integrated Sine filter	Transformer controller 5-speed Pole switch	Electronic controller, stepless flush/surt.	Full motor protection for connection of integrated thermal contacts	Reversing switch					
Model	Ref. no.	Model	Ref. no.	Model	Ref. no.	Model	Ref. no.		
—	—	TSW 0,3	3608	ESU 1/ESA 1	0236/0238	—	—	WS	1271
—	—	MWS 1,5 <sup>3)</sup>	1947	ESU 1/ESA 1	0236/0238	MW	1579	WS	1271
FU-BS 2,5 <sup>3)</sup>	5459	RDS 1 <sup>3)</sup>	1314	—	—	MD	5849	WS	1271
FU-BS 2,5 <sup>3)</sup>	5459	RDS 1 <sup>3)</sup>	1314	—	—	MD	5849	WS	1271
FU-BS 2,5 <sup>3)</sup>	5459	RDS 2 <sup>3)</sup>	1315	ESD 5	0501	MD	5849	WS	1271
Speed switch									
FU-BS 2,5 <sup>3)</sup>	5459	DS2	1351	—	—	M 4 <sup>4)</sup> /MD	1571/5849	WS	1271
Pole switch									
—	—	PDA 12 <sup>5)</sup>	5081	—	—	M 3 <sup>4)</sup>	1293	PWDA	1282
—	—	PDA 12 <sup>5)</sup>	5081	—	—	M 3 <sup>4)</sup>	1293	PWDA	1282
—	—	not permitted	not permitted	—	—	—	—	—	—
—	—	not permitted	not permitted	—	—	—	—	—	—
—	—	not permitted	not permitted	—	—	—	—	—	—
—	—	not permitted	not permitted	—	—	—	—	—	—

<sup>5)</sup> See switch product page for flush mounted version.

### Other accessories Page

<sup>b)</sup> Accessories for explosion proof fans	
Flanged flexible connector	Type STS 315 Ex Ref. no. 2503
Flexible sleeve	Type FM 315 Ex Ref. no. 1690
Extension tube for HS	
Type VH 315	Ref. no. 1344
Cylindrical duct, galvanised steel, length: 150 mm.	
Attenuators	421 on
Shutters and grilles	487 on
Speed controllers and switches	525 on





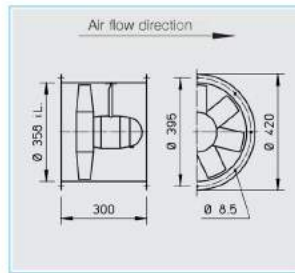
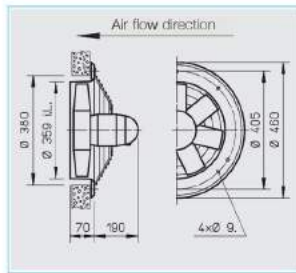
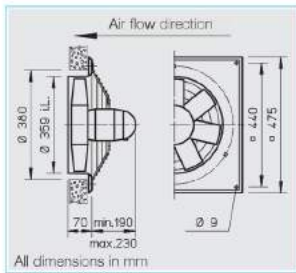

**■ Specification for all models**

**□ Casing**

Manufactured in galvanised sheet steel. Model HQ and HW have an additional two-layer finishing in papyrus white. Ex-models without paint.

**□ Impeller**

Highly efficient, profiled blade impeller, dynamically balanced and manufactured from impact resistant polymers. Suitable for -30 to +60 °C. Deviation for ex-models.

**□ Motor**

Totally enclosed motor with a die-cast aluminium casing, protected to IP 55. Ball bearing mounted. Maintenance-free and interference-free. Humidity protection of windings. For maximum air flow temp. see table below. Deviation for ex-models.

**□ Motor protection**

All models (3~ explosion proof excluded) have thermal contacts as standard which must be connected to a motor protection unit (see below). 1 ph. ex-proof fans have automatic resetting thermal contacts wired in series with the motor windings.

**□ Electrical connection**

Terminal box (IP 55) mounted on rear of motor as standard. Also on outside of piping for HRF. Deviation for ex-models.

**□ Guard**

Powder-coated steel wire for HQ and HW (HQ ex-models galvanised) according to DIN EN ISO 13857.

**□ Speed control**

For all speed controllable models the current are identified with a value in the "speed controlled" column of the table below which must be used when selecting a controller. Possible allocations of frequency inverters are specified in the table below. The planned use of a frequency inverter without Sine filter must be stated when ordering. This requires a change of fan design and potential additional costs. The air flow rates are shown in the performance curves.

**□ Reversed operation**

All models are reversible when wired to a reversing switch. For reverse air flow direction allow a loss in performance of approx. 1/3.

**□ Installation**

Installation in any position. Ensure that the motor drainage holes face downwards.

**□ Dimensions**

Pole-switch and explosion proof models may deviate from the information above.

**□ Sound levels**

See characteristic curve. The sound power and sound pressure are specified at 4 m distances under free field conditions, for average operating point suction/pressure side. See page 10 on for sound emission and acoustics. Deviation for ex-models.

R.P.M.	Air flow volume (FID)	Motor power	Current*		Wiring diagram	max. air flow temp. standard supply	max. speed controlled	Weight net	Model					
			standard-supply	max. controlled					HQ incl. guard	Ref. no.	HW incl. guard	Ref. no.	HRF	Ref. no.
min <sup>-1</sup>	∇ m <sup>3</sup> /h	W	A	A	No.	+°C	+°C	kg						
<b>1 Phase motor, 230 Volt / 50 Hz, capacitor motor, protection to IP 55</b>														
960	1940	75	0.47	0.47	475 <sup>1)</sup>	60	40	12	HQW 355/6	1107	—	—	HRFW 355/6 <sup>1)</sup>	0204
1345	2850	130	0.60	0.65	475 <sup>1)</sup>	60	40	11	HQW 355/4	1108	HWW 355/4	1006	HRFW 355/4 <sup>1)</sup>	0205
<b>3 Phase motor, 400 Volt / 50 Hz, squirrel cage motor protection to IP 55</b>														
960	1970	70	0.27	0.29	469	60	40	9.5	HQD 355/6	1120	—	—	—	—
1375	2900	130	0.35	0.35	469	60	40	11.0	HQD 355/4	1121	HWD 355/4	1022	HRFD 355/4	0226
2670	5710	825	1.60	1.60	469	60	40	15.0	HQD 355/2	1122	HWD 355/2	1023	HRFD 355/2	0227
<b>Two-speed, 3 ph., 400 V, 50 Hz, Y/Δ switch, protection to IP 55</b>														
1120/1350	2460/2860	90/132	0.17/0.32		520	60	—	11.0	HQD 355/4/4	1463	—	—	HRFD 355/4/4	1464
<b>2 speed motor, pole-switching, Dahlander windings, 400 Volt, 50 Hz, protection to IP 55</b>														
700/1395	1430/2920	45/145	0.14/0.35		472	60	—	11.0	HQD 355/8/4	1132	—	—	HRFD 355/8/4	0394
1430/2840	3050/6150	250/950*	0.63/2.30*		472	40	—	16.0	HQD 355/4/2	1134	—	—	HRFD 355/4/2	0396
<b>Explosion proof Ex d II B, 1 ph., 230 Volt, 50 Hz, protection to IP 55, temp. class T1-T3</b>														
1370	2940	180*	1.25*		757	40	—	18.0	HQW 355/4 Ex	0444	—	—	HRFW 355/4 Ex	0443
<b>Explosion proof Ex e II, 3 ph., 400 Volt, 50 Hz, protection to IP 55, temp. class T1-T3</b>														
920	2010	250*	0.97*		470	40	—	25.0	HQD 355/6 Ex	1101	—	—	—	—
1350	3060	120*	0.37*		470	40	—	18.0	HQD 355/4 Ex	1150	—	—	HRFD 355/4 Ex	0476
2670	5910	1100*	2.60*		470	40	—	12.5	HQD 355/2 Ex	1261	—	—	HRFD 355/2 Ex	0136

\* Values, Ex see info page 16.

<sup>1)</sup> Type HRFW: connect using wiring diagram no. SS-965.

<sup>2)</sup> Incl. full motor protection.

<sup>3)</sup> Incl. pole switch.



### 355/2

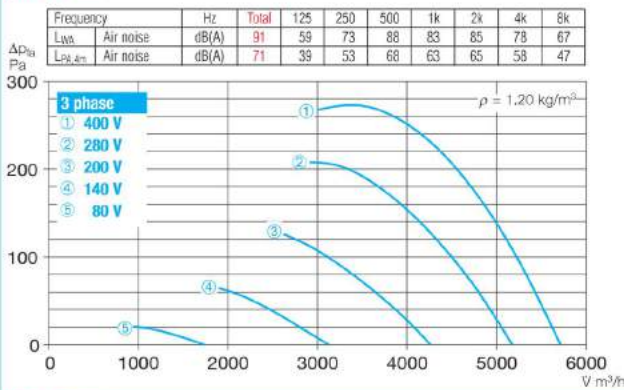

### 355/4

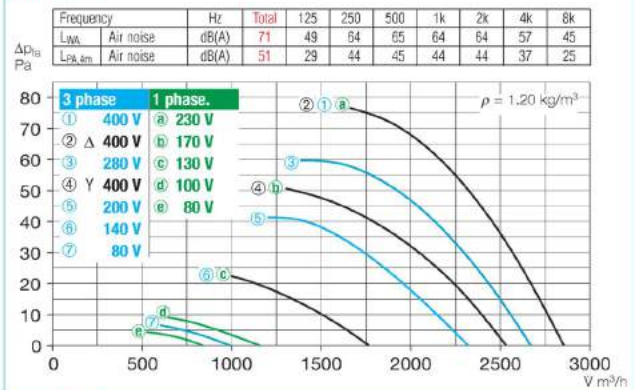

### 355/6

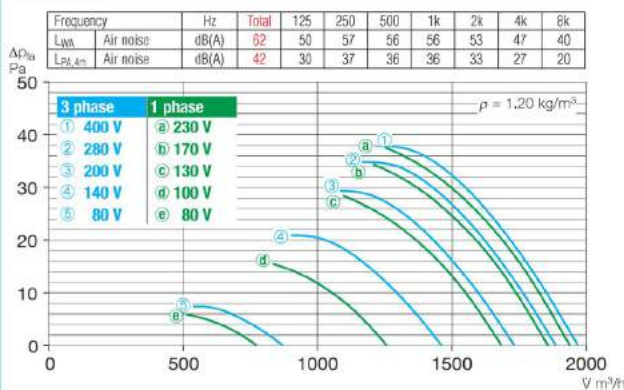

### 355/8

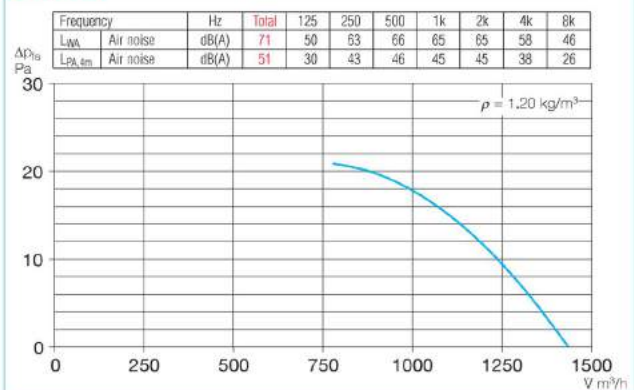

Accessories for HRF Description see page 230 on

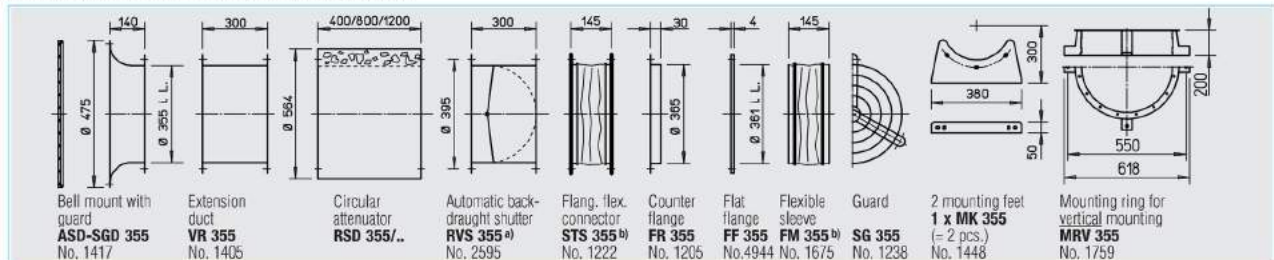

<sup>a)</sup> For motorised shutters see accessory page

<sup>b)</sup> Models for ex-proof fans see below

Frequency inverter with integrated Sine filter	Transformer controller 5-speed Pole switch	Electronic controller, stepless flush/surf.	Full motor protection for connection of integrated thermal contacts	Reversing switch
Model	Model	Model	Model	Model
Ref. no.	Ref. no.	Ref. no.	Ref. no.	Ref. no.
—	MWS 1,5 <sup>2)</sup>	ESU 1/ESA 1	MW	WS
—	1947	0236/0238	1579	1271
—	MWS 1,5 <sup>2)</sup>	ESU 1/ESA 1	MW	WS
—	1947	0236/0238	1579	1271
FU-BS 2,5 <sup>2)</sup>	RDS 1 <sup>2)</sup>	—	MD	WS
5459	1314	—	5849	1271
FU-BS 2,5 <sup>2)</sup>	RDS 1 <sup>2)</sup>	—	MD	WS
5459	1314	—	5849	1271
FU-BS 2,5 <sup>2)</sup>	RDS 2 <sup>2)</sup>	ESD 5	MD	WS
5459	1315	0501	5849	1271
Speed switch				
—	DS 2	—	M 4 <sup>3)</sup> /MD	WS
—	1351	—	1571/5849	1271
Pole switch				
—	PDA 12 <sup>4)</sup>	—	M 3 <sup>3)</sup>	PWDA
—	5081	—	1293	1282
—	PDA 12 <sup>4)</sup>	—	MSA	PWDA
—	5081	—	1289	1282
—	not permitted	not permitted	—	—
—	not permitted	not permitted	—	—
—	not permitted	not permitted	—	—
—	not permitted	not permitted	—	—

### Other accessories Page

- Accessories for explosion proof fans
- Flanged flexible connector Type STS 355 Ex Ref. no. 2504
- Flexible sleeve Type FM 355 Ex Ref. no. 1691
- Extension tube for HS Type VH 355 Ref. no. 1345
- Cylindrical duct, galvanised steel, length: 150 mm.
- Attenuators 421 on
- Shutters and grilles 487 on
- Speed controllers and switches 525 on



product page for flush mounted version.



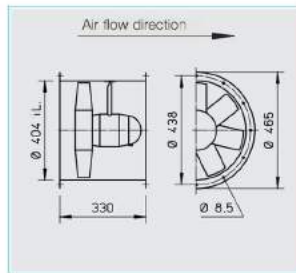
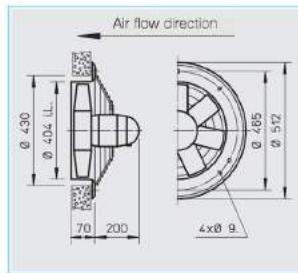
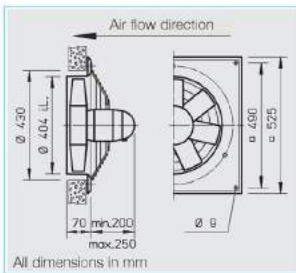

**■ Specification for all models**

**□ Casing**

Manufactured in galvanised sheet steel. Model HQ and HW have an additional two-layer finishing in papyrus white. Ex-models without paint.

**□ Impeller**

Highly efficient, profiled blade impeller, dynamically balanced and manufactured from impact resistant polymers. Suitable for -30 to +60 °C. Deviation for ex-models.

**□ Motor**

Totally enclosed motor with a die-cast aluminium casing, protected to IP 55. Ball bearing mounted. Maintenance-free and interference-free. Humidity protection of windings. For maximum air flow temp. see table below. Deviation for ex-models.

**□ Motor protection**

All models (explosion proof excluded) have thermal contacts as standard which must be connected to a motor protection unit (see below).

**□ Electrical connection**

Terminal box (IP 55) mounted on rear of motor as standard. Also on outside of piping for HRF. Deviation for ex-models.

**□ Guard**

Powder-coated steel wire for HQ and HW (HQ ex-models galvanised) according to DIN EN ISO 13857

**□ Speed control**

For all speed controllable models the current are identified with a value in the "speed controlled" column of the table below which must be used when selecting a controller. Possible allocations of frequency inverters are specified in the table below. The planned

use of a frequency inverter without Sine filter must be stated when ordering. This requires a change of fan design and potential additional costs. The air flow rates are shown in the performance curves.

**□ Reversed operation**

All models are reversible when wired to a reversing switch. For reverse air flow direction allow a loss in performance of approx. 1/3.

**□ Installation**

Installation in any position. Ensure that the motor drainage holes face downwards.

**□ Dimensions**

Pole-switch and explosion proof models may deviate from the information above.

**□ Sound levels**

See characteristic curve. The sound power and sound pressure are specified at 4 m distances under free field conditions, for average operating point suction/pressure side. See page 10 on for sound emission and acoustics. Deviation for ex-models.

Information	Page
Techn. description	140
Selection chart	141
Information for planning	10 on
<b>Made to order designs</b>	
Alternative voltages, protection classes, air flow direction, air flow temperature, acid protection and cast aluminium impellers are available on request.	
Note the technical information on page 15 on.	

R.P.M.	Air flow volume (FID)	Motor power	Current*		Wiring diagram	max. air flow temp. standard supply	speed controlled	Weight net	Model					
			standard-supply	max. controlled					HQ incl. guard	Ref. no.	HW incl. guard	Ref. no.	HRF	Ref. no.
min <sup>-1</sup>	∇ m <sup>3</sup> /h	W	A	A	No.	+°C	+°C	kg						
<b>1 Phase motor, 230 Volt / 50 Hz, capacitor motor, protection to IP 55</b>														
930	2570	77	0.52	0.54	475 <sup>1)</sup>	60	40	13.0	HQW 400/6	1110	—	—	HRFW 400/6 <sup>1)</sup>	0206
1350	4010	235	1.00	1.10	475 <sup>1)</sup>	60	40	14.0	HQW 400/4	1111	HW 400/4	1008	HRFW 400/4 <sup>1)</sup>	0207
<b>3 Phase motor, 400 Volt / 50 Hz, squirrel cage motor protection to IP 55</b>														
950	2620	89	0.28	0.30	469	60	40	13.0	HQD 400/6	1123	—	—	—	—
1330	3960	200	0.40	0.40	469	60	40	14.0	HQD 400/4	1124	HWD 400/4	1025	HRFD 400/4	0229
<b>Two-speed, 3 ph., 400 V, 50 Hz, Y/Δ switch, protection to IP 55</b>														
1325/1085	3170/3920	135/205	0.25/0.45	0.45	520	60	40	20.0	HQD 400/4/4	1465	—	—	HRFD 400/4/4	1466
2890/2600	7890/8400	1300/2310*	3.00/5.60*	4.70	520	40	40	25.0	HQD 400/2/2	1475	—	—	HRFD 400/2/2	1474
<b>2 speed motor, pole-switching, Dahlander windings, 400 Volt, 50 Hz, protection to IP 55</b>														
690/1390	2010/4100	70/250	0.25/0.60	—	472	60	—	13.0	HQD 400/8/4	1137	—	—	HRFD 400/8/4	0399
1480/2940	4180/8540	300/2310*	1.00/5.20*	—	472	40	—	24.0	HQD 400/4/2	1139	—	—	HRFD 400/4/2	0401
<b>Explosion proof Ex e II, 3 ph., 400 Volt, 50 Hz, protection to IP 55, temp. class T1-T3</b>														
920	2870	250*	0.97*	—	470	40	—	13.0	HQD 400/6 Ex	1109	—	—	—	—
1370	4380	370*	1.08*	—	470	40	—	16.0	HQD 400/4 Ex	1153	—	—	HRFD 400/4 Ex	0479

\* Motor nominal values, Ex see info page 16.

<sup>1)</sup> Type HRFW: connect using wiring diagram no. SS-965.

<sup>2)</sup> Incl. full motor protection.

<sup>3)</sup> Incl. pole switch.



### 400/2

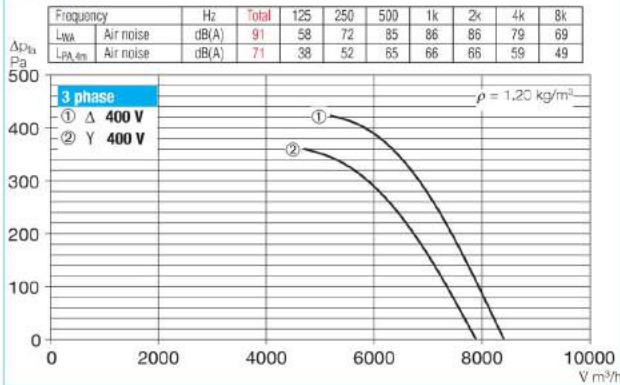

### 400/4

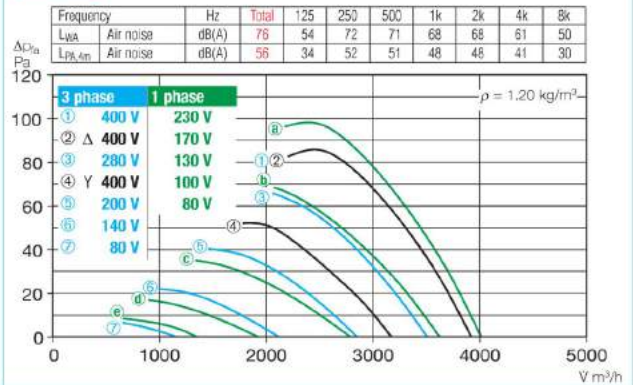

### 400/6

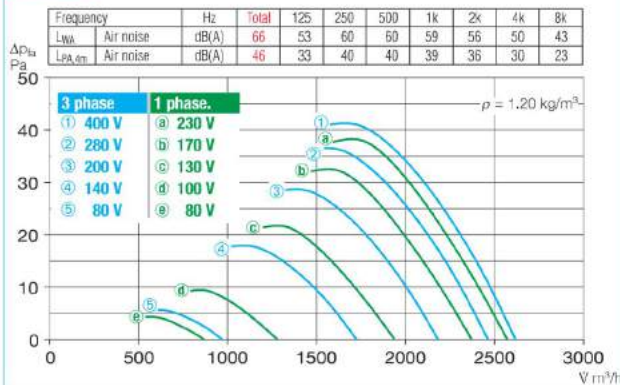

### 400/8

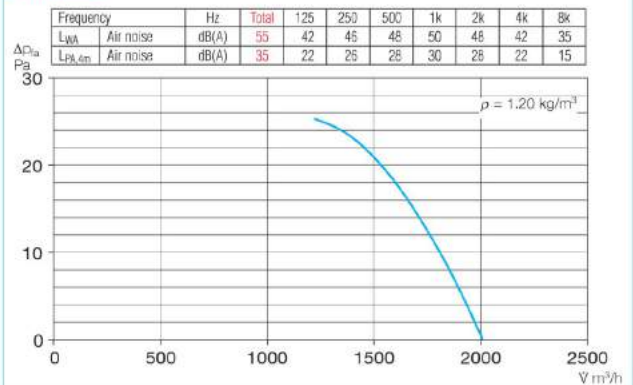

Accessories for HRF Description see page 230 on

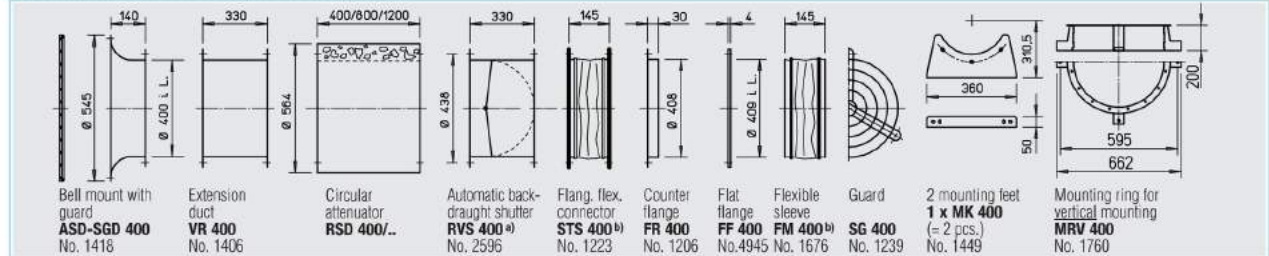

<sup>a)</sup> For motorised shutters see accessory page

<sup>b)</sup> Models for ex-proof fans see below

Frequency inverter with integrated Sine filter		Transformer controller 5-speed Pole switch		Electronic controller, stepless flush/surf.		Full motor protection for connection of integrated thermal contacts		Reversing switch	
Model	Ref. no.	Model	Ref. no.	Model	Ref. no.	Model	Ref. no.	Model	Ref. no.
—	—	MWS 1,5 <sup>2)</sup>	1947	ESU 1/ESA 1	0236/0238	MW	1579	WS	1271
—	—	MWS 1,5 <sup>2)</sup>	1947	ESU 3/ESA 3	0237/0239	MW	1579	WS	1271
FU-BS 2,5 <sup>2)</sup>	5459	RDS 1 <sup>2)</sup>	1314	—	—	MD	5849	WS	1271
FU-BS 2,5 <sup>2)</sup>	5459	RDS 1 <sup>2)</sup>	1314	—	—	MD	5849	WS	1271
Speed switch									
FU-BS 2,5 <sup>2)</sup>	5459	RDS 1 <sup>2)</sup>	1314	—	—	M 4 <sup>4)</sup> /MD	1571/5849	WS	1271
FU-BS 5 <sup>2)</sup>	5460	DS 2	1351	ESD 5 <sup>2)</sup>	0501	M 4 <sup>4)</sup> /MD	1571/5849	WS	1271
Pole switch									
—	—	PDA 12 <sup>4)</sup>	5081	—	—	M 3 <sup>3)</sup>	1293	PWDA	1282
—	—	PDA 12 <sup>4)</sup>	5081	—	—	M 3 <sup>3)</sup>	1293	PWDA	1282
—	—	not permitted	not permitted	not permitted	not permitted	—	—	—	—
—	—	not permitted	not permitted	not permitted	not permitted	—	—	—	—

<sup>3)</sup> Speed switch product page for flush mounted version.

### Other accessories Page

<sup>b)</sup> Accessories for explosion proof fans	
Flanged flexible connector Type STS 400 Ex	Ref. no. 2505
Flexible sleeve Type FM 400 Ex	Ref. no. 1692
Extension tube for HS Type VH 400	Ref. no. 1346
Cylindrical duct, galvanised steel, length: 150 mm.	
Attenuators	421 on
Shutters and grilles	487 on
Speed controllers and switches	525 on





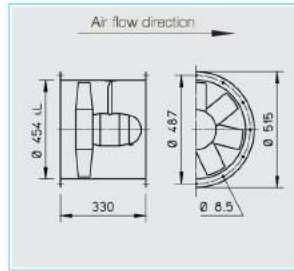
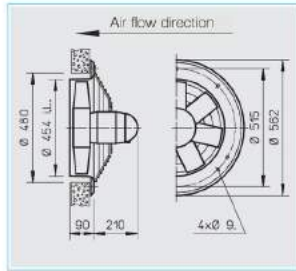
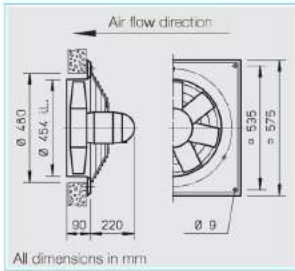

All dimensions in mm.

**■ Specification for all models**

**□ Casing**

Manufactured in galvanised sheet steel. Model HQ and HW have an additional two-layer finishing in papyrus white. Ex-models without paint.

**□ Impeller**

Highly efficient, profiled blade impeller, dynamically balanced and manufactured from impact resistant polymers. Suitable for -30 to +60 °C. Deviation for ex-models.

**□ Motor**

Totally enclosed motor with a die-cast aluminium casing, protected to IP 55. Ball bearing mounted. Maintenance-free and interference-free. Humidity protection of windings. For maximum air flow temp. see table below. Deviation for ex-models.

**□ Motor protection**

All models (explosion proof excluded) have thermal contacts as standard which must be connected to a motor protection unit (see below).

**□ Electrical connection**

Terminal box (IP 55) mounted on rear of motor as standard. Also on outside of piping for HRF. Deviation for ex-models.

**□ Guard**

Powder-coated steel wire for HQ and HW (HQ ex-models galvanised) according to DIN EN ISO 13857.

**□ Speed control**

For all speed controllable models the current are identified with a value in the "speed controlled" column of the table below which must be used when selecting a controller. Possible allocations of frequency inverters are specified in the table below. The planned use of a frequency inverter without Sine filter must be stated when ordering. This requires a change of fan design and potential additional costs. The air flow rates are shown in the performance curves.

**□ Reversed operation**

All models are reversible when wired to a reversing switch. For reverse air flow direction allow a loss in performance of approx. 1/3.

**□ Installation**

Installation in any position. Ensure that the motor drainage holes face downwards.

**□ Dimensions**

Pole-switch and explosion proof models may deviate from the information above.

**□ Sound levels**

See characteristic curve. The sound power and sound pressure are specified at 4 m distances under free field conditions, for average operating point suction/pressure side. See page 10 on for sound emission and acoustics. Deviation for ex-models.

R.P.M.	Air flow volume (FID)	Motor power	Current*		Wiring diagram	max. air flow temp. standard supply	speed controlled	Weight net	Model						
			standard-supply	max. controlled					Ref. no.	HQ incl. guard	Ref. no.	HW incl. guard	Ref. no.	HRF	Ref. no.
min <sup>-1</sup>	∇ m <sup>3</sup> /h	W	A	A	No.	+°C	+°C	kg							
<b>1 Phase motor, 230 Volt / 50 Hz, capacitor motor, protection to IP 55</b>															
915	3890	136	0.63	0.63	475 <sup>1)</sup>	60	40	19.0	HQW 450/6	0991	—	—	HRFW 450/6 <sup>1)</sup>	0208	
1380	5770	405	1.76	2.02	475 <sup>1)</sup>	60	40	18.0	HQW 450/4	0992	HWW 450/4	1010	HRFW 450/4 <sup>1)</sup>	0209	
<b>3 Phase motor, 400 Volt / 50 Hz, squirrel cage motor protection to IP 55</b>															
960	3920	137	0.38	0.42	469	60	40	18.0	HQD 450/6	0993	—	—	HRFD 450/6	0230	
1390	5810	384	0.81	0.92	469	50	40	17.0	HQD 450/4	0994	HWD 450/4	1028	HRFD 450/4	0231	
<b>Two-speed, 3 ph., 400 V, 50 Hz, Y/Δ switch, protection to IP 55</b>															
1130/1390	5090/5780	280/378	0.51/0.82	—	520	60	—	22.0	HQD 450/4/4	1467	—	—	HRFD 450/4/4	1468	
2775/2200	10190/9335	1300/2310*	5.40/3.0*	5.10	520	40	40	32.0	—	—	—	—	HRFD 450/2/2	0484	
<b>2 speed motor, pole-switching, Dahlander windings, 400 Volt, 50 Hz, protection to IP 55</b>															
480/970	1930/3950	62/163	0.22/0.47	—	472	60	—	18.0	HQD 450/12/6	0995	—	—	—	—	
705/1410	2860/5810	91/404	0.36/0.92	—	472	50	—	20.0	HQD 450/8/4	0996	—	—	HRFD 450/8/4	0403	
<b>Explosion proof Ex e II, 3 ph., 400 Volt, 50 Hz, protection to IP 55, temp. class T1-T3</b>															
920	4090	250*	0.97*	—	470	40	—	15.5	HQD 450/6 Ex	1473	—	—	—	—	
1370	6240	370*	1.08*	—	470	40	—	15.5	HQD 450/4 Ex	1154	—	—	HRFD 450/4 Ex	0481	

\* nominal values, Ex see info page 16.

<sup>1)</sup> Type HRFW: connect using wiring diagram no. SS-965.

<sup>2)</sup> Incl. full motor protection.

<sup>3)</sup> see switch product page for flush mounted version.



### 450/2

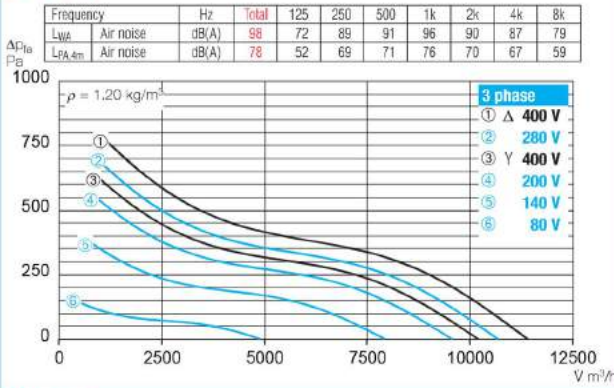

### 450/4

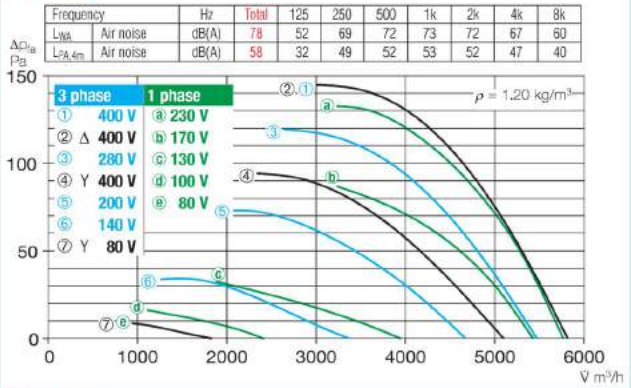

### 450/6

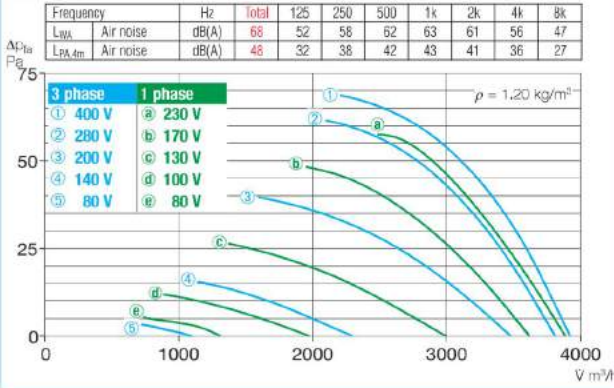

### 450/8

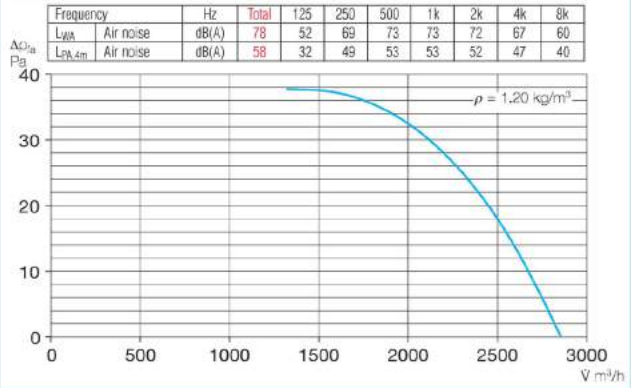

Accessories for HRF Description see page 230 on

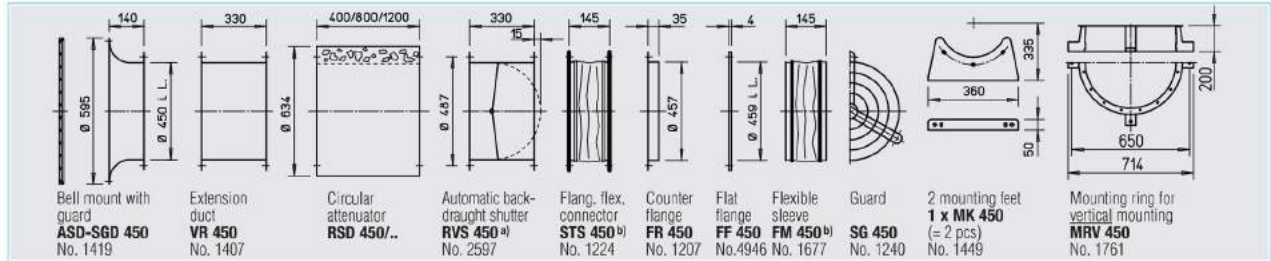

<sup>a)</sup> For motorised shutters see accessory page

<sup>b)</sup> Models for ex-proof fans see below

Frequency inverter with integrated Sine filter		Transformer controller 5-speed Pole switch		Electronic controller, stepless flush/surf.		Full motor protection for connection of integrated thermal contacts		Reversing switch	
Model	Ref. no.	Model	Ref. no.	Model	Ref. no.	Model	Ref. no.	Model	Ref. no.
—	—	MWS 1,5 <sup>2)</sup>	1947	ESU 3/ESA 3	0237/0239	MW	1579	WS	1271
—	—	MWS 3 <sup>2)</sup>	1948	ESU 3/ESA 3	0237/0239	MW	1579	WS	1271
FU-BS 2,5 <sup>2)</sup>	5459	RDS 1 <sup>2)</sup>	1314	—	—	MD	5849	WS	1271
FU-BS 2,5 <sup>2)</sup>	5459	RDS 2 <sup>2)</sup>	1315	ESD 5 <sup>2)</sup>	0501	MD	5849	WS	1271
Speed switch									
FU-BS 2,5 <sup>2)</sup>	5459	DS 2 <sup>2)</sup>	1351	—	—	M 4 <sup>4)</sup> /MD	1571/5849	WS	1271
FU-BS 8,0 <sup>2)</sup>	5461	RDS 7 <sup>2)</sup>	1578	ESD 11,5 <sup>2)</sup>	0502	M 4 <sup>4)</sup> /MD	1571/5849	WS	1271
Pole switch									
—	—	PDA 12 <sup>3)</sup>	5081	—	—	M 3 <sup>4)</sup>	1293	PWDA	1282
—	—	PDA 12 <sup>3)</sup>	5081	—	—	M 3 <sup>4)</sup>	1293	PWDA	1282
—	—	not permitted	not permitted	not permitted	not permitted	—	—	—	—
—	—	not permitted	not permitted	not permitted	not permitted	—	—	—	—

<sup>1)</sup> Motor speed switch.

<sup>2)</sup> Speed switch.

#### Other accessories Page

<sup>b)</sup> Accessories for explosion proof fans	
Flanged flexible connector Type STS 450 Ex	Ref. no. 2506
Flexible sleeve Type FM 450 Ex	Ref. no. 1693
Attenuators	421 on
Shutters and grilles	487 on
Speed controllers and switches	525 on





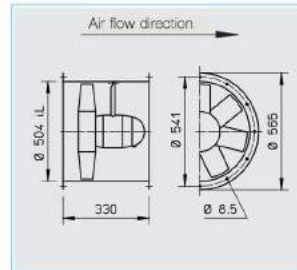
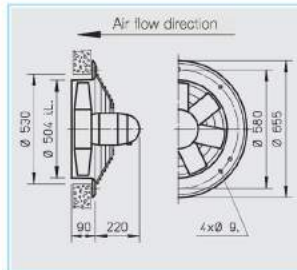
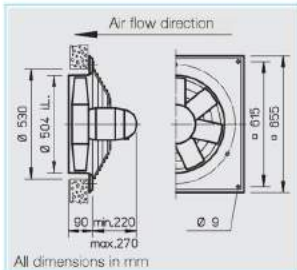

- **Specification for all models**
- **Casing**  
Manufactured in galvanised sheet steel. Model HQ and HW have an additional two-layer finishing in papyrus white. Ex-models without paint.
- **Impeller**  
Highly efficient, profiled blade impeller, dynamically balanced and manufactured from impact resistant polymers. Suitable for -30 to +60 °C. Deviation for ex-models.
- **Motor**  
Totally enclosed motor with a die-cast aluminium casing, protected to IP 55. Ball bearing mounted. Maintenance-free and interference-free. Humidity protection of windings. For maximum air flow temp. see table below. Deviation for ex-models.

- **Motor protection**  
All models (explosion proof excluded) have thermal contacts as standard which must be connected to a motor protection unit (see below).
- **Electrical connection**  
Terminal box (IP 55) mounted on rear of motor as standard. Also on outside of piping for HRF. Deviation for ex-models.
- **Guard**  
Powder-coated steel wire for HQ and HW (HQ ex-models galvanised) according to DIN EN ISO 13857.
- **Speed control**  
For all speed controllable models the current are identified with a value in the "speed controlled" column of the table below which must be used when selecting a controller. Possible allocations of

- frequency inverters are specified in the table below. The planned use of a frequency inverter without Sine filter must be stated when ordering. This requires a change of fan design and potential additional costs. The air flow rates are shown in the performance curves.
- **Reversed operation**  
All models are reversible when wired to a reversing switch. For reverse air flow direction allow a loss in performance of approx. 1/3.
- **Installation**  
Installation in any position. Ensure that the motor drainage holes face downwards.
- **Dimensions**  
Pole-switch and explosion proof models may deviate from the information above.

- **Sound levels**  
See characteristic curve. The sound power and sound pressure are specified at 4 m distances under free field conditions, for average operating point suction/pressure side. See page 10 on for sound emission and acoustics. Deviation for ex-models.

Information	Page
Techn. description	140
Selection chart	141
Information for planning	10 on

**Made to order designs**  
Alternative voltages, protection classes, air flow direction, air flow temperature, acid protection and cast aluminium impellers are available on request.

R.P.M.	Air flow volume (FID)	Motor power	Current*		Wiring diagram	max. air flow temp. speed controlled		Weight net	Model						
			standard supply	max. controlled		standard supply	speed controlled		HQ incl. guard	Ref. no.	HW incl. guard	Ref. no.	HRF	Ref. no.	
min <sup>-1</sup>	l/s	W	A	A	No.	+°C	+°C	kg							
<b>1 Phase motor, 230 Volt / 50 Hz, capacitor motor, protection to IP 55</b>															
935	5500	233	1.05	1.25	475 <sup>1)</sup>	60	40	19.0	HQW 500/6	1112	—	—	HRFW 500/6 <sup>1)</sup>	0210	
1375	8320	1100*	5.90*	4.94	475 <sup>1)</sup>	40	40	25.0	HQW 500/4	1113	—	—	HRFW 500/4 <sup>1)</sup>	0211	
<b>3 Phase motor, 400 Volt / 50 Hz, squirrel cage motor protection to IP 55</b>															
920	5480	218	0.48	0.55	469	60	40	19.0	HQD 500/6	1126	—	—	HRFD 500/6	0232	
1345	8200	620	1.22	1.32	469	40	40	19.5	HQD 500/4	1127	HWD 500/4	1030	HRFD 500/4	0233	
<b>Two-speed, 3 ph., 400 V, 50 Hz, Y/Δ switch, protection to IP 55</b>															
615/920	4330/5450	133/214	0.29/0.46	—	520	60	—	18.0	HQD 500/6/6	1471	—	—	—	—	
1030/1350	6720/8150	416/617	0.76/1.19	—	520	60	—	24.0	HQD 500/4/4	1469	—	—	HRFD 500/4/4	1470	
2450/2830	13615/12050	1960/2470*	3.14/4.73*	—	520	40	—	30.0	—	—	—	—	HRFD 500/2/2	0485	
<b>2 speed motor, pole-switching, Dahlander windings, 400 Volt, 50 Hz, protection to IP 55</b>															
465/940	2680/5490	71/248	0.23/0.56	—	472	60	—	18.0	HQD 500/12/6	1140	—	—	—	—	
700/1385	3890/8280	137/688	0.52/1.48	—	472	40	—	22.0	HQD 500/8/4	1142	—	—	HRFD 500/8/4	0407	
<b>Explosion proof Ex e II, 3 ph., 400 Volt, 50 Hz, protection to IP 55, temp. class T1-T3</b>															
920	5610	250*	0.97*	—	470	40	—	18.0	HQD 500/6 Ex	1050	—	—	HRFD 500/6 Ex	0489	
1345	8560	750*	2.00*	—	470	40	—	18.0	HQD 500/4 Ex	1157	—	—	HRFD 500/4 Ex	0483	



\* values, Ex see into page 16.

<sup>1)</sup> Type HRFW: connect using wiring diagram no. SS-965.

<sup>2)</sup> Incl. full motor protection.

<sup>3)</sup> Incl. pole switch.

### 500/2

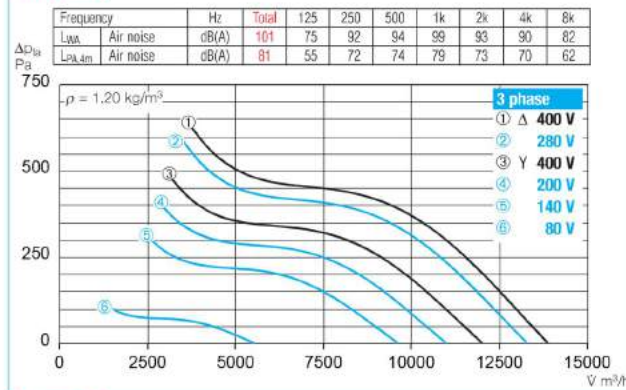

### 500/4

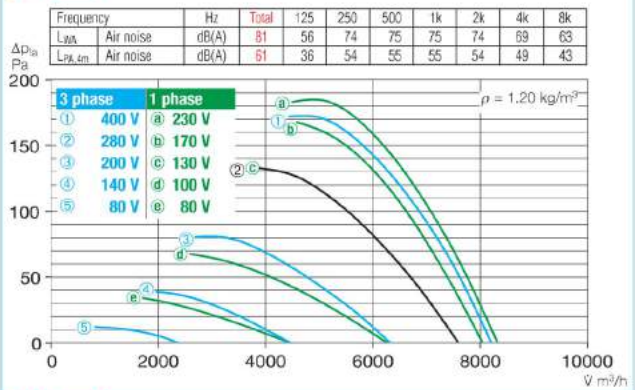

### 500/6

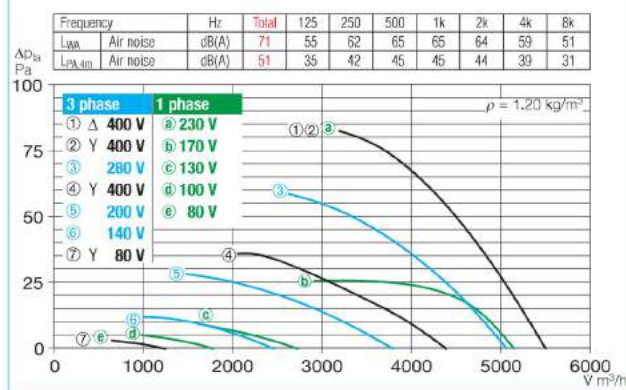

### 500/8

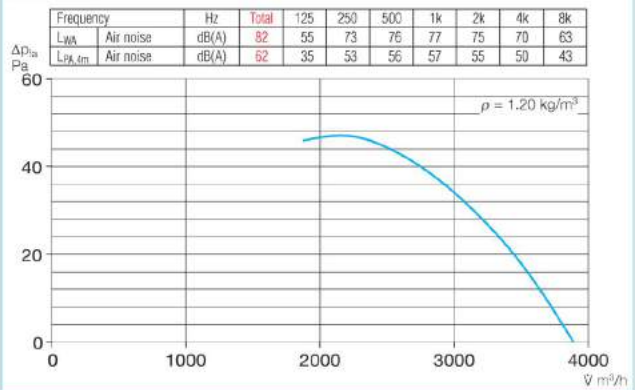

### Accessories for HRF Description see page 230 on

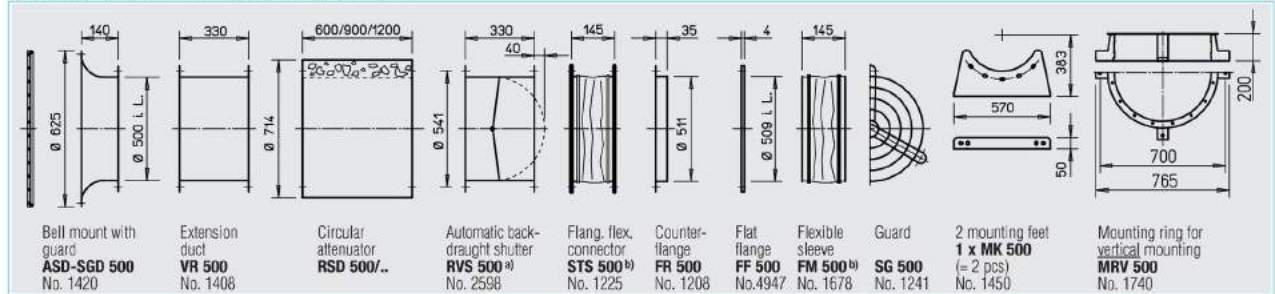

<sup>a)</sup> For motorised shutters see accessory page

<sup>b)</sup> Models for ex-proof fans see below

Frequency inverter with integrated Sine filter		Transformer controller 5-speed Pole switch		Electronic controller, stepless flush/surf.		Full motor protection for connection of integrated thermal contacts		Reversing switch	
Model	Ref. no.	Model	Ref. no.	Model	Ref. no.	Model	Ref. no.	Model	Ref. no.
—	—	MWS 1,5 <sup>2)</sup>	1947	ESU 3/ESA 3	0237/0239	MW	1579	WS	1271
—	—	MWS 5 <sup>2)</sup>	1949	ESU 5/ESA 5	1296/1299	MW	1579	WS	1271
FU-BS 2,5 <sup>2)</sup>	5459	RDS 1 <sup>2)</sup>	1314	ESD 5 <sup>2)</sup>	0501	MD	5849	WS	1271
FU-BS 2,5 <sup>2)</sup>	5459	RDS 2 <sup>2)</sup>	1315	ESD 5 <sup>2)</sup>	0501	MD	5849	WS	1271
Speed switch									
FU-BS 2,5 <sup>2)</sup>	5459	DS 2 <sup>5)</sup>	1351	—	—	M 4 <sup>4)</sup> /MD	1571/5849	WS	1271
FU-BS 2,5 <sup>2)</sup>	5459	DS 2 <sup>5)</sup>	1351	ESD 5 <sup>2)</sup>	0501	M 4 <sup>4)</sup> /MD	1571/5849	WS	1271
FU-BS 5,0 <sup>2)</sup>	5460	RDS 7 <sup>2)</sup>	1578	ESD 11,5 <sup>2)</sup>	0502	M 4 <sup>4)</sup> /MD	1571/5849	WS	1271
Pole switch									
—	—	PDA 12 <sup>4)</sup>	5081	—	—	M 3 <sup>3)</sup>	1293	PWDA	1282
—	—	PDA 12 <sup>4)</sup>	5081	—	—	M 3 <sup>3)</sup>	1293	PWDA	1282
—	—	not permitted	not permitted	not permitted	not permitted	—	—	—	—
—	—	not permitted	not permitted	not permitted	not permitted	—	—	—	—

<sup>1)</sup> product page for flush mounted version.

<sup>5)</sup> Speed switch.

### Other accessories Page

<sup>b)</sup> Accessories for explosion proof fans  
 Flanged flexible connector Type STS 500 Ex Ref. no. 2507  
 Flexible sleeve Type FM 500 Ex Ref. no. 1694

Extension tube for HS Type VH 500 Ref. no. 1348  
 Cylindrical duct, galvanised steel, length: 150 mm.

Attenuators 421 on  
 Shutters and grilles 487 on  
 Speed controllers and switches 525 on





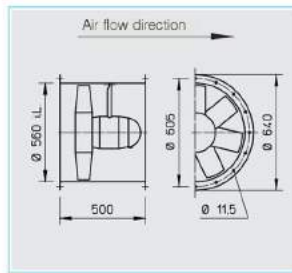
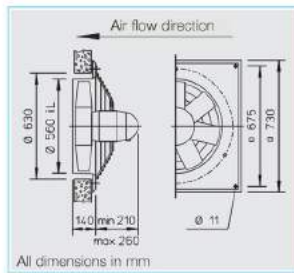

All dimensions in mm

■ **Specification for all models**

□ **Casing**

Manufactured in galvanised sheet steel. Model HQ have an additional two-layer finishing in papyrus white. Ex-models without paint.

□ **Impeller**

Highly efficient, profiled blade impeller, dynamically balanced and manufactured from impact resistant polymers. Suitable for -30 to +60 °C. Deviation for ex-models.

□ **Motor**

Totally enclosed motor with a die-cast aluminium casing, protected to IP 55. Ball bearing mounted. Maintenance-free and interference-free. Humidity protection of windings. For maximum air flow temperature see table below. Deviation for ex-models.

□ **Motor protection**

All models (except explosion proof) have thermal contacts as standard which must be connected to a motor protection unit (see below) for effective motor protection.

□ **Electrical connection**

Terminal box (IP 55) mounted on rear of motor as standard. Also on outside of piping for HRF. Deviation for ex-models.

□ **Guard**

Powder-coated steel wire for HQ (Ex-models galvanised) according to DIN EN ISO 13857.

□ **Speed control**

For all speed controllable models the current are identified with a value in the "speed controlled" column of the table below which must be used when selecting a controller. Possible allocations of frequency inverters are specified in the table below. The planned use of a frequency inverter without Sine filter must be stated when ordering. This requires a change of fan design and potential additional costs. The air flow rates are shown in the performance curves.

□ **Reversed operation**

All models are reversible when wired to a reversing switch. For reverse air flow direction allow a loss in performance of approx. 1/3.

□ **Installation**

Installation in any position. Ensure that the motor drainage holes face downwards.

□ **Dimensions**

Pole-switch and explosion proof models may deviate from the information above.

□ **Sound levels**

See characteristic curve. The sound power and sound pressure are specified at 4 m distances under free field conditions, for average operating point suction/pressure side. See page 10 on for sound emission and acoustics. Deviation for ex-models.

R.P.M.	Air flow volume (FID)	Motor power (nominal)*	Current*		Wiring diagram	max. air flow temp. standard supply	max. air flow temp. speed controlled	Weight net	Model				Transformer controller for 5 speed pole switch		Electronic controller, stepless flush/surf.		
			standard-supply	max. controlled					No.	+°C	+°C	kg	HQ incl. guard	Ref. no.	HRF	Ref. no.	Model
<b>1 Phase motor, 230 Volt / 50 Hz, capacitor motor, protection to IP 55</b>																	
935	8130	0.27	1.40	2.00	475 <sup>1)</sup>	60	40	24.0	HQW 560/6	0385	HRFW 560/6 <sup>1)</sup>	0380	MWS 3 <sup>2)</sup>	1948	ESU 3/ESA 3	0237/0239	
1370	12180	0.89	4.15	5.00	965	60	40	31.0	HQW 560/4	5054	HRFW 560/4	5055	MWS 7,5 <sup>2)</sup>	1950	ESU 5/ESA 5	1296/1299	
<b>3 Phase motor, 400 Volt / 50 Hz, squirrel cage motor protection to IP 55</b>																	
965	8180	0.28	0.79	1.00	469	60	40	26.0	HQD 560/6	0386	HRFD 560/6	0381	RDS 2 <sup>2)</sup>	1315	ESD 5 <sup>2)</sup>	0501	
1365	12250	0.88	1.71	1.80	469	40	40	29.0	HQD 560/4	0387	HRFD 560/4	0382	RDS 2 <sup>2)</sup>	1315	ESD 5 <sup>2)</sup>	0501	
<b>2 speed motor, pole-switching, Dahlander windings, 400 Volt, 50 Hz, protection to IP 55</b>																	
470/955	4000/8130	0.099/0.298	0.55/0.74	—	472	60	—	24.0	HQD 560/12/6	0389	HRFD 560/12/6	0384	PDA 12 <sup>3)</sup>	5081	—	—	
720/1365	6400/12130	0.20/0.92	0.80/1.77	—	472	40	—	26.0	HQD 560/8/4	0388	HRFD 560/8/4	0383	PDA 12 <sup>3)</sup>	5081	—	—	
<b>Explosion proof Ex e II, 3 ph., 400 Volt, 50 Hz, protection to IP 55, temp. class T1-T3</b>																	
920	8090	0.25*	0.97*	—	470	40	—	23.0	HQD 560/6 Ex	0378	HRFD 560/6 Ex	0376	not permitted	—	not permitted	—	
1390	12890	0.75*	2.00*	—	470	40	—	24.0	HQD 560/4 Ex	0379	HRFD 560/4 Ex	0377	not permitted	—	not permitted	—	

\* models: for nominal value of motor see information on page 16

<sup>1)</sup> Type HRFW: connect using wiring diagram no. SS-965

<sup>2)</sup> Incl. full motor protection

<sup>3)</sup> see switch product page for flush mounted version



### 560/4

Frequency	Hz	Total	125	250	500	1k	2k	4k	8k
L <sub>WA</sub>	Air noise	dB(A)	82	66	68	74	78	74	68
L <sub>PA,em</sub>	Air noise	dB(A)	65	46	48	54	58	54	48

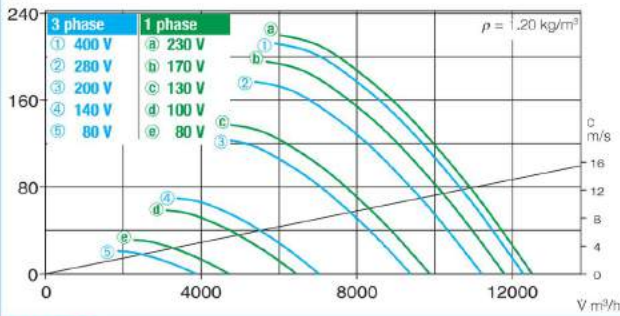

### 560/6

Frequency	Hz	Total	125	250	500	1k	2k	4k	8k
L <sub>WA</sub>	Air noise	dB(A)	72	52	59	66	68	67	63
L <sub>PA,em</sub>	Air noise	dB(A)	52	32	39	46	48	47	43

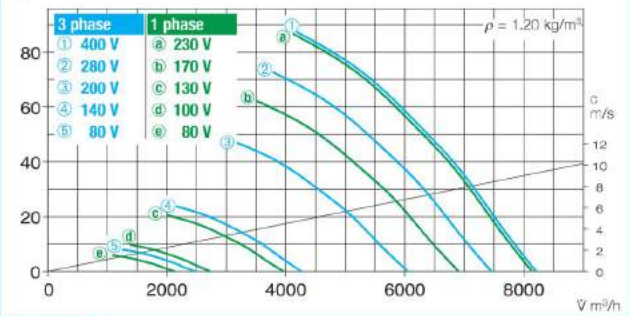

### 560/8

Frequency	Hz	Total	125	250	500	1k	2k	4k	8k
L <sub>WA</sub>	Air noise	dB(A)	65	46	48	54	58	54	48
L <sub>PA,em</sub>	Air noise	dB(A)	65	46	48	54	58	54	48

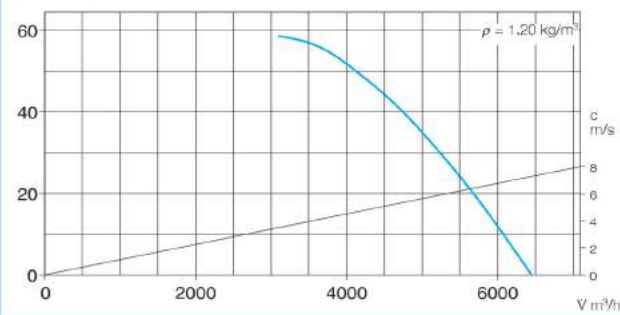

### 560/12

Frequency	Hz	Total	125	250	500	1k	2k	4k	8k
L <sub>WA</sub>	Air noise	dB(A)	52	32	39	46	48	47	43
L <sub>PA,em</sub>	Air noise	dB(A)	52	32	39	46	48	47	43

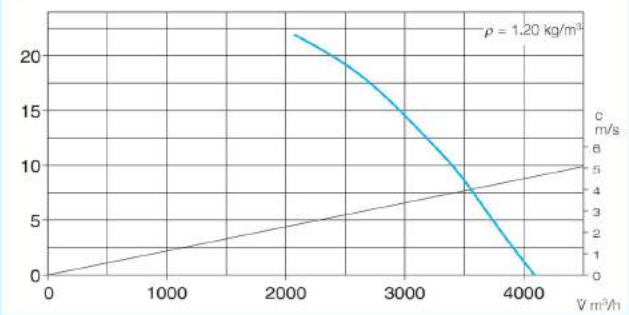

Accessories for HRF Description see page 230 on

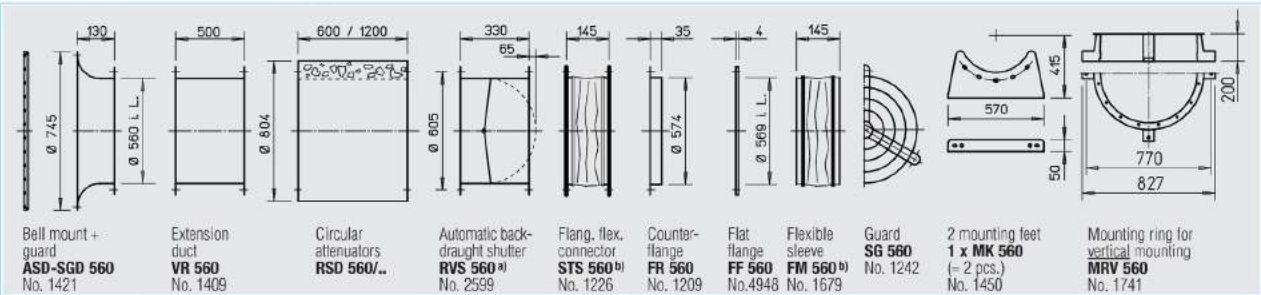

<sup>a)</sup> For motorised shutters see accessory page

<sup>b)</sup> Models for ex-proof fans see below

Electronic controller for stepless control		Full motor protection starter using the motor thermal contacts		Reversing switch	
Model	Ref. no.	Model	Ref. no.	Model	Ref. no.
—	—	MW	1579	WS	1271
—	—	MW	1579	WS	1271
FU-BS 2,5 <sup>2)</sup>	5459	MD	5849	WS	1271
FU-BS 2,5 <sup>2)</sup>	5459	MD	5849	WS	1271
—	—	M 3 <sup>4)</sup>	1293	PWDA	1282
—	—	M 3 <sup>4)</sup>	1293	PWDA	1282
—	—	—	—	—	—
—	—	—	—	—	—

1. pole switch

Information	Page	Other accessories	Page
Techn. description	140	<sup>b)</sup> Accessories for explosion proof fans	
Selection chart	141	Flanged flexible connector Type STS 560 Ex Ref. no. 2508	
Information for planning	10 on	Flexible sleeve Type FM 560 Ex Ref. no. 1695	
<b>Made to order designs</b>		Attenuators	434 on
Alternative voltages, protection classes, air flow direction, air flow temperature, acid protection and cast aluminium impellers are available on request.		Shutter and grilles	487 on
Note the technical information on page 15 on.		Speed controllers and switches	525 on





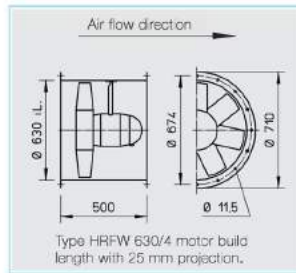
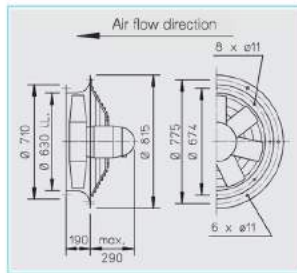
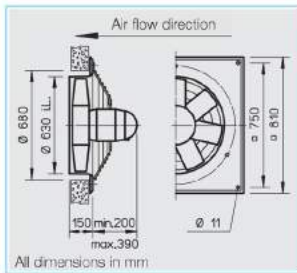

**■ Specification for all models**

- Casing**  
Manufactured in galvanised sheet steel.
- Impeller**  
Highly efficient, profiled blade impeller, dynamically balanced and manufactured from impact resistant polymers. Suitable for -30 to +60 °C. Deviation for ex-models.
- Motor**  
Totally enclosed motor with a die-cast aluminium casing, protected to IP 55. Ball bearing mounted. Maintenance-free and interference-free. Humidity protection of windings. For maximum air flow temperature see table below. Deviation for ex-models.

- Motor protection**  
All models (except .7/8/4 and explosion proof) have thermal contacts as standard which must be connected to a motor protection unit (see below) for effective motor protection. Motors without thermal contacts must be protected by a conventional circuit breaker.
- Electrical connection**  
Terminal box (IP 55) mounted on motor as standard. Also on outside of piping for HRF. Deviation for ex-models.
- Guard**  
Powder-coated steel wire for HQ and HW (HQ.. Ex galvanised) according to DIN EN ISO 13857.

- Speed control**  
For all speed controllable models the current are identified with a value in the "speed controlled" column of the table below which must be used when selecting a controller. Possible allocations of frequency inverters are specified in the table below. The planned use of a frequency inverter without Sine filter must be stated when ordering. This requires a change of fan design and potential additional costs. The air flow rates are shown in the performance curves.
- Reversed operation**  
All models are reversible when wired to a reversing switch. For reverse air flow directional allow a loss in performance of approx. 1/3.

- Installation**  
Installation in any position. Ensure that the motor drainage holes face downwards.
- Dimensions**  
Pole-switch and explosion proof models may deviate from the information above.
- Sound levels**  
See characteristic curve. The sound power and sound pressure are specified at 4 m distances under free field conditions, for average operating point suction/pressure side. See page 10 on for sound emission and acoustics. Deviation for ex-models.

R.P.M.	Air flow volume (FID)	Motor power (nominal)*	Current* standard-supply	Current* max. controlled	Wiring diagram No.	max. air flow temp. standard supply +°C	max. air flow temp. speed controlled +°C	Weight net kg	Model				Transformer controller for 5 speed pole switch			
									HQ incl. guard	Ref. no.	HW incl. guard	Ref. no.	HRF	Ref. no.	Model	Ref. no.
<b>1 Phase motor, 230 Volt / 50 Hz, capacitor motor, protection to IP 55</b>																
950	10530	0.44	2.16	3.20	475	60	40	28.0	HQW 630/6	5037	—	—	—	—	MWS 3 <sup>1)</sup>	1948
1325	16210	1.50*	8.40*	7.00	964	40	—	40.0	HQW 630/4	5056	—	—	HRFW 630/4	5057	MWS 7,5 <sup>1)</sup>	1950
<b>3 Phase motor, 400 Volt / 50 Hz, squirrel cage motor protection to IP 55</b>																
710	7810	0.20	0.66	0.70	469	40	40	27.0	HQD 630/8	5029	—	—	—	—	RDS 2 <sup>1)</sup>	1315
960	10560	0.44	1.22	—	469	60	40	30.5	HQD 630/6	5027	HWD 630/6	1032	HRFD 630/6	0244	RDS 2 <sup>1)</sup>	1315
<b>Two-speed, 3 ph., 400 V, 50 Hz, Y/Δ switch, protection to IP 55</b>																
1170/1390	14310/17000	0.90/1.57	2.3/3.8	—	520	40	—	37.5	HQD 630/4/4	5030	HWD 630/4/4	1033	HRFD 630/4/4	0245	RDS 4 <sup>1)</sup>	1316
<b>2 speed motor, pole-switching, Dahlander windings, 400 Volt, 50 Hz, protection to IP 55</b>																
440/935	5290/10470	0.14/0.43	0.60/1.13	—	472	60	—	41.0	HQD 630/12/6	5031	—	—	HRFD 630/12/6	0410	PDA 12 <sup>2)</sup>	5081
690/1400	7990/15990	0.37/1.50*	1.33/3.70*	—	471	40	—	40.5	HQD 630/8/4	5032	—	—	HRFD 630/8/4	0411	PDA 12 <sup>2)</sup>	5081
<b>Explosion proof Ex e II, 3 ph., 400 Volt, 50 Hz, protection to IP 55, temp. class T1-T3</b>																
910	10480	0.55*	1.75*	—	470	40	—	30.0	HQD 630/6 Ex	5035	—	—	HRFD 630/6 Ex	0494	not permitted	
1410	17730	1.35*	3.10*	—	470	40	—	35.0	HQD 630/4 Ex	5036	—	—	HRFD 630/4 Ex	0495	not permitted	

\*: for nominal value of motor see information on page 16

<sup>1)</sup> Incl. full motor protection

<sup>2)</sup> see switch product page for flush mounted version



### 630/4

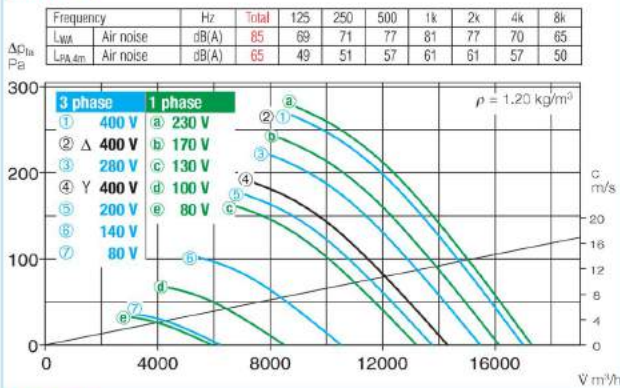

### 630/6

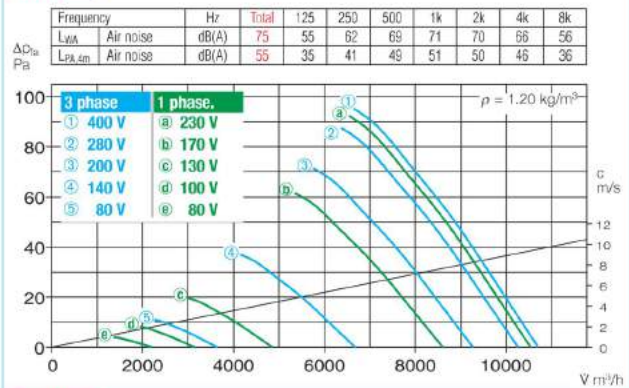

### 630/8

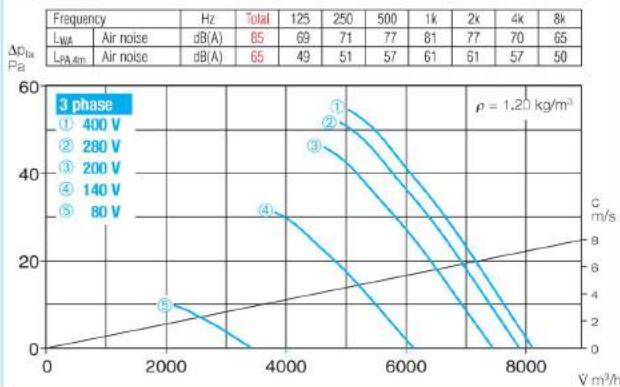

### 630/12

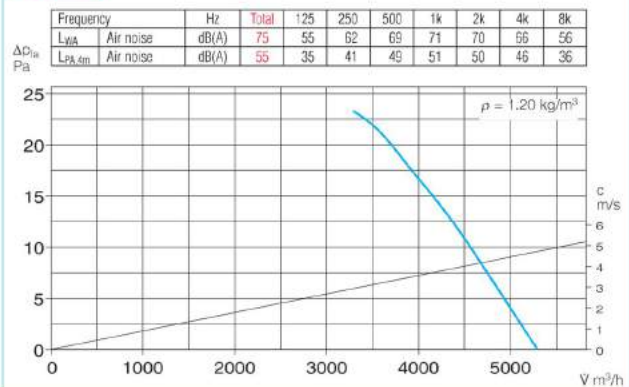

Accessories for HRF Description see page 230 on

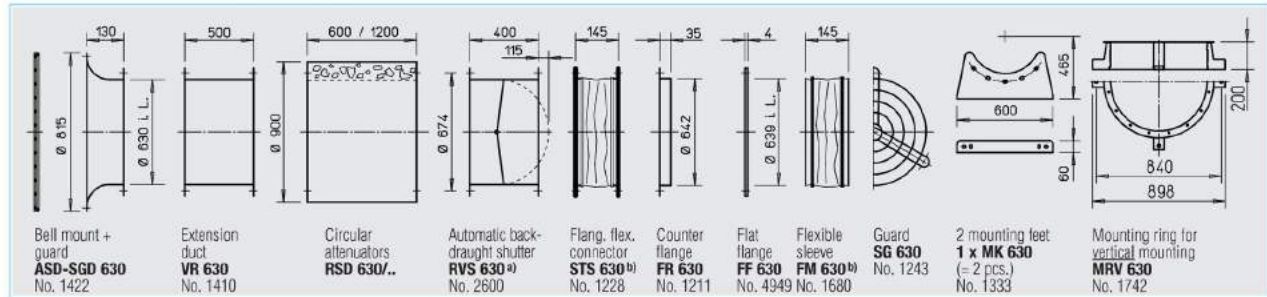

<sup>a)</sup> For motorised shutters see accessory page

<sup>b)</sup> Models for ex-proof fans see below

Frequency inverter with integrated Sine filter		Electronic controller, stepless flush/surf.		Full motor protection for connection of integrated thermal contacts		Reversing switch	
Model	Ref. no.	Model	Ref. no.	Model	Ref. no.	Model	Ref. no.
—	—	ESU 5/ESA 5	1296/1299	MW	1579	WS	1271
—	—	—	—	MW	1579	WS	1271
FU-BS 2,5 <sup>1)</sup>	5459	ESD 5 <sup>1)</sup>	0501	MD	5849	WS	1271
FU-BS 2,5 <sup>1)</sup>	5459	ESD 5 <sup>1)</sup>	0501	MD	5849	WS	1271
FU-BS 5,0 <sup>1)</sup>	5460	ESD 5 <sup>1)</sup>	0501	M 4 <sup>3)</sup>	1571	WS	1271
—	—	—	—	M 3 <sup>3)</sup>	1293	PWDA	1282
—	—	—	—	M 3 <sup>3)</sup>	1293	PWDA	1282
—	—	not permitted	—	—	—	—	—
—	—	not permitted	—	—	—	—	—

<sup>1)</sup> pole switch

Information	Page	Other accessories	Page
Techn. description	140	<sup>b)</sup> Accessories for explosion proof fans	
Selection chart	141	Flanged flexible connector Type STS 630 Ex Ref. no. 2509	
Information for planning	10 on	Flexible sleeve Type FM 630 Ex Ref. no. 1696	
<b>Made to order designs</b>		Attenuators	434 on
Alternative voltages, protection classes, air flow direction, air flow temperature, acid protection and cast aluminium impellers are available on request.		Shutter and grilles	487 on
Note the technical information on page 15 on.		Speed controllers and switches	525 on





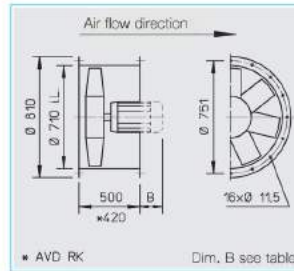
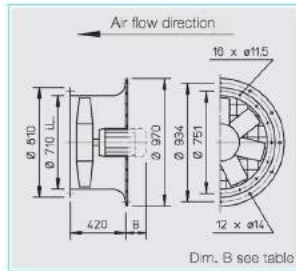
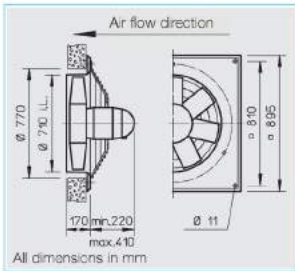

**■ Specification for all models**

- Casing**  
With motor support manufactured from galvanised sheet steel.
- Impeller**  
Highly efficient, profiled blade impeller, dynamically balanced and manufactured from impact resistant polymers. Suitable for -30 to +60 °C. Deviation for ex-models.
- Pitch angle**  
The impeller blades are adjustable for the optimal coverage of the operating point (except HQW 710/6 and explosion proof). The pitch angle is set at the factory (according to the

order) and fixed. The motor allocation takes place using the maximum power pursuant to the information in the table below. The specified pitch angle shown for each motor must not be exceeded.

- Motor**  
Totally enclosed motor protected to IP 55. Maintenance-free and interference-free. Humidity protection of tropicalized windings. Deviation for ex-models.
- Motor protection**  
All models (except pole switching and explosion proof) have thermal contacts or PTC thermistors and according to footnotes in the table to protect

through the following full motor protection units:  
<sup>1)</sup>MW/MD, Ref. no. 1579/5849  
<sup>2)</sup>MSA, Ref. no. 1289  
 (for PTC thermistor temp. sens)  
<sup>3)</sup>M4, Ref. no. 1571  
 All other models have to be protected by a conventional circuit breaker on site.

- Guard**  
Hot-dipped or powder-coated as standard for HQ and AVD DK according to DIN EN ISO 13857.
- Electrical connection**  
Terminal box protected to IP 54 mounted on motor. Outside of piping for HRF. Deviation for ex-models.

**□ Speed control**  
Partial through voltage reduction, see the "transformer controller" column. Regulated performance curve upon request. Possible allocations of frequency inverters for all types (except pole-switch and ex-proof). The planned use of a frequency inverter without Sine filter must be stated when ordering. This requires a change of fan design and potential additional costs.

**□ Reversed operation**  
All models are reversible when wired to a reversing switch. For reverse air flow direction allow a loss in performance of approx. 1/3.

**□ Installation**  
Installation in any position. Ensure that the motor drainage holes face downwards.

**□ Dimensions**  
Pole-switch and explosion proof models may deviate from the adjacent information. Motor build lengths vary. Note dimension B projection.

**□ Sound levels**  
The sound power levels are specified through the frequency and as sum levels above the characteristic curves. Deviation for ex-models.

R.P.M.	Air flow volume (FID)	Motor power (nominal)*	Voltage	Power con. nom. volt./ (control)*	max. pitch angle	Wiring diagram	max. air flow temp.	Weight net <sup>1)</sup>	Model				Dim. B motor projection	Transformer controller for 5 speed pole switch			
									HQ incl. guard	Ref. no.	AVD DK incl. guard	Ref. no.		HRFD, AVD RK	Ref. no.	Model	Ref. no.
min <sup>-1</sup>	∇ m <sup>3</sup> /h	kW	V	A	°	No.	+°C	kg					mm				
<b>1 Phase motor, 230 Volt / 50 Hz, capacitor motor, protection to IP 55</b>																	
910	14200	0.60	230	2.6	25	965	40	40.0	HQW 710/6 <sup>1)</sup>	5047	—	—	—	—	MWS 5 <sup>4)</sup>	1949	
<b>3 Phase motor, 400 Volt / 50 Hz, squirrel cage motor protection to IP 55</b>																	
690	13330	0.29	400	0.9	20	469	40	57.0	HQD 710/8 <sup>1)</sup>	5599	AVD DK 710/8 <sup>1)</sup>	5251	HRFD 710/8 <sup>1)</sup>	6930	95	RDS 2 <sup>4)</sup>	1315
940	15560/19170	1.1*	230/400	5.1*	35	499	40	60.0	HQD 710/6 <sup>1)</sup>	5603	AVD DK 710/6 <sup>1)</sup>	5255	HRFD 710/6 <sup>1)</sup>	6934	135	RDS 7 <sup>4)</sup>	1578
1445	26420	3.00*	400/690	6.2*	30	776	40	88.0	HQD 710/4 <sup>2)</sup>	5606	AVD DK 710/4 <sup>2)</sup>	5258	HRFD 710/4 <sup>2)</sup>	6937	180	—	—
<b>Two-speed, 3 ph., 400 V, 50 Hz, protection to IP 55</b>																	
730/890	13550/16090	0.4/0.75*	400/400	1.1/2.3*	25	520	40	55.0	HQD 710/6/6 <sup>3)</sup>	5602	AVD DK 710/6/6 <sup>3)</sup>	5254	HRFD 710/6/6 <sup>3)</sup>	6933	95	RDS 4 <sup>4)</sup>	1316
1120/1360	16140/19670	0.95/1.55*	400/400	2.4/4.2*	20	520	40	60.0	HQD 710/4/4 <sup>3)</sup>	5604	AVD DK 710/4/4 <sup>3)</sup>	5256	HRFD 710/4/4 <sup>3)</sup>	6935	135	RDS 7 <sup>4)</sup>	1578
1030/1340	19370/23280	1.5/2.2*	400/400	3.0/5.2*	26	520	40	75.0	HQD 710/4/4 <sup>3)</sup>	5605	AVD DK 710/4/4 <sup>3)</sup>	5257	HRFD 710/4/4 <sup>3)</sup>	6936	180	RDS 7 <sup>4)</sup>	1578
<b>2 speed motor, pole-switching, Dahlander windings, 400 Volt, 50 Hz, protection to IP 54</b>																	
685/1430	10810/22090	0.5/2.0*	400/400	2.0/4.7	23	471	40	82.0	HQD 710/8/4/..	5611	AVD DK 710/8/4/..	5263	HRFD 710/8/4/..	6942	180	PDA 12 <sup>5)</sup>	5081
720/1440	14155/29020	0.9/3.6*	400/400	2.9/8.3	30	471	40	108.0	HQD 710/8/4/..	5612	AVD DK 710/8/4/..	5264	AVD RK 710/8/4/..	6943	210	PDA 12 <sup>5)</sup>	5081
<b>Explosion proof Ex e II, 3 ph., 400 Volt, 50 Hz, protection to IP 55, temp. class T1-T3</b>																	
700	10450	0.55*	400	2.2*	35	470	40	68.0	HQD 710/8 Ex	5618	AVD DK 710/8 Ex	5270	HRFD 710/8 Ex	6948	125	not permitted	
930	13480	0.55*	400	1.8*	25	470	40	67.0	HQD 710/6 Ex	5620	AVD DK 710/6 Ex	5272	HRFD 710/6 Ex	6949	95	not permitted	
930	16770	0.95*	400	2.7*	35	470	40	77.0	HQD 710/6 Ex	5621	AVD DK 710/6 Ex	5273	HRFD 710/6 Ex	6950	135	not permitted	
1420	20540	2.00*	400	4.7*	25	470	40	82.0	HQD 710/4 Ex	5623	AVD DK 710/4 Ex	5275	AVD RK 710/4 Ex	6951	180	not permitted	
1420	26160	3.60*	400/690	8.1*	35	498	40	102.0	HQD 710/4 Ex	5624	AVD DK 710/4 Ex	5276	AVD RK 710/4 Ex	6952	200	not permitted	

<sup>1)</sup> Motor amounts, Ex see info p. 16.

<sup>2)</sup> to <sup>3)</sup> full motor protection unit, see "Motor protection" desc.

<sup>4)</sup> Weights apply for type ..DK and ..RK, HRF and HQ less approx. 15 kg.

<sup>5)</sup> Incl. full motor protection.





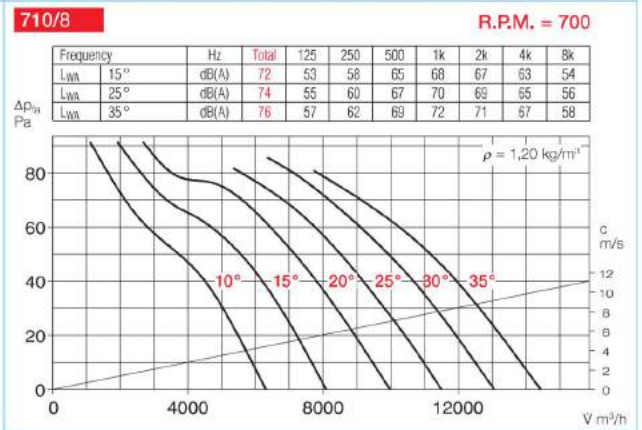
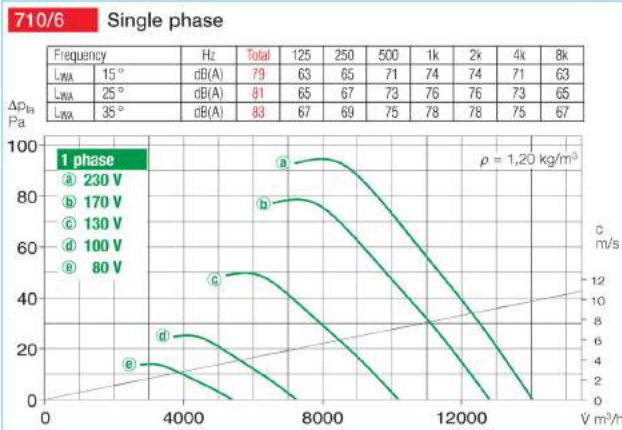
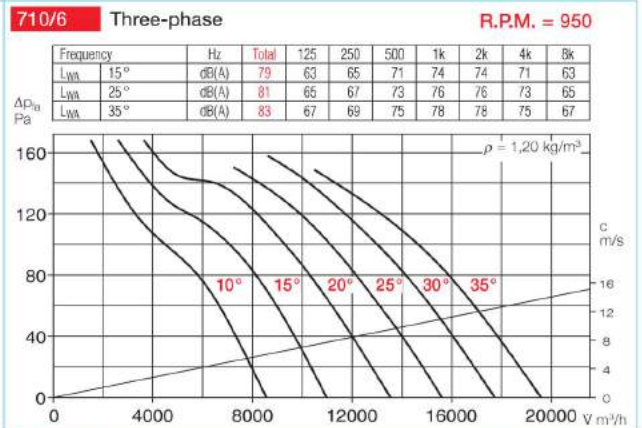
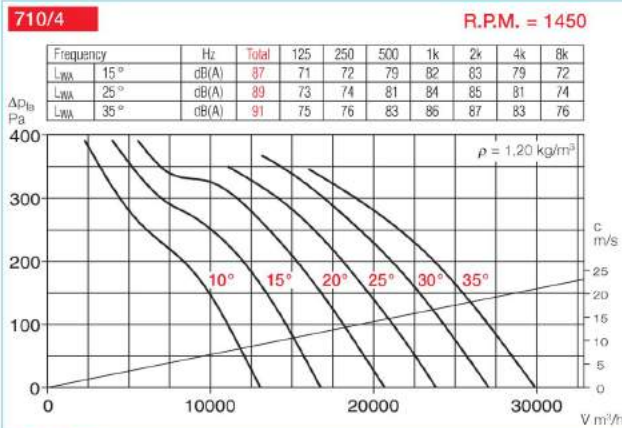

Electronic controller, stepless Frequency inverter with Sine filter		Vibration dampers nominal size	
Model	Ref. no.	Model	Ref. no.
—	—	..1/.1	1452/1454
ESD 5 <sup>4)</sup>	0501	..1/.1	1452/1454
ESD 11,5 <sup>4)</sup>	0502	..1/.1	1452/1454
FU-BS 8,0 <sup>4)</sup>	5461	..2/.2	1453/1455
ESD 5 <sup>4)</sup>	0501	..1/.1	1452/1454
ESD 5 <sup>4)</sup>	0501	..1/.1	1452/1454
ESD 11,5 <sup>4)</sup>	0502	..1/.2	1452/1455
—	—	..2/.2	1453/1455
—	—	..2/.2	1453/1455
not permitted	—	..1/.2	1452/1455
not permitted	—	..1/.2	1452/1455
not permitted	—	..1/.2	1452/1455
not permitted	—	..2/.2	1453/1455
not permitted	—	..2/.2	1453/1455

with product page for flush mounted version.

Accessories for HRF / AVD RK Description see page 230 on

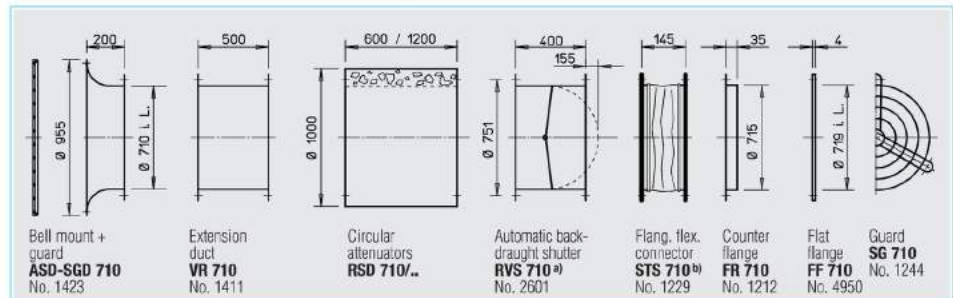

<sup>3)</sup> For motorised shutters see accessory page

<sup>4)</sup> Models for ex-proof fans see below

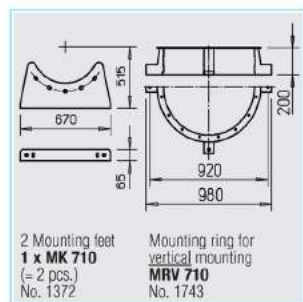

Information	Page	Other accessories	Page
Techn. description	140	<sup>b)</sup> Accessories for explosion proof fans	Type STS 710 Ex Ref. no. 2510
Selection chart	141		
Information for planning	10 on		
<b>Made to order designs</b>		Attenuators	434 on
Alternative voltages, protection classes, air flow direction, air flow temperature, acid protection and cast aluminium impellers are available on request.		Shutter and grilles	487 on
		Speed controllers and switches	525 on





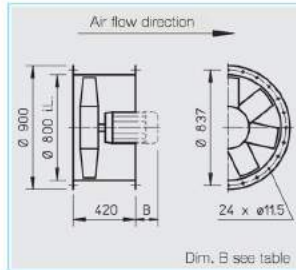
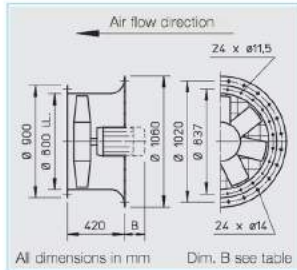

**Specification for all models**

**Casing**

With motor support manufactured from galvanised sheet steel.

**Impeller**

Highly efficient, profiled blade impeller, dynamically balanced and manufactured from impact resistant polymers. Suitable for -30 to +60 °C. Deviation for ex-models.

**Pitch angle**

The impeller blades are adjustable for the optimal coverage of the operating point (except explosion proof). The pitch angle is set at the factory (according to the order) and fixed. The motor allocation takes place using the maximum power pursuant to the information in the table below. The specified pitch angle shown for each motor must not be exceeded.

**Motor**

Totally enclosed motor protected to IP 55. Maintenance-free and interference-free. Humidity protection of tropicalized windings. Deviation for ex-models.

**Motor protection**

All models (except pole switching and explosion proof) have thermal contacts or PTC thermistors and according to footnotes in the table to protect through the following full motor protection units:  
<sup>1)</sup>MSA, Ref. no. 1289 (for PTC thermistor temp. sens)  
<sup>2)</sup>M4, Ref. no. 1571  
 All other models have to be protected by a conventional circuit breaker on site.

**Electrical connection**

Terminal box protected to IP 54 mounted on motor.

**Guard**

According to DIN EN ISO 13857, hot-dip galvanised, as standard for AVD DK.

**Speed control**

Partial through voltage reduction, see the "transformer controller" column. Regulated performance curve upon request. Possible allocations of frequency inverters for all types (except pole-switch and ex-proof). The planned use of a frequency inverter without Sine filter must be stated when ordering. This requires a change of fan design and potential additional costs.

**Reversed operation**

All models are reversible when wired to a reversing switch. For reverse air flow direction allow a loss in performance of approx. 1/3.

**Installation**

Installation in any position. Ensure that the motor drainage holes face downwards.

**Dimensions**

Pole-switch and explosion proof models may deviate from the adjacent information. Motor build lengths vary. Note dimension B projection.

**Sound levels**

The sound power levels are specified through the frequency and as sum levels above the characteristic curves. Deviation for ex-models.

R.P.M.	Air flow volume (FD)	Motor power (nominal)*	Voltage	Power con. nom. volt.*	max. pitch angle	Wiring diagram	max. air flow temp.	Weight net	Model				Dim. B motor projection	Transformer controller for 5 speed pole switch	
									AVD DK incl. guard	Ref. no.	AVD RK	Ref. no.		Model	Ref. no.
min <sup>-1</sup>	∇ m <sup>3</sup> /h	kW	V	A	°	No.	+°C	kg					mm	Model	Ref. no.
<b>Three phase, 50 Hz, squirrel-cage motor, protection to IP 54</b>															
1445	33450	4.00*	400/690	8.3*	26	776	40	101	AVD DK 800/4/.. <sup>4)</sup>	5311	AVD RK 800/4/.. <sup>4)</sup>	6960	210	—	—
1450	39130	5.5*	400/690	11*	33	776	40	115	AVD DK 800/4/.. <sup>4)</sup>	5312	AVD RK 800/4/.. <sup>4)</sup>	6961	290	—	—
<b>Two-speed, 3 ph., 400 V, 50 Hz, protection to IP 55</b>															
775/920	15720/18670	0.40/0.75*	400/400	1.1/2.3*	22	520	40	70	AVD DK 800/6/6/.. <sup>3)</sup>	5307	AVD RK 800/6/6/.. <sup>3)</sup>	6956	125	RDS 4 <sup>2)</sup>	1316
<b>Pole-switchable, 2-speed, 3 ph., 50 Hz, protection to IP 54</b>															
695/1400	10020/20180	0.37/1.50*	400/400	1.3/3.7*	25	471	40	95	AVD DK 800/8/4/.. <sup>1)</sup>	5319	AVD RK 800/8/4/.. <sup>1)</sup>	6968	135	PDA 12 <sup>3)</sup>	5081
<b>Explosion proof Ex e II, 3 ph., 50 Hz, protection to IP 55, temp. class T1-T3</b>															
700	17190	0.55*	400	2.2*	32	470	40	81	AVD DK 800/8 Ex/..	5326	AVD RK 800/8 Ex/..	6974	135	not permitted	
930	20340	0.95*	400	2.7*	23	470	40	90	AVD DK 800/6 Ex/..	5329	AVD RK 800/6 Ex/..	6976	135	not permitted	
950	26710	1.9*	400	4.7*	35	470	40	118	AVD DK 800/6 Ex/..	5330	AVD RK 800/6 Ex/..	6977	210	not permitted	
1420	31900	3.60*	400/690	8.1*	24	498	40	115	AVD DK 800/4 Ex/..	5332	AVD RK 800/4 Ex/..	6978	210	not permitted	
1450	36820	5.00*	400/690	10.1*	30	498	40	143	AVD DK 800/4 Ex/..	5333	AVD RK 800/4 Ex/..	6979	290	not permitted	

\* All motor amounts, Ex see info p. 16.

<sup>1)</sup> Dahlander winding.

<sup>2)</sup> Incl full motor protection.

<sup>3)</sup> see switch product page for flush mounted version.



### 800/4 R.P.M. = 1450

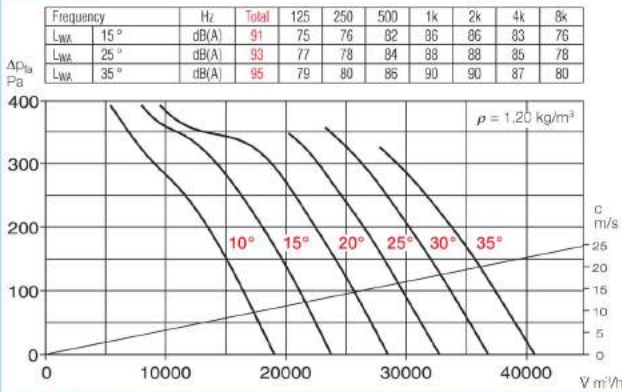

### 800/6 R.P.M. = 945

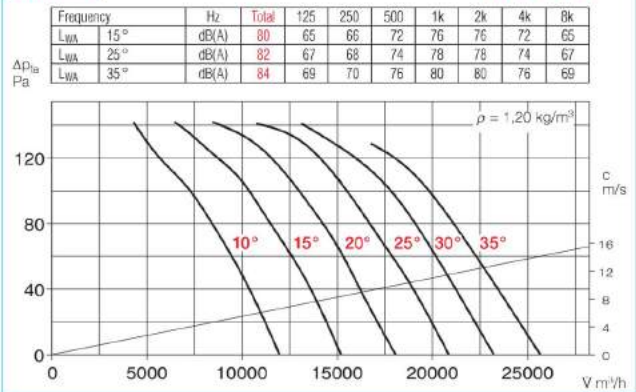

### 800/8 R.P.M. = 705

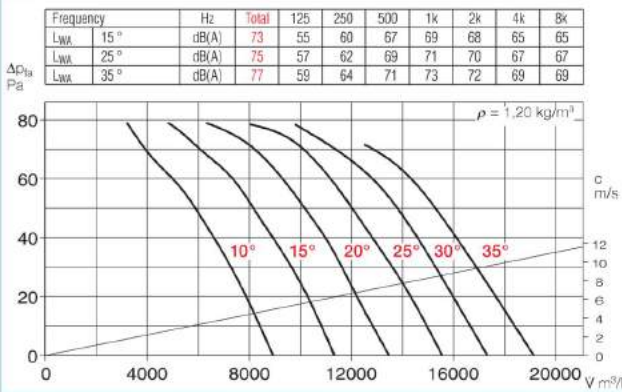

Accessories for AVD RK Description see page 230 on

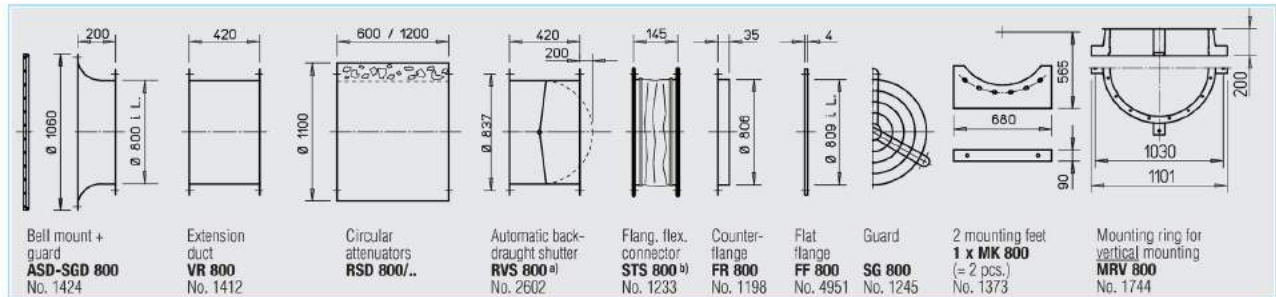

<sup>a)</sup> For motorised shutters see accessory page

<sup>b)</sup> Models for ex-proof fans see below

Electronic controller, stepless Frequency inverter with Sine filter		Vibration dampers nominal size	
Model	Ref. no.	Model	Ref. no.
FU-BS 10 <sup>2)</sup>	5462	..2/..2	1453/1455
FU-BS 14 <sup>2)</sup>	5463		
ESD 5 <sup>2)</sup>	0501	..2/..2	1453/1455
—	—	..2/..2	1453/1455
not permitted	..2/..2	1453/1455	
not permitted	..2/..2	1453/1455	
not permitted	..2/..2	1453/1455	
not permitted	..2/..2	1453/1455	
not permitted	..2/..2	1453/1455	

<sup>4)</sup> 2003 Motor protection see description "Motor protection".

Information	Page	Other accessories	Page
Techn. description	140		
Selection chart	141		
Information for planning	10 on	<sup>b)</sup> Accessories for explosion proof fans	
<b>Made to order designs</b> Alternative voltages, protection classes, air flow direction, air flow temperature, acid protection and cast aluminium impellers are available on request.		<b>Flanged flexible connector Type STS 800 Ex</b> Ref. no. 2511	
Note the technical information on page 15 on.		Attenuators	434 on
		Shutter and grilles	487 on
		Speed controllers and switches	525 on





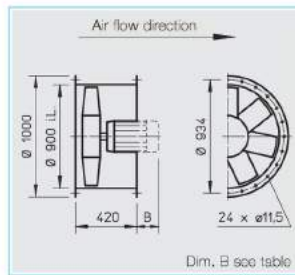
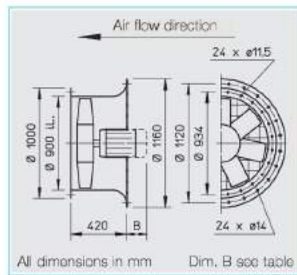

**Specification for all models**

**Casing**

With motor support manufactured from galvanised sheet steel.

**Impeller**

Highly efficient, profiled blade impeller, dynamically balanced and manufactured from impact resistant polymers. Suitable for -30 to +60 °C. Deviation for ex-models.

**Pitch angle**

The impeller blades are adjustable for the optimal coverage of the operating point (except explosion proof). The pitch angle is set at the factory (according to the order) and fixed. The motor allocation takes place using the maximum power pursuant to the information in the table below. The specified pitch angle shown for each motor must not be exceeded.

**Motor**

Totally enclosed motor protected to IP 55. Maintenance-free and interference-free. Humidity protection of tropicalized windings. Deviation for ex-models.

**Motor protection**

All models (except pole switching and explosion proof) have thermal contacts or PTC thermistors and according to footnotes in the table to protect through the following full motor protection units:  
<sup>1)</sup>MSA, Ref. no. 1289 (for PTC thermistor temp. sens)  
<sup>2)</sup>M4, Ref. no. 1571  
 All other models have to be protected by a conventional circuit breaker on site.

**Electrical connection**

Terminal box protected to IP 54 mounted on motor.

**Guard**

According to DIN EN ISO 13857, hot-dip galvanised, as standard for AVD DK.

**Speed control**

Partial through voltage reduction, see the "transformer controller" column, Regulated performance curve upon request. Possible allocations of frequency inverters for all types (except pole-switch and ex-proof). The planned use of a frequency inverter without Sine filter must be stated when ordering. This requires a change of fan design and potential additional costs.

**Reversed operation**

All models are reversible when wired to a reversing switch. For reverse air flow direction allow a loss in performance of approx. 1/3.

**Installation**

Installation in any position. Ensure that the motor drainage holes face downwards.

**Dimensions**

Pole-switch and explosion proof models may deviate from the adjacent information. Motor build lengths vary. Note dimension B projection.

**Sound levels**

The sound power levels are specified through the frequency and as sum levels above the characteristic curves. Deviation for ex-models.

R.P.M.	Air flow volume (FD)	Motor power (nominal)*	Voltage	Power con. nom. volt.*	max. pitch angle	Wiring diagram	max. air flow temp.	Weight net	Model		Dim. B motor projection	Transformer controller for 5 speed pole switch		
									AVD DK incl. guard	Ref. no.		AVD RK	Ref. no.	Model
min <sup>-1</sup>	V m <sup>3</sup> /h	kW	V	A	°	No.	+°C	kg			mm			
<b>Three phase, 50 Hz, squirrel-cage motor, protection to IP 54</b>														
950	37300	3.00*	400/690	6.2*	34	776	40	130	AVD DK 900/6/.. <sup>4)</sup>	5369	AVD RK 900/6/.. <sup>4)</sup>	6985	290	—
1445	35030	4.00*	400/690	8.3*	16	776	40	118	AVD DK 900/4/.. <sup>4)</sup>	5370	AVD RK 900/4/.. <sup>4)</sup>	6986	210	—
1450	48995	7.50*	400/690	14.5*	27	776	40	142	AVD DK 900/4/.. <sup>4)</sup>	5371	AVD RK 900/4/.. <sup>4)</sup>	6987	325	—
1470	57720	11.00*	400/690	20.0*	34	776	40	186	AVD DK 900/4/.. <sup>4)</sup>	5372	AVD RK 900/4/.. <sup>4)</sup>	6988	385	—
<b>Two-speed, 3 ph., 400 V, 50 Hz, Y/Δ switch, protection to IP 55</b>														
755/930	18390/22660	0.71/1.32*	400/400	2.1/4.0*	19	520	40	90	AVD DK 900/6/6/.. <sup>5)</sup>	5367	AVD RK 900/6/6/.. <sup>5)</sup>	6983	180	RDS 7 <sup>2)</sup> 1578
770/920	25990/31060	1.38/2.37*	400/400	3.9/7.1*	27	520	40	115	AVD DK 900/6/6/.. <sup>5)</sup>	5368	AVD RK 900/6/6/.. <sup>5)</sup>	6984	210	RDS 11 <sup>2)</sup> 1332
<b>Pole-switchable, 2-speed, 3 ph., 50 Hz, protection to IP 54</b>														
700/1435	18270/37450	1.10/4.50*	400/400	2.9/9.6*	18	471	40	120	AVD DK 900/8/4/.. <sup>1)</sup>	5379	AVD RK 900/8/4/.. <sup>1)</sup>	6995	290	PDA 12 <sup>3)</sup> 5081
715/1450	22390/45410	1.80/6.50*	400/400	5.7/14.5*	24	471	40	148	AVD DK 900/8/4/.. <sup>1)</sup>	5380	AVD RK 900/8/4/.. <sup>1)</sup>	6996	325	PDA 25 <sup>3)</sup> 5060
<b>Explosion proof Ex e II, 3 ph., 50 Hz, protection to IP 55, temp. class T1-T3</b>														
700	24470	0.95*	400	2.8*	27	470	40	110	AVD DK 900/8 Ex/..	5386	AVD RK 900/8 Ex/..	6899	180	not permitted
725	28470	1.3*	400	3.9*	34	470	40	130	AVD DK 900/8 Ex/..	5387	AVD RK 900/8 Ex/..	6900	210	not permitted
950	30550	1.90*	400	4.7*	25	470	40	135	AVD DK 900/6 Ex/..	5389	AVD RK 900/6 Ex/..	6901	210	not permitted
960	38040	3.50*	400/690	7.4*	35	498	40	160	AVD DK 900/6 Ex/..	5390	AVD RK 900/6 Ex/..	6902	290	not permitted
1450	46630	6.80*	400/690	13.6*	25	498	40	175	AVD DK 900/4 Ex/..	5392	AVD RK 900/4 Ex/..	6903	325	not permitted
1465	55240	10.00*	400/690	19.8*	32	498	40	235	AVD DK 900/4 Ex/..	5393	AVD RK 900/4 Ex/..	6904	385	not permitted

\* at motor amounts, Ex see info p. 16.

<sup>1)</sup> Dahlander winding.

<sup>2)</sup> Incl full motor protection.

<sup>3)</sup> see switch product page for flush mounted version.



### 900/4 R.P.M. = 1450

Frequency	Hz	Total	125	250	500	1k	2k	4k	8k
LWA 15°	dB(A)	94	78	80	86	90	90	86	79
LWA 25°	dB(A)	96	80	82	88	92	92	88	81
LWA 35°	dB(A)	98	82	84	90	94	94	90	83

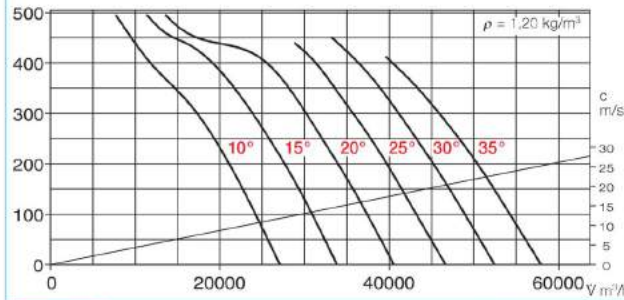

### 900/6 R.P.M. = 945

Frequency	Hz	Total	125	250	500	1k	2k	4k	8k
LWA 15°	dB(A)	84	69	70	76	79	79	76	68
LWA 25°	dB(A)	86	71	72	78	81	81	78	70
LWA 35°	dB(A)	88	73	74	80	83	83	80	72

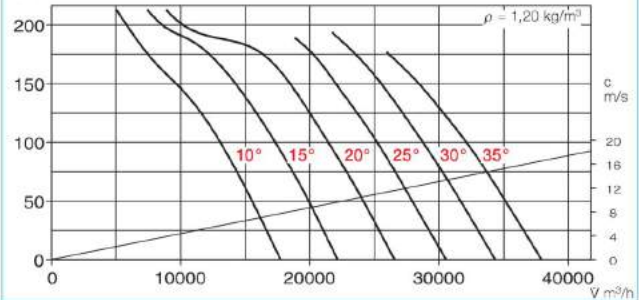

### 900/8 R.P.M. = 705

Frequency	Hz	Total	125	250	500	1k	2k	4k	8k
LWA 15°	dB(A)	77	58	64	71	73	72	68	59
LWA 25°	dB(A)	79	60	66	73	75	74	70	61
LWA 35°	dB(A)	81	62	68	75	77	76	72	63

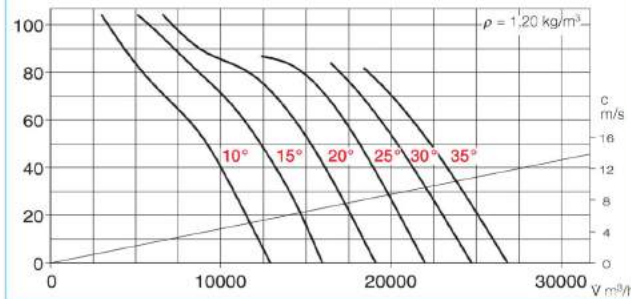

Axial and VAR fans

### Accessories for AVD RK Description see page 230 on

Electronic controller, stepless Frequency inverter with Sine filter		Vibration dampers nominal size	
Model	Ref. no.	Model	Ref. no.
FU-BS 8.0 <sup>2)</sup>	5461	..2/..2	1453/1455
FU-BS 10 <sup>2)</sup>	5462	..3/..3	1367/1366
FU-CS 18 <sup>2)</sup>	5469	..3/..3	1367/1366
FU-CS 22 <sup>2)</sup>	5470	..3/..3	1367/1366
ESD 5 <sup>2)</sup>	0501	..2/..2	1453/1455
ESD 11 <sup>2)</sup>	0502	..2/..2	1453/1455
—	—	..2/..2	1453/1455
—	—	..2/..2	1453/1455
not permitted	..2/..2	1453/1455	
not permitted	..2/..2	1453/1455	
not permitted	..2/..2	1453/1455	
not permitted	..2/..2	1453/1455	
not permitted	..3/..3	1367/1366	
not permitted	..3/..3	1367/1366	

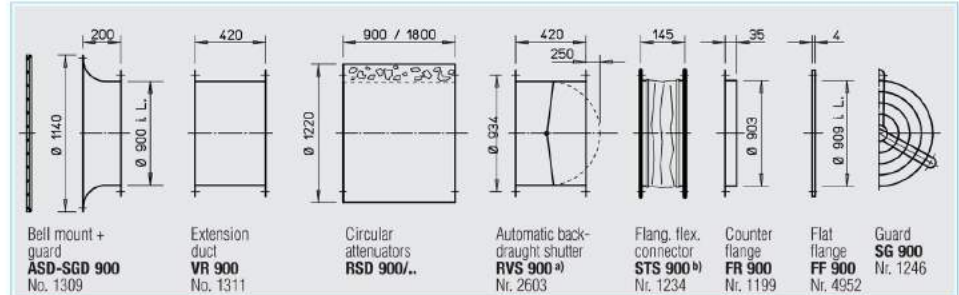

<sup>a)</sup> For motorised shutters see accessory page

<sup>b)</sup> Models for ex-proof fans see below

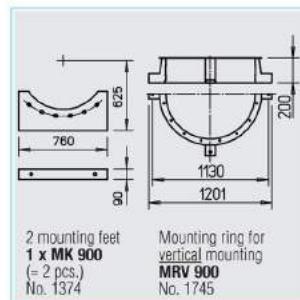

Information	Page	Other accessories	Page
Techn. description	140	<sup>b)</sup> Accessories for explosion proof fans	Type STS 900 Ex Ref. no. 2512
Selection chart	141		
Information for planning	10 on		
<b>Made to order designs</b>			
Alternative voltages, protection classes, air flow direction, air flow temperature, acid protection and cast aluminium impellers are available on request.		Attenuators	434 on
		Shutter and grilles	487 on
		Speed controllers and switches	525 on



<sup>4)</sup> and <sup>5)</sup> full description, see description "Motor protection".



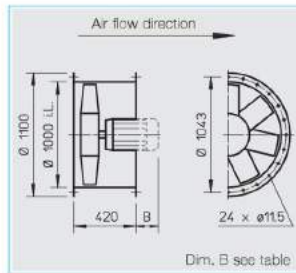
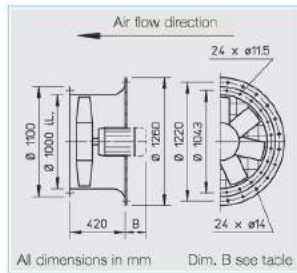

**■ Specification for all models**

**□ Casing**

With motor support manufactured from galvanised sheet steel.

**□ Impeller**

Highly efficient, profiled blade impeller, dynamically balanced and manufactured from impact resistant polymers. Suitable for -30 to +60 °C. Deviation for ex-models.

**□ Pitch angle**

The impeller blades are adjustable for the optimal coverage of the operating point (except explosion proof). The pitch angle is set at the factory (according to the order) and fixed. The motor allocation takes place using the maximum power pursuant to the information in the table below. The specified pitch angle shown for each motor must not be exceeded.

**□ Motor**

Totally enclosed motor protected to IP 55. Maintenance-free and interference-free. Humidity protection of tropicalized windings. Deviation for ex-models.

**□ Motor protection**

All models (except pole switching and explosion proof) have thermal contacts or PTC thermistors and according to foot-notes in the table to protect through the following full motor protection units:  
<sup>4</sup>MSA, Ref. no. 1289 (for PTC thermistor temp. sens)  
<sup>5</sup>M4, Ref. no. 1571  
 All other models have to be protected by a conventional circuit breaker on site.

**□ Electrical connection**

Terminal box protected to IP 54 mounted on motor.

**□ Guard**

According to DIN EN ISO 13857, hot-dip galvanised, as standard for AVD DK.

**□ Speed control**

Partial through voltage reduction, see the "transformer controller" column. Regulated performance curve upon request. Possible allocations of frequency inverters for all types (except pole-switch and ex-proof). The planned use of a frequency inverter without Sine filter must be stated when ordering. This requires a change of fan design and potential additional costs.

**□ Reversed operation**

All models are reversible when wired to a reversing switch. For reverse air flow direction allow a loss in performance of approx. 1/3.

**□ Installation**

Installation in any position. Ensure that the motor drainage holes face downwards.

**□ Dimensions**

Pole-switch and explosion proof models may deviate from the adjacent information. Motor build lengths vary. Note dimension B projection.

**□ Sound levels**

The sound power levels are specified through the frequency and as sum levels above the characteristic curves. Deviation for ex-models.

R.P.M.	Air flow volume (FID)	Motor power (nominal)*	Voltage	Power con. nom. volt.*	max. pitch angle	Wiring diagram	max. air flow temp.	Weight net	Model				Dim. B motor projection	Transformer controller for 5 speed pole switch		
									AVD DK incl. guard	Ref. no.	AVD RK	Ref. no.		Model	Ref. no.	
min <sup>-1</sup>	l m <sup>3</sup> /h	kW	V	A	°	No.	+°C	kg				mm	Model	Ref. no.		
<b>Three phase, 50 Hz, squirrel-cage motor, protection to IP 54</b>																
950	39720	3.0*	400/690	6.2*	23	776	40	120	AVD DK 1000/6/.. <sup>4)</sup>	5398	AVD RK 1000/6/.. <sup>4)</sup>	5573	290	—	—	
955	46320	4.0*	400/690	9.2*	29	776	40	127	AVD DK 1000/6/.. <sup>4)</sup>	5399	AVD RK 1000/6/.. <sup>4)</sup>	5574	325	—	—	
955	52450	5.5*	400/690	12.4*	35	776	40	145	AVD DK 1000/6/.. <sup>4)</sup>	5400	AVD RK 1000/6/.. <sup>4)</sup>	5575	325	—	—	
1470	61460	11.0*	400/690	20.0*	23	776	40	160	AVD DK 1000/4/.. <sup>4)</sup>	5401	AVD RK 1000/4/.. <sup>4)</sup>	5576	385	—	—	
1470	71290	15.0*	400/690	26.0*	29	776	40	195	AVD DK 1000/4/.. <sup>4)</sup>	5402	AVD RK 1000/4/.. <sup>4)</sup>	5577	430	—	—	
1475	79440	18.5*	400/690	35.0*	34	776	40	210	AVD DK 1000/4/.. <sup>4)</sup>	5403	AVD RK 1000/4/.. <sup>4)</sup>	5578	465	—	—	
<b>Pole-switchable, 2-speed, 3 ph., 50 Hz, protection to IP 54</b>																
715/1440	27410/55210	2.2/9.0*	400/400	7.2/19.0*	20	471	40	165	AVD DK 1000/8/4/.. <sup>1)</sup>	5407	AVD RK 1000/8/4/.. <sup>1)</sup>	5582	385	PDA 25 <sup>3)</sup>	5060	
715/1445	32325/65330	3.0/12.0*	400/400	9.4/25.0*	26	471	40	190	AVD DK 1000/8/4/.. <sup>1)</sup>	5408	AVD RK 1000/8/4/.. <sup>1)</sup>	5583	415	PDA 63 <sup>3)</sup>	1283	
<b>Explosion proof Ex e II, 3 ph., 50 Hz, protection to IP 55, temp. class T1-T3</b>																
955	43180	3.5*	400/690	7.4*	26	498	40	130	AVD DK 1000/6 Ex/..	5415	AVD RK 1000/6 Ex/..	5590	325	not permitted		
960	52730	6.6*	400/690	13.4*	35	498	40	155	AVD DK 1000/6 Ex/..	5416	AVD RK 1000/6 Ex/..	5591	400	not permitted		
1480	70160	15.0*	400/690	27.5*	28	498	40	200	AVD DK 1000/4 Ex/..	5417	AVD RK 1000/4 Ex/..	5592	430	not permitted		
1470	77600	17.5*	400/690	33.0*	33	498	40	225	AVD DK 1000/4 Ex/..	5418	AVD RK 1000/4 Ex/..	5593	470	not permitted		

\* nominal motor amounts, Ex see info p. 16.

<sup>1)</sup> Dahlander winding.

<sup>2)</sup> Incl full motor protection.

<sup>3)</sup> see switch product page for flush mounted version.



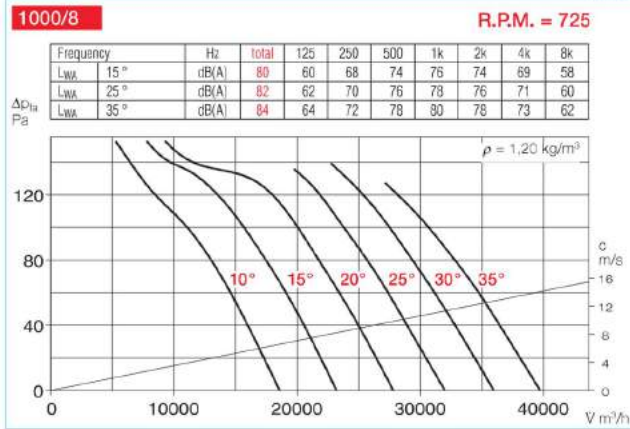
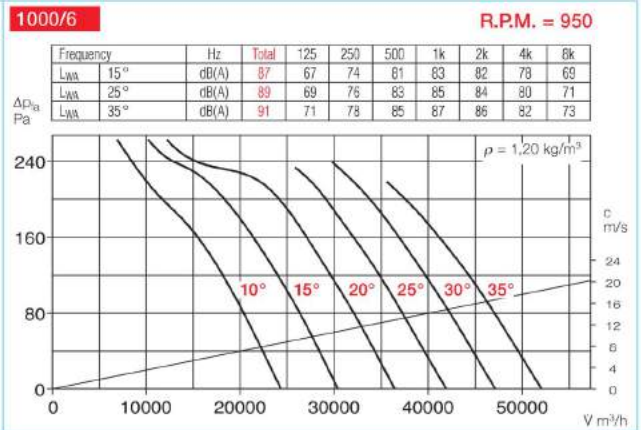
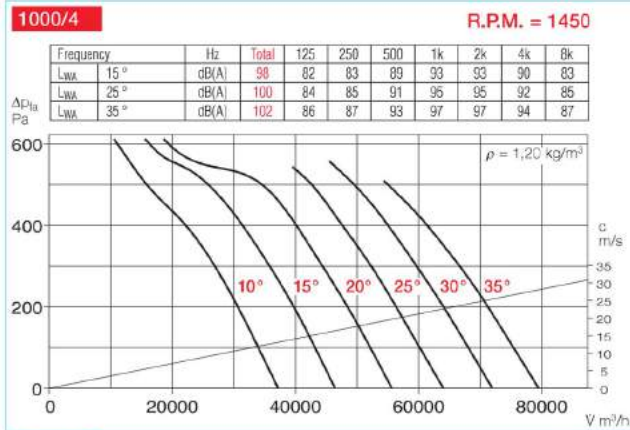

Accessories for AVD RK Description see page 230 on

Electronic controller, stepless Frequency inverter with Sine filter		Vibration dampers nominal size	
Model	Ref. no.	Model	Ref. no.
FU-BS 8,0 <sup>2)</sup>	5461	..2/..2	1453/1455
FU-BS 10,0 <sup>2)</sup>	5462	..2/..2	1453/1455
FU-BS 10,0 <sup>2)</sup>	5462	..2/..2	1453/1455
FU-CS 22 <sup>2)</sup>	5470	..3/..3	1367/1366
FU-CS 32 <sup>2)</sup>	5471	..3/..3	1367/1366
FU-CS 40 <sup>2)</sup>	5472	..3/..3	1367/1366
—	—	..3/..3	1367/1366
—	—	..3/..3	1367/1366
not permitted	..2/..2	1453/1455	
not permitted	..2/..2	1453/1455	
not permitted	..3/..3	1367/1366	
not permitted	..3/..3	1367/1366	

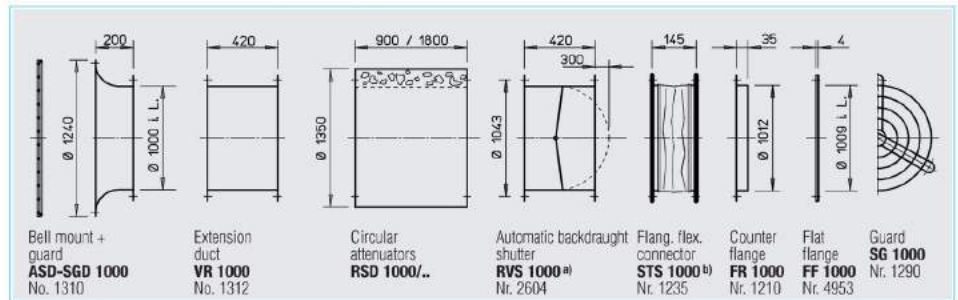

<sup>a)</sup> For motorised shutters see accessory page

<sup>b)</sup> Models for ex-proof fans see below

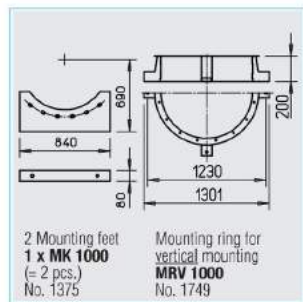

Information	Page	Other accessories	Page
Techn. description	140	<b>Accessories for explosion proof fans</b>	
Selection chart	141		
Information for planning	10 on		
<b>Made to order designs</b>			
Alternative voltages, protection classes, air flow direction, air flow temperature, acid protection and cast aluminium impellers are available on request.			
		<b>Flanged flexible connector Type STS 1000 Ex</b> Ref. no. 2513	
		Attenuators	434 on
		Shutter and grilles	487 on
		Speed controllers and switches	525 on



Motor protection, see description "Motor protection".