

KENNEDY PROFESSIONAL Side Drive Sockets

The Ken-Grip® socket offers a new standard of performance with the ability to grip fasteners which are up to 95% rounded off. A unique patented socket design grips new, worn and rusted fasteners without damaging them further. Double knurl feature gives a high grip which is essential for quick tool change when hands are greasy or oily. Manufactured from chrome vanadium steel, the sockets and accessories are aluminium free, fully chrome plated for a corrosion resistant, easy clean finish. The set features an extensive selection of socket sizes for use across a wide range of fasteners.

KENGRIP® Patented Design



Will grip new, worn and rusted fasteners without damaging them further



Will grip fasteners which are up to 95% rounded off

Will also fit a wide range of non-metric Hexagons, E-Torx® and Spline Drive Sizes.

Standard Length Sockets

Conform to **DIN3124**.

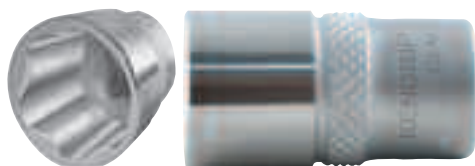

1/4" Square Drive

Size	Overall Length	Weight each	Order Code KEN-582
4.0mm	25.0	10g	-4161K
4.5mm	25.0	10g	-4162K
5.0mm	25.0	10g	-4163K
5.5mm	25.0	10g	-4164K
6.0mm	25.0	10g	-4165K
7.0mm	25.0	20g	-4166K
8.0mm	25.0	20g	-4167K
9.0mm	25.0	20g	-4168K
10.0mm	25.0	20g	-4169K
11.0mm	25.0	30g	-4170K
12.0mm	25.0	30g	-4171K
13.0mm	25.0	30g	-4172K
14.0mm	25.0	40g	-4173K

Standard Length Sockets

Conform to **DIN3124**.

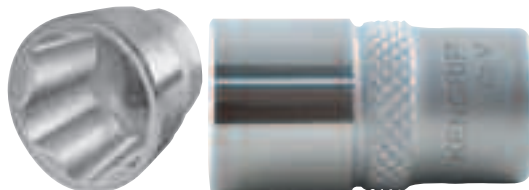

3/8" Square Drive

Size	Overall Length	Weight each	Order Code KEN-582
6.0mm	26.0	30g	-5832K
7.0mm	26.0	30g	-5833K
8.0mm	26.0	30g	-5834K
9.0mm	26.0	30g	-5835K
10.0mm	26.0	30g	-5836K
11.0mm	26.0	30g	-5837K
12.0mm	26.0	30g	-5838K
13.0mm	26.0	30g	-5839K
14.0mm	30.0	40g	-5840K
15.0mm	30.0	40g	-5841K
16.0mm	30.0	50g	-5842K
17.0mm	30.0	60g	-5843K
18.0mm	30.0	70g	-5844K
19.0mm	30.0	70g	-5845K
20.0mm	30.0	80g	-5846K
21.0mm	30.0	80g	-5847K
22.0mm	27.0	100g	-5848K

Standard Length Sockets

Conform to **DIN3124**.

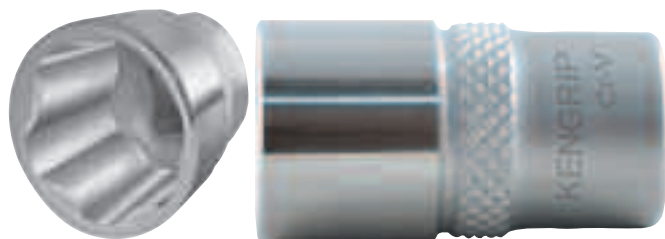

1/2" Square Drive

Size	Overall Length	Weight each	Order Code KEN-582
8.0mm	36.0	50g	-6871K
9.0mm	37.0	50g	-6872K
10.0mm	37.0	50g	-6873K
11.0mm	37.0	50g	-6874K
12.0mm	37.0	50g	-6875K
13.0mm	37.0	50g	-6876K
14.0mm	37.0	50g	-6877K
15.0mm	37.0	60g	-6878K
16.0mm	37.0	60g	-6879K
17.0mm	37.0	60g	-6880K
18.0mm	37.0	80g	-6881K
19.0mm	37.0	70g	-6882K
20.0mm	37.0	80g	-6883K
21.0mm	37.0	70g	-6884K
22.0mm	37.0	90g	-6885K
23.0mm	37.0	110g	-6886K
24.0mm	37.0	110g	-6887K
25.0mm	40.0	150g	-6888K
26.0mm	40.0	140g	-6889K
27.0mm	40.0	170g	-6890K
28.0mm	40.0	170g	-6891K
29.0mm	40.0	170g	-6892K
30.0mm	45.0	210g	-6893K
32.0mm	45.0	230g	-6895K
33.0mm	45.0	230g	-6898K
36.0mm	45.0	245g	-6899K

Deep Sockets

Conform to **DIN3124**.

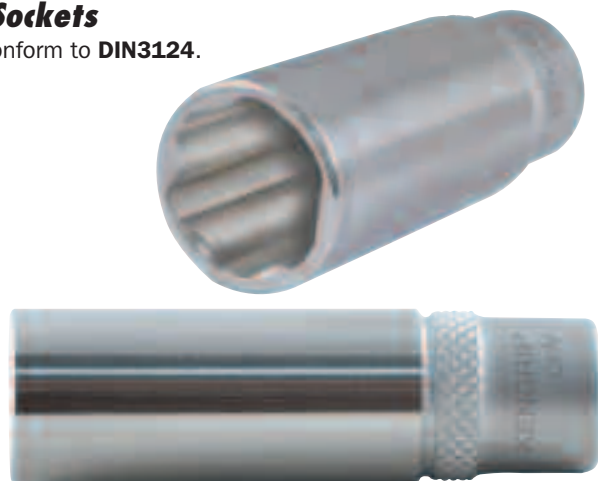

3/8" Square Drive

Size	Overall Length	Weight each	Order Code KEN-582
8.0mm	62.0	40g	-5849K
9.0mm	62.0	40g	-5850K
10.0mm	62.0	50g	-5851K
11.0mm	62.0	50g	-5852K
12.0mm	62.0	60g	-5853K
13.0mm	62.0	60g	-5854K
14.0mm	62.0	70g	-5855K
15.0mm	62.0	100g	-5856K
16.0mm	62.0	115g	-5857K
17.0mm	62.0	130g	-5858K
18.0mm	64.0	120g	-5859K
19.0mm	64.0	140g	-5860K
21.0mm	64.0	155g	-5861K
22.0mm	64.0	200g	-5862K

HAND TOOLS

KENNEDY PROFESSIONAL *Side Drive Socket Sets*



1/4" Square Drive 19 Piece Metric Set

Metric Ken-Grip® Sockets: 4, 4.5, 5, 5.5, 6, 7, 8, 9, 10, 11, 12, 13, 14mm.

Accessories: ratchet handle, spinner handle, sliding T-handle, flexi-drive 145mm, universal joint, extension bar 100mm.

**19
PIECES**

Number of Pieces	Weight each	Order Code
19	880g	-8800K



3/8" Square Drive 50 Piece Metric Set

Ken-Grip® Standard & Deep Sockets
Standard: 6, 7, 8, 9, 10, 11, 12, 13, 14, 15, 16, 17, 18, 19, 20, 21 and 22mm.
Deep: 10, 11, 12, 13, 14, 15, 17, 19 and 22mm.

Screwdriver Bits: Slotted 5, 5.5 and 6.5mm.
Crosspoint No.1, 2, 3, 4.
Sockets: 3, 4, 5, 6, 8 and 10mm.

Accessories: ratchet handle, sliding T-handle, spinner handle, swivel handle, universal joint, 125 and 250mm extensions, 250mm wobble extensions, 1/4" and 1/2" male adaptors, 1/4" socket bit coupler. Robust fitted case with security padlock hole and cushion grip handle.

**50
PIECES**

Number of Pieces	Weight each	Order Code
50	3.00kg	-8810K



1/2" Square Drive 30 Piece Metric Set

Ken-Grip®: 8, 9, 10, 11, 12, 13, 14, 15, 16, 17, 18, 19, 20, 21, 22, 23, 24, 25, 26, 27, 30 and 32mm.

Spark Plug Sockets: M10 and M14.

Accessories: quick release ratchet handle, sliding T-handle, universal joint, 75, 125 and 250mm extension bars. Robust fitted case with security padlock hole and cushion grip handle.

**30
PIECES**

Number of Pieces	Weight each	Order Code
30	5.50kg	-8820K

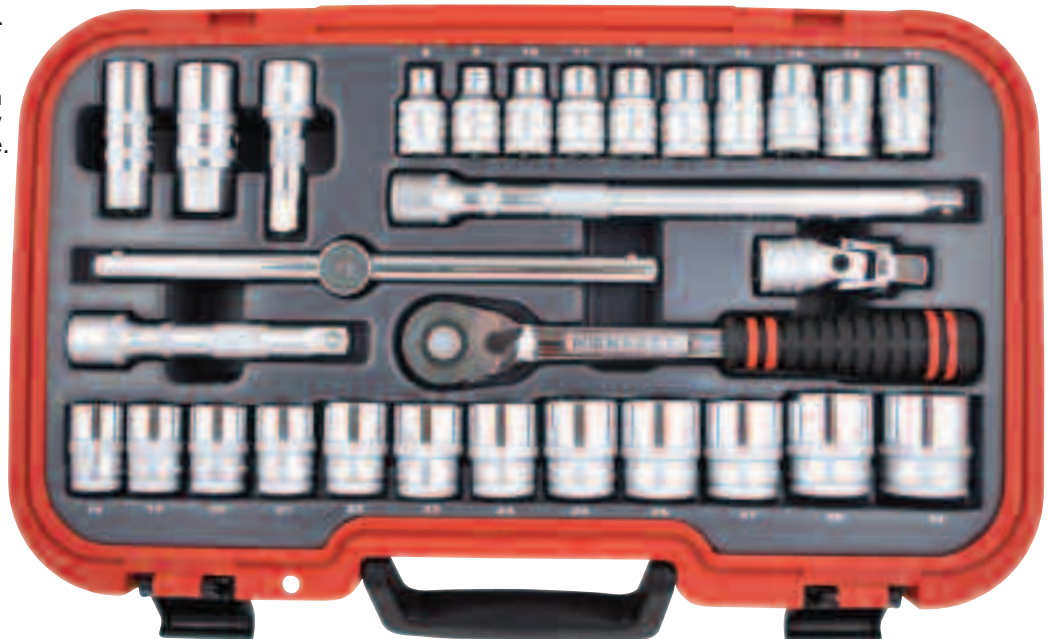

HAND TOOLS

KENNEDY PROFESSIONAL Push Through Steel Handles



1/4 Chrome - molybdenum with mirror polished finish. Push through square drive, needs only 3% movement to operate ratchet.



Type	Overall Length	Weight each	Order Code
Standard	125mm	120g	-4025K
Stubby	75mm	70g	-4028K

Disc Type Steel Handle

1/4 Standard wrench with high polished finish. Fitted with spring loaded ball bearing socket retainer. Manufactured from chrome vanadium steel.



Overall Length	Number of Teeth	Weight each	Order Code
140	20	170g	-4020K

Lever Reversible Rubber Handle

1/4 Chrome vanadium. Rubber grip, 72 tooth ratchet. With thumb lever for reversing without having to remove the socket or accessory. With quick release. A high quality wrench for the professional user.



Overall Length	Number of Teeth	Weight each	Order Code
140mm	72	90g	-4005K

Lever Reversible Steel Handle

1/4 Fully chromed all steel handle with thumb lever for reversing without having to remove the socket or accessory.



Overall Length	Number of Teeth	Weight each	Order Code
143mm	72	120g	-4015K

Spinner Handles

1/4 **Fixed Type:** Chrome vanadium blade with spring loaded ball bearing socket retainer. **Overall length:** 150mm.

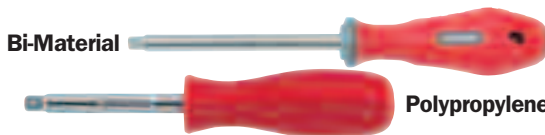

Handle Type	Weight each	Order Code
Bi-Material	110g	-4190K
Polypropylene	110g	-4200K

Extension Bars

1/4 Manufactured from high quality chrome vanadium with a fully polished finish. All with knurled 'finger grip'.

Standard



Overall Length	Weight each	Order Code
50mm	25g	-4060K
100mm	50g	-4080K
150mm	70g	-4100K
250mm	115g	-4120K

Flexible

Steel wire braid allows access into obstructed areas.

Overall Length	Weight each	Order Code
150mm	150g	-4140K

Wobble

In areas where clearance may be a problem the 'wobble' square drive can be used at an angle of up to 15°.



Overall Length	Weight each	Order Code
50mm	25g	-4070K
100mm	50g	-4090K
150mm	70g	-4110K
250mm	115g	-4130K

SENATOR QUALITY TOOLING Lever Reversible Rubber Handle



1/4 40 tooth chrome vanadium quick release ratchet with rubber grip, thumb lever for reversing without having to remove the socket or accessory.



Overall Length	Number of Teeth	Weight each	Order Code
145	40	120g	-4000K

KENNEDY PROFESSIONAL Ratchet Repair Kits

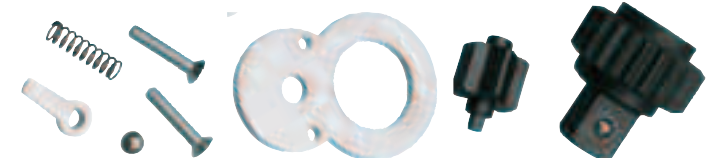

To suit Ratchet Number	Weight each	Order Code
KEN-582-4020K	30g	-4280K
KEN-582-4005K/4015K	30g	-4290K

Swivel Handle

1/4 The hinged link allows operation at varied angles to aid access in restricted areas. Knurled grip.



Overall Length	Weight each	Order Code
150mm	125g	-4180K

KENNEDY PROFESSIONAL Sliding 'T' Handle

1/4 Manufactured from high quality chrome vanadium with a fully polished finish. The sliding bar will give many options for leverage within a given space.

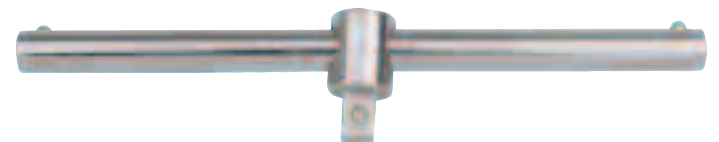

Overall Length	Weight each	Order Code
105mm	50g	-4040K

SOCKETS & ACCESSORIES - 1/4" SQUARE DRIVE

KENNEDY PROFESSIONAL Bi-Hexagon Sockets

1/4" Ideal for assembly and servicing of small precision mechanisms associated with electrical, electronic, ignition and refrigeration work. All bi-hexagon unless stated.

1/4" Double knurl feature gives a high grip which is essential for a quick tool change when your hands are greasy/oily. The 12 point bi-hexagon side drive design will give a higher torque than normal sockets. Manufactured from chrome vanadium, fully chrome plated with a mirror finish and aluminium-free to ensure non-sparking. Chamfered leading edge ensures easy fastener location.



Size (mm)	Overall Length	Weight each	Order Code KEN-582
Metric			
4.0	25mm	10g	-4300K
4.5	25mm	10g	-4310K
5.0	25mm	10g	-4320K
5.5	25mm	10g	-4330K
6.0	25mm	10g	-4340K
7.0	25mm	20g	-4350K
8.0	25mm	20g	-4360K
9.0	25mm	20g	-4370K
10.0	25mm	20g	-4380K
11.0	25mm	30g	-4390K
12.0	25mm	30g	-4400K
13.0	25mm	30g	-4410K
14.0	25mm	40g	-4420K

Size (mm)	Overall Length	Weight each	Order Code KEN-582
Metric (Single Hex)			
4.0	25mm	10g	-4540K
5.0	25mm	10g	-4542K
5.5	25mm	10g	-4543K
6.0	25mm	10g	-4544K
7.0	25mm	20g	-4545K
8.0	25mm	20g	-4546K
9.0	25mm	20g	-4547K
10.0	25mm	20g	-4548K
11.0	25mm	30g	-4549K
12.0	25mm	30g	-4550K
13.0	25mm	30g	-4551K
14.0	25mm	40g	-4552K

Size (mm)	Overall Length	Weight each	Order Code KEN-582
Metric (Deep)			
4.0	50mm	10g	-4670K
4.5	50mm	10g	-4671K
5.0	50mm	10g	-4672K
5.5	50mm	10g	-4673K
6.0	50mm	10g	-4674K
7.0	50mm	20g	-4675K
8.0	50mm	20g	-4676K
9.0	50mm	20g	-4677K
10.0	50mm	20g	-4678K
11.0	50mm	30g	-4679K
12.0	50mm	30g	-4680K
13.0	50mm	30g	-4681K
14.0	50mm	40g	-4682K

Size (mm)	Overall Length	Weight each	Order Code KEN-582
Metric (Single Hex Deep)			
6.0	50mm	10g	-4566K
7.0	50mm	10g	-4567K
8.0	50mm	10g	-4568K
9.5	50mm	10g	-4569K
10.0	50mm	10g	-4570K
11.0	50mm	20g	-4571K
12.0	50mm	20g	-4572K
13.0	50mm	20g	-4573K
14.0	50mm	40g	-4574K

Universal Joint

1/4" Hinged through 180° in both directions. Knurled for extra grip.

Drive male x female: 1/4" x 1/4".



Overall Length	Weight each	Order Code KEN-582
40mm	30g	-4160K

Adaptors/Converters

1/4" Chrome vanadium.

Hex Bit Adaptor

Converts square drive tooling to use hexagon bits.



Square Drive x Hex	Overall Length	Weight each	Order Code KEN-582
1/4" x 1/4"	25mm		-4230K

Screwdriver Bits

1/4" Manufactured from high quality chrome vanadium, fully polished finish. Conform to DIN.

Overall length: 37mm.

Bit length: 19mm.



Type	Size (mm)	Order Code KEN-582
Slotted	4.0mm	-4700K
	5.5mm	-4710K
	7.0mm	-4730K
Cross Point	No.1	-4750K
	No.2	-4760K
	No.3	-4770K
	No.4	-4780K
Hexagon	3.0mm	-4790K
	4.0mm	-4800K
	5.0mm	-4810K
	6.0mm	-4820K
	8.0mm	-4830K
	1/8"	-4840K
	5/32"	-4850K
	3/16"	-4860K
	7/32"	-4870K
	1/4"	-4880K
Torx	5/16"	-4890K
	T6	-4685K
	T7	-4686K
	T8	-4687K
	T9	-4688K
	T10	-4689K
	T15	-4690K
	T20	-4691K
	T25	-4692K
	T27	-4693K
T30	-4694K	
T40	-4695K	

Double Ended Lug

For connecting two female square drives



Drive Female x Male	Overall Length	Weight each	Order Code KEN-582
1/4" x 1/4"	25mm		-4240K

Drive Converter

For using a combination of square drive sockets in one application.



Drive Female x Male	Overall Length	Weight each	Order Code KEN-582
1/4" x 3/8"	27mm		-4220K
3/8" x 1/4"	37mm		-5180K

HAND TOOLS

GROUP 582 SOCKETS & ACCESSORIES - 3/8" SQUARE DRIVE

SENATOR *Lever Reversible Rubber Handle*

3/8 With thumb lever for reversing without having to remove the socket or accessory. Highly polished chrome vanadium with rubber grip.



Overall Length	Number of Teeth	Weight each	Order Code
200mm	40	345g	SEN-582 -4940K

KENNEDY *Disc Type Steel Handle*

3/8 Basic wrench with high polished finish. Fitted with spring loaded ball bearing socket retainer.



Overall Length	Number of Teeth	Weight each	Order Code
200mm	42	380g	KEN-582 -4900K

Lever Reversible Rubber Handle

3/8 Chrome vanadium. Rubber grip, 72 tooth ratchet. With thumb lever for reversing without having to remove the socket or accessory. With quick release. A high quality wrench for the professional user.



Overall Length	Number of Teeth	Weight each	Order Code
200mm	72	215g	KEN-582 -4942K

KENNEDY *Swivel Handles*

3/8 The hinged link allows operation at varied angles to aid access in restricted areas.



Grip	Overall Length	Weight each	Order Code
Steel	225mm	310g	-5060K
Rubber	225mm	225g	-5160K

Heavy Duty American Pattern



Grip	Overall Length	Weight each	Order Code
American	225mm	310g	KEN-582 -5065K
Components			
Replacement Knuckle			-5068K

YAMOTO *Quick Release Ratchet Handle*

3/8 With thumb lever for reversing without having to remove the socket or accessory. Highly polished chrome vanadium with rubber grip.



Overall Length	Number of Teeth	Weight each	Order Code
200mm	72	345g	YMT-582 -4942K

Push Through Rubber Handle

3/8 A very economic wrench with a one way ratchet. Push through square drive allows left and right hand operation.

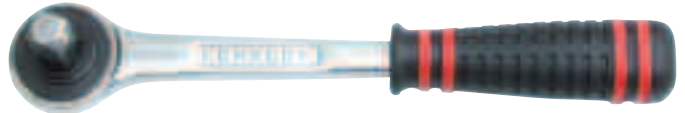

Overall Length	Number of Teeth	Weight each	Order Code
200mm	41	205g	KEN-582 -4930K

Clutch Type Drive Push Through Steel Handles

3/8 Chrome - molybdenum with mirror polished finish. Clutch type drive action Push through square drive, needs only 3% movement to operate ratchet.

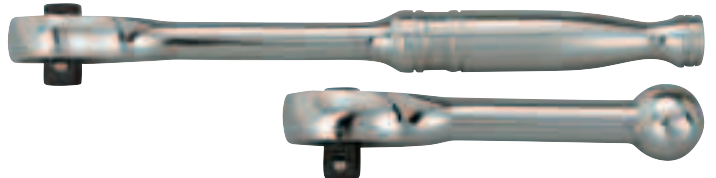

Type	Overall Length	Weight each	Order Code
Standard	180mm	220g	KEN-582 -4945K
Stubby	105mm	120g	-4948K

Lever Reversible Steel Handle

3/8 Fully chromed all steel handle with thumb lever for reversing without having to remove the socket or accessory.



Overall Length	Number of Teeth	Weight each	Order Code
200mm	72	205g	KEN-582 -4932K

Ratchet Repair Kits



To suit Ratchet Number	Weight each	Order Code
KEN-582-4900K	70g	-5220K
KEN-582-4932/4942K	70g	-5215K
KEN-582-4940K	70g	-5235K

YAMOTO *Swivel Handle*

3/8 Chrome finish. American style handle.



Overall Length	Weight each	Order Code
225mm	310g	YMT-582 -5060K

HAND TOOLS

KENNEDY PROFESSIONAL Extension Bars



3/8 Extensions
Manufactured from high quality chrome vanadium with a fully polished finish. All with knurled 'finger grip'.

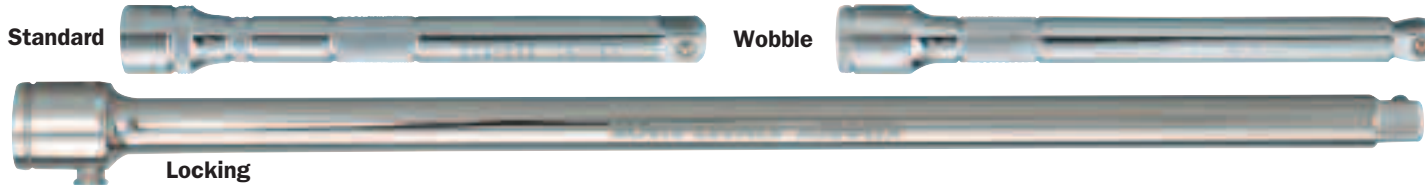

Standard

Overall Length	Weight each	Order Code KEN-582
75mm	80g	-4960K
125mm	130g	-4980K
150mm	150g	-5000K
250mm	280g	-5020K
300mm	340g	-5050K
450mm	430g	-5070K

Locking
A lever at the ratchet end of the extension pushes down a rod inside the bar which locks out the socket retaining ball, securing the socket to the bar. Ideal for use where there is a risk of leaving a socket in a recess.

Overall Length	Weight each	Order Code KEN-582
300mm	15g	-5150K

Wobble
In areas where clearance may be a problem the 'wobble' square drive can be used at an angle of up to 15°.

Overall Length	Weight each	Order Code KEN-582
75mm	65g	-5110K
150mm	120g	-5120K
250mm	260g	-5140K

YAMOTO Composite Ratchet Handle

3/8 With reverse lever, push button quick release. Offset handle to help eliminate knuckle scrapes. 72-tooth gear drive for maximum power and chrome vanadium core for strength.

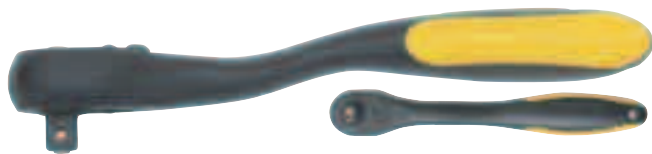

Overall Length	Number of Teeth	Weight each	Order Code YMT-582
200mm	72	235g	-7510K

Extensions

3/8 Chrome finish.

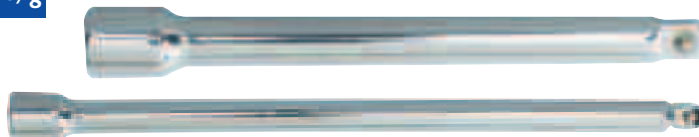

Type	Overall Length (mm)	Weight each	Order Code YMT-582
Standard	75	75g	-4960K
Standard	150	145g	-5000K
Wobble	250	235g	-5140K

Spinner Handle Fixed Type

3/8

Overall Length	Weight each	Order Code YMT-582
150mm	240g	-5100K

Sliding 'T' Handle

3/8

Overall Length	Weight each	Order Code YMT-582
165mm	185g	-4920K

Universal Joint

3/8 High polished chrome finish. Hinged through 180° in both directions.



Drive Male x Female	Overall Length	Weight each	Order Code YMT-582
3/8" x 3/8"	50mm	60g	-5040K

Spinner Handle Fixed Type

3/8 Chrome vanadium steel blade, polypropylene handle and spring loaded bearing socket retainer.



Overall Length	Weight each	Order Code KEN-582
210mm	240g	-5100K

Sliding 'T' Handle

3/8 Made from high quality chrome vanadium with a fully polished finish. The sliding bar gives many options for leverage within any space.

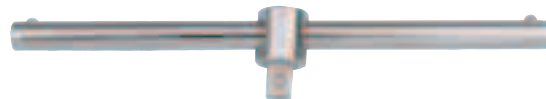

Overall Length	Weight each	Order Code KEN-582
165mm	185g	-4920K

Speed Braces

3/8 Manufactured from high quality chrome vanadium, fully polished finish. Ideal for nut spinning.

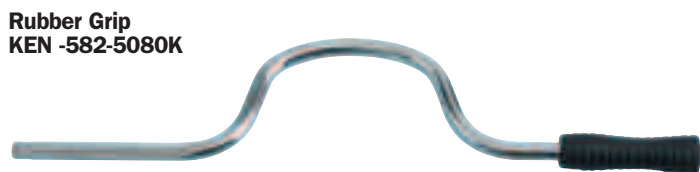

Grip	Overall Length	Weight each	Order Code KEN-582
American Pattern	425mm	500g	-5090K
Rubber Grip	470mm	410g	-5030K
	400mm	470g	-5080K

KENNEDY PROFESSIONAL Universal Joint

3/8 Hinged through 180° in both directions. Knurled for extra grip.

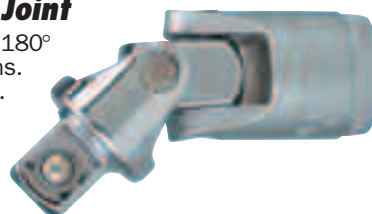

Drive Male x Female	Overall Length	Weight each	Order Code KEN-582
3/8" x 3/8"	50mm	60g	-5040K

HAND TOOLS

Socket Styles

Used in automotive and aerospace. The weight to strength ratio ensures the reliability and accessibility that is so important in this type of production environment.



Bi-Hexagon Sockets

12 point – side drive design gives a higher torque than normal sockets, grip worn nuts and will not round off existing nuts. All have a ball-retaining groove on each face of the square drive, which ensures a positive fit with accessories. Require only a one-twelfth turn to engage the next point of the socket.

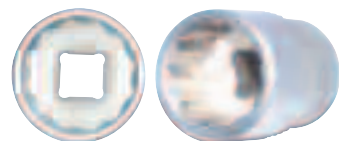

Single-Hexagon Sockets

6 point - Offer a more positive location, particularly on worn or rounded nuts, but require a one-sixth turn to engage the next point of the socket.

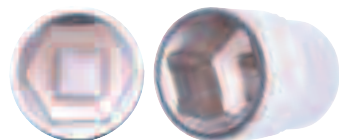

TX Sockets

Chrome vanadium. For use with male headed TX fasteners commonly found in the automotive industry. 29mm overall length and each weighing 45g.



Size	Order Code KEN-582
E6	-5960K
E8	-5962K
E10	-5964K
E12	-5966K
E14	-5968K
E16	-5970K

Bi-Hexagon Standard Length Sockets



**KENNEDY
PROFESSIONAL**

**YAMOTO
INDUSTRIAL SOCKET SETS**

Type	Size	Overall Length	Weight each
Metric	6mm	26	30g
	7mm	26	30g
	8mm	26	30g
	9mm	26	30g
	10mm	26	30g
	11mm	26	30g
	12mm	26	30g
	13mm	26	30g
	14mm	30	40g
	15mm	30	40g
	16mm	30	50g
	17mm	30	60g
AF	18mm	30	70g
	19mm	30	70g
	20mm	30	80g
	21mm	30	80g
	22mm	27	100g
	1/4"	27	30g
	5/16"	27	30g
	11/32"	27	30g
	3/8"	27	30g
	7/16"	27	30g
	1/2"	27	30g
	9/16"	27	40g
5/8"	27	50g	
11/16"	30	60g	
3/4"	25	70g	
13/16"	27	80g	
7/8"	27	10g	
1/8"	27	35g	
3/16"	27	45g	
1/4"	30	45g	
5/16"	30	45g	
3/8"	30	45g	
7/16"	30	85g	
1/2"	30	120g	

Order Code KEN-582
-5240K
-5250K
-5260K
-5270K
-5280K
-5290K
-5300K
-5310K
-5320K
-5330K
-5340K
-5350K
-5360K
-5370K
-5380K
-5390K
-5400K
-5430K
-5440K
-5450K
-5460K
-5470K
-5480K
-5490K
-5500K
-5510K
-5520K
-5530K
-5540K
-5580K
-5590K
-5600K
-5610K
-5620K
-5630K
-5640K

Order Code YMT-582
-5240K
-5250K
-5260K
-5270K
-5280K
-5290K
-5300K
-5310K
-5320K
-5330K
-5340K
-5350K
-5360K
-5370K
-5380K
-5390K
-5400K
-5430K
-5440K
-5450K
-5460K
-5470K
-5480K
-5490K
-5500K
-5510K
-5520K
-5530K
-5540K
-
-
-
-
-
-

Deep Sockets



Type	Size	Overall Length	Weight each
Metric	8mm	62	40g
	9mm	62	40g
	10mm	62	50g
	11mm	62	50g
	12mm	62	60g
	13mm	62	60g
	14mm	62	70g
	15mm	62	100g
	16mm	62	115g
	17mm	62	130g
	18mm	64	120g
	19mm	64	140g
AF	21mm	64	155g
	22mm	64	200g
	3/8"	63	45g
	7/16"	63	50g
	1/2"	63	60g
	9/16"	63	60g
	5/8"	65	110g
	11/16"	65	120g
	3/4"	65	135g
	13/16"	65	160g

Order Code KEN-582
-5700K
-5710K
-5720K
-5730K
-5740K
-5750K
-5760K
-5770K
-5780K
-5790K
-5800K
-5810K
-5820K
-5830K
-5870K
-5880K
-5890K
-5900K
-5910K
-5920K
-5930K
-5940K

Order Code YMT-582
-
-
-5720K
-5730K
-5740K
-5750K
-5760K
-5770K
-
-5790K
-
-5810K
-
-5830K
-5870K
-5880K
-5890K
-5900K
-5910K
-5920K
-5930K
-5940K

Single-Hexagon Standard Length



Type	Size	Overall Length	Weight each	Order Code KEN-582
Metric	6mm	26	30g	-5544K
	7mm	26	30g	-5555K
	8mm	26	30g	-5556K
	9mm	26	30g	-5557K
	10mm	26	30g	-5558K
	11mm	26	30g	-5559K
	12mm	26	30g	-5560K
	13mm	26	30g	-5561K
	14mm	30	40g	-5562K
	15mm	30	40g	-5563K
	16mm	30	50g	-5564K
	17mm	30	60g	-5565K
Single Hex	18mm	30	70g	-5566K
	19mm	30	70g	-5567K

SOCKETS & ACCESSORIES - 3/8" SQUARE DRIVE

KENNEDY PROFESSIONAL

Double Lug



3/8" Chrome vanadium.
For connecting two female square drives. 25mm long.



Drive Male x Male	Weight each	Order Code
3/8" x 3/8"	10g	-5170K

Female/Male Converters

3/8" Chrome vanadium.
For using a combination of square drive socketry in the same application.



Drive Female x Male	Weight each	Order Code
3/8" x 1/4"	20g	-5180K
3/8" x 1/2"	40g	-5190K
1/2" x 3/8"	50g	-6700K

Hex Bit Adaptor

3/8" Chrome vanadium.
For converting square drive tooling to use hexagon bits.



Drive x Hex	Overall Length	Weight each	Order Code
3/8" x 1/4"	30mm	30g	-5200K

Spark Plug Sockets

3/8" Designed for insertion and removal of the spark plug. The neoprene insert helps retain and protect the insulation from accidental damage.



Size (Plug)	Overall Length	Weight each	Order Code
M10	65mm	110g	-5670K
M12	65mm	110g	-5680K
M14	68mm	140g	-5660K

YAMOTO INDUSTRIAL SOCKET SETS

Spark Plug Sockets



3/8" For insertion and removal of spark plugs. Neoprene insert helps retain the spark plug and protect the insulation material from damage.



Size (Plug)	Overall Length	Weight each	Order Code
M10	65mm	110g	-5670K
M14	68mm	140g	-5660K

Hex Bit Adaptor

3/8" Chrome vanadium.
For converting square drive tooling to use hexagon bits.



Drive x Hex	Overall Length	Weight each	Order Code
3/8" x 1/4"	30mm	15g	-5200K

Screwdriver Bit Sockets

Often used in the automotive and aerospace industries. The weight to strength ratio ensures the reliability and accessibility that is important in this type of environment. Made from chrome vanadium steel, fully chrome plated with an aluminium free mirror finish. All have ball retaining grooves. Conform to **DIN standards**.



KENNEDY PROFESSIONAL

YAMOTO INDUSTRIAL SOCKET SETS

Size	Bit Lgth (mm)	Overall Lgth (mm)	Weight each
Hexagon			
3mm	20	50	25g
4mm	20	50	30g
5mm	20	50	30g
6mm	20	50	35g
8mm	20	50	45g
10mm	20	50	55g
1/8"	20	50	25g
5/32"	20	50	30g
3/16"	20	50	30g
7/32"	20	50	35g
1/4"	20	50	40g
5/16"	20	50	45g
3/8"	20	50	55g
Crosspoint			
No 1	20	50	50g
No 2	20	50	50g
No 3	20	50	55g
No 4	20	50	55g
PZ			
No 1	20	50	50g
No 2	20	50	50g
No 3	20	50	55g
Slotted			
3/16"	20	50	50g
7/32"	20	50	50g
1/4"	20	50	55g
TX			
T6	20	50	50g
T7	20	50	50g
T8	20	50	50g
T9	20	50	50g
T10	20	50	50g
T15	20	50	50g
T20	20	50	55g
T25	20	50	50g
T27	20	50	55g
T30	20	50	55g
T40	20	50	55g
T45	20	50	55g
T50	20	50	55g

Order Code **KEN-582**

Order Code **YMT-582**

-6000K
-6010K
-6020K
-6030K
-6040K
-6050K
-6080K
-6090K
-6100K
-6110K
-6120K
-6130K
-6140K

-6000K
-6010K
-6020K
-6030K
-6040K
-6050K
-
-
-
-
-
-
-

-6201K
-6202K
-6203K
-6204K

-6201K
-6202K
-6203K
-

-6211K
-6212K
-6213K

-
-
-

-6222K
-6223K
-6224K

-6222K
-
-6224K

-6231K
-6232K
-6233K
-6234K
-6235K
-6236K
-6237K
-6238K
-6239K
-6241K
-6242K
-6243K
-6244K

-
-
-
-
-6235K
-6236K
-6237K
-6238K
-
-6241K
-6242K
-
-6244K

KENNEDY PROFESSIONAL

Long Screwdriver Bit Sockets & Socket Bit Sets



Ideal for accessing deep seated bolts that have been fitted knurled bodies for extra grip. Made from S2 chrome vanadium. Supplied on storage rail.

Hexagon



6 Piece Set Contents:
4, 5, 6, 7, 8, 10mm.

6 PIECES

TX



6 Piece Set Contents:
T20, T25, T30, T40 T45 and T50

Bit Sets

Description	Weight each	Order Code
Hexagon 6 Piece Set	310g	-6324K
TX 6 Piece Set	410g	-6340K

Individual Bits - Hexagon

Size	Overall Length	Weight each	Order Code
4mm	100mm	40g	-6314K
5mm	100mm	40g	-6315K
6mm	100mm	45g	-6316K
7mm	100mm	45g	-6317K
8mm	100mm	55g	-6318K
10mm	100mm	65g	-6320K

Individual Bits - TX

Size	Overall Length	Weight each	Order Code
T20	95mm	65g	-6330K
T25	95mm	65g	-6331K
T30	95mm	65g	-6332K
T40	95mm	65g	-6334K
T45	95mm	65g	-6335K
T50	95mm	65g	-6336K

GROUP 582 SOCKETS & ACCESSORIES - 1/2" SQUARE DRIVE

1/2" DRIVE: The most popular drive size used in the service and maintenance industries. This popularity is due to its strength and robust nature.

KENNEDY PROFESSIONAL Lever Reversible Rubber Handle

1/2" Chrome vanadium. Rubber grip, 72 tooth ratchet. With thumb lever for reversing without having to remove the socket or accessory. With quick release. A high quality wrench for the professional user.



Overall Length	Number of Teeth	Weight each	Order Code
240mm	72	430	KEN-582 -6422K

Push Through Rubber Handle

1/2" A very economic wrench with a one way ratchet. Push through square drive allows left and right hand operation.

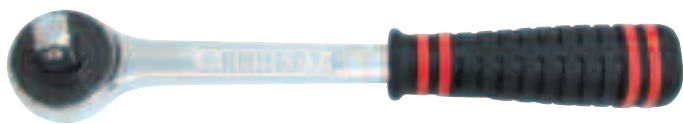

Overall Length	Number of Teeth	Weight each	Order Code
270mm	30	500g	KEN-582 -6430K

Lever Reversible Steel Handle

1/2" Fully chromed all steel handle with thumb lever for reversing without having to remove the socket or accessory.



Overall Length	Number of Teeth	Weight each	Order Code
250mm	72	510g	KEN-582 -6412K

Lever Reversible Steel Handle Flexi-Joint

1/2" Fully chromed lever type. All steel handle. The hinged joint gives additional capability in areas of restricted access.

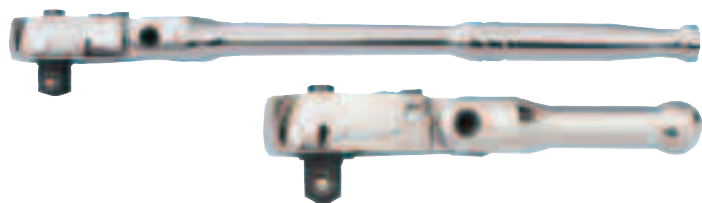

Type	Overall Length	Weight each	Order Code
Standard	420	860g	KEN-582 -6370K
Stubby	198	110g	KEN-582 -6375K

YAMOTO INDUSTRIAL SOCKET SETS Universal Joint

1/2" Hinged through 180° in both directions. Knurled for extra grip.



Drive M x F	Overall Length	Weight each	Order Code
1/2" x 1/2"	75mm	155g	YMT-582 -6580K

KENNEDY Ratchet Repair Kits



To suit Ratchet Number	Order Code
KEN-582-6400K	-6740K
KEN-582-6412K/-6422K	-6725K
KEN-582-6380K/-6390K	-6745K

Universal Joint

1/2" Hinged through 180° in both directions. Knurled for extra grip.



Drive M x F	Overall Length	Weight each	Order Code
1/2" x 1/2"	75mm	155g	KEN-582 -6580K

Push Through Steel Handle - Gearless

1/2" Chrome - molybdenum with mirror polished finish. Push through square drive, needs only 3% movement to operate gearless ratchet.



Overall Length	Weight each	Order Code
250mm	470g	KEN-582 -6435K

Disc Type Steel Handle

1/2" Basic wrench with high polished finish. Fitted with spring loaded ball bearing socket retainer.



Product Number	Number of Teeth	Weight each	Order Code
245mm	44	655g	KEN-582 -6400K

YAMOTO INDUSTRIAL SOCKET SETS Quick Release Ratchet Handle

1/2" With thumb lever for reversing without having to remove the socket or accessory. Highly polished chrome vanadium with rubber grip.



Overall Length	Number of Teeth	Weight each	Order Code
250mm	72	510g	YMT-582 -6412K

Composite Ratchet Handle

1/2" Quality composite reversible ratchet handle with reverse lever, push button quick release and an offset handle to help eliminate knuckle scrapes. Manufactured from composite material making it very light yet still very hard wearing. 72-tooth gear drive for maximum power and chrome vanadium core for strength.



Overall Length	Number of Teeth	Weight each	Order Code
250mm	72	435g	YMT-582 -7512K

SENATOR QUALITY TOOLING Lever Reversible Rubber Handle

1/2" With thumb lever for reversing without having to remove the socket or accessory. Highly polished chrome vanadium with rubber grip.



Overall Length	Number of Teeth	Weight each	Order Code
245mm	44	640g	SEN-582 -6400K

HAND TOOLS

SOCKETS & ACCESSORIES - 1/2" SQUARE DRIVE

KENNEDY PROFESSIONAL Speed Braces

1/2 Rubber grip, for fast nut spinning. Manufactured from high quality chrome vanadium, fully polished finish. Ideal for nut spinning.



Handle Type	Overall Length	Weight each	Order Code KEN-582
Rubber Grip	400mm	470g	-6560K
Steel Grip	425mm	510g	-6600K

Extension Bars

1/2 Manufactured from high quality chrome vanadium with a fully polished finish. All with knurled 'finger grip'.

Standard



Overall Length	Weight each	Order Code KEN-582
75mm	140g	-6460K
125mm	225g	-6480K
250mm	440g	-6500K
375mm	630g	-6520K
450mm	735g	-6530K

Wobble

In areas where clearance may be a problem the 'wobble' square drive can be used at an angle of up to 15°.



Overall Length	Weight each	Order Code KEN-582
75mm	65g	-6630K
125mm	120g	-6640K
250mm	260g	-6660K

Locking

A lever at the ratchet end of the extension pushes down a rod inside the bar which locks out the socket retaining ball, securing the socket to the bar. Ideal for use where there is a risk of leaving a socket in a recess.



Overall Length	Weight each	Order Code KEN-582
375mm	65g	-6670K

Sliding 'T' Handle

1/2 Manufactured from high quality chrome vanadium with a fully polished finish. The sliding bar will give many options for leverage within a given space.

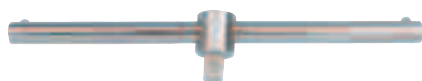

Overall Length	Weight each	Order Code KEN-582
250mm	360g	-6440K

YAMOTO INDUSTRIAL SOCKET SETS Sliding 'T' Handle

1/2 Manufactured from high quality chrome vanadium with a fully polished finish. The sliding bar will give many options for leverage within a given space.



Overall Length	Order Code YMT-582
250mm	-6370K

Extension Bars

1/2 Chrome finish.



Overall Length	Weight each	Order Code YMT-582
75mm	125g	-6460K
125mm	195g	-6480K
250mm	385g	-6500K

KENNEDY PROFESSIONAL Swivel Handles

1/2 The hinged link allows operation at varied angles to aid access in restricted areas.



Grip	Overall Length	Weight each	Order Code KEN-582
Rubber	300mm	645g	-6570K
American	375mm	540g	-6540K
American	450mm	830g	-6550K

Grip	Overall Length	Weight each	Order Code KEN-582
American	450mm	1099g	-6545K
American	600mm	1376g	-6555K

Service Parts

Replacement Knuckle	-6548K
---------------------	--------

1/2 Flexi-Ring End Sockets

Made from polished chrome vanadium. These tough flexi-ring end sockets are designed to allow access over long studs and for awkwardly positioned nuts and bolts. Swivels through 220°.

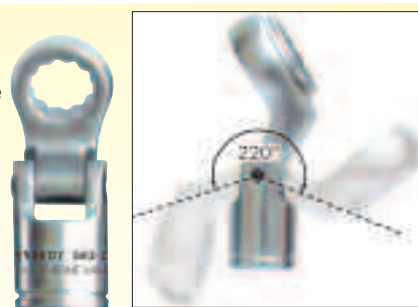

Type	Size	Overall Length	Weight each	Order Code KEN-582
Metric	13mm	70mm	124g	-1180K
	14mm	70mm	123g	-1181K
	15mm	70mm	121g	-1182K
	16mm	70mm	119g	-1183K
	17mm	77mm	158g	-1184K
	19mm	77mm	152g	-1185K
	22mm	82mm	193g	-1186K
	24mm	86mm	213g	-1187K

8 Piece Metric Set Contents:

13, 14, 15, 16, 17, 19, 22, and 24mm. Supplied with a sturdy hanging rail.



Number of Pieces	Contents	Weight each	Order Code KEN-582
8	As above	1.3kg	-1190K

Offset Fixed Handle

1/2 Knurled grip. Chrome vanadium. Fixed wrench for applications requiring rigid set up.



Overall Length	Weight each	Order Code KEN-582
200mm	255g	-6590K

YAMOTO INDUSTRIAL SOCKET SETS Swivel Handles

1/2 With hinged link and rubber grip.



Overall Length	Weight each	Order Code YMT-582
300mm	645g	-6570K
380mm	770g	-6575K

HAND TOOLS

GROUP 582 SOCKETS & ACCESSORIES - 1/2" SQUARE DRIVE

Bi-Hexagon Standard Length Sockets



KENNEDY PROFESSIONAL

YAMOTO INDUSTRIAL SOCKET SETS

Type	Size	Overall Length	Weight each
Metric	8mm	36	50g
	9mm	37	50g
	10mm	37	50g
	11mm	37	50g
	12mm	37	50g
	13mm	37	50g
	14mm	37	50g
	15mm	37	60g
	16mm	37	60g
	17mm	37	60g
	18mm	37	80g
	19mm	37	70g
	20mm	37	80g
	21mm	37	70g
	22mm	37	90g
	23mm	37	110g
	24mm	37	110g
	25mm	40	150g
	26mm	40	140g
	27mm	40	170g
	28mm	40	170g
	29mm	40	170g
	30mm	45	210g
	32mm	45	230g
	33mm	45	230g
36mm	45	245g	
AF	5/16"	37	50g
	3/8"	37	50g
	7/16"	37	50g
	1/2"	37	50g
	9/16"	37	50g
	19/32"	37	60g
	5/8"	37	60g
	11/16"	37	60g
	3/4"	37	70g
	13/16"	37	80g
	7/8"	40	90g
	15/16"	40	110g
	1"	40	130g
	1 1/16"	40	160g
	1 1/8"	40	170g
	1 3/16"	45	200g
	1 1/4"	45	230g
	1/8"	37	50g
	3/16"	37	50g
	1/4"	37	50g
	5/16"	37	60g
	3/8"	37	50g
	7/16"	37	70g
	1/2"	40	90g
	9/16"	40	140g
5/8"	40	170g	
11/16"	45	220g	
3/4"	45	220g	

Order Code	KEN-582
-6900K	
-6910K	
-6920K	
-6930K	
-6940K	
-6950K	
-6960K	
-6970K	
-6980K	
-6990K	
-7000K	
-7010K	
-7020K	
-7030K	
-7040K	
-7050K	
-7060K	
-7070K	
-7080K	
-7090K	
-7100K	
-7110K	
-7120K	
-7130K	
-7140K	
-7150K	
-7160K	
-7170K	
-7180K	
-7190K	
-7200K	
-7210K	
-7220K	
-7230K	
-7240K	
-7250K	
-7260K	
-7270K	
-7280K	
-7290K	
-7300K	
-7310K	
-7320K	
-7380K	
-7390K	
-7400K	
-7410K	
-7420K	
-7430K	
-7440K	
-7450K	
-7460K	
-7470K	
-7480K	

Order Code	YMT-582
-6900K	
-6910K	
-6920K	
-6930K	
-6940K	
-6950K	
-6960K	
-6970K	
-6980K	
-6990K	
-7000K	
-7010K	
-7020K	
-7030K	
-7040K	
-7050K	
-7060K	
-7070K	
-7080K	
-7090K	
-7100K	
-7110K	
-7120K	
-7130K	
-7140K	
-7150K	
-7160K	
-7170K	
-7180K	
-7190K	
-7200K	
-	
-7220K	
-7230K	
-7240K	
-7250K	
-7260K	
-7270K	
-7280K	
-7290K	
-7300K	
-	
-7320K	
-	
-7390K	
-7400K	
-7410K	
-7420K	
-7430K	
-7440K	
-7450K	
-7460K	
-	
-	

Socket Styles

Used in automotive and aerospace. The weight to strength ratio ensures the reliability and accessibility that is so important in this type of production environment.

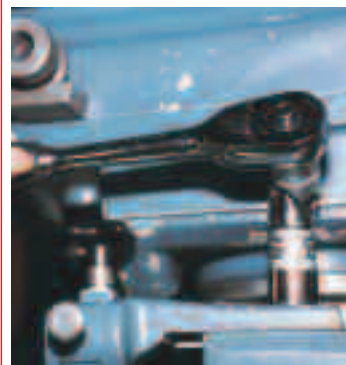

Bi-Hexagon Sockets

12 point - side drive design gives a higher torque than normal sockets, grip worn nuts and will not round off existing nuts. All have a ball-retaining groove on each face of the square drive, which ensures a positive fit with accessories. Require only a one-twelfth turn to engage the next point of the socket.



Single Hexagon Sockets

Six point - offer a more positive location, particularly on worn or rounded nuts, but require a one-sixth turn to engage the next point of the socket.

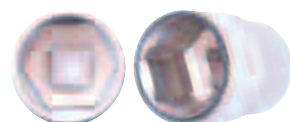

HAND TOOLS

KENNEDY Single Hexagon Standard Length Sockets

Six point - offer a more positive location, particularly on worn or rounded nuts, but require a one-sixth turn to engage the next point of the socket.



Type	Size	Overall Length	Weight each	Order Code
Metric	8mm	36	50g	-7346K
	9mm	37	50g	-7347K
	10mm	37	50g	-7348K
	11mm	37	50g	-7349K
	12mm	37	50g	-7350K
	13mm	37	50g	-7351K
	14mm	37	50g	-7352K
	15mm	37	60g	-7353K
	16mm	37	60g	-7354K
	17mm	37	60g	-7355K
	18mm	37	80g	-7356K
	19mm	37	70g	-7357K
	20mm	37	80g	-7358K
	21mm	37	70g	-7359K
	22mm	37	90g	-7360K
	23mm	37	110g	-7361K
	24mm	37	110g	-7362K
	26mm	40	140g	-7364K
	27mm	40	170g	-7365K
	28mm	40	170g	-7366K
	30mm	45	210g	-7368K
	32mm	45	230g	-7370K
	36mm	45	245g	-7374K

Bi-Hexagon Deep Sockets



Type	Size	Overall Length	Weight each	Order Code
Metric	10mm	77	100g	-7530K
	11mm	77	110g	-7540K
	12mm	77	110g	-7550K
	13mm	77	110g	-7560K
	14mm	77	110g	-7570K
	15mm	77	130g	-7580K
	16mm	77	120g	-7590K
	17mm	77	120g	-7600K
	18mm	77	150g	-7610K
	19mm	77	150g	-7620K
	21mm	77	160g	-7630K
	22mm	77	200g	-7640K
	24mm	77	220g	-7650K
	26mm	77	210g	-7660K
	27mm	77	250g	-7670K
	30mm	77	320g	-7680K
	32mm	77	340g	-7690K
	1/2"	77	110g	-7700K
	9/16"	77	100g	-7710K
	5/8"	77	120g	-7720K
	11/16"	77	110g	-7730K
	3/4"	77	140g	-7740K
	13/16"	77	160g	-7750K
	7/8"	77	190g	-7760K
	15/16"	77	220g	-7770K
1"	77	200g	-7780K	
1 1/8"	77	270g	-7790K	
1 1/4"	77	390g	-7800K	

SOCKETS & ACCESSORIES - 1/2" SQUARE DRIVE

KENNEDY PROFESSIONAL E-TX S Sockets

1/2 Chrome vanadium. For use with male headed TX fasteners commonly found in the automotive industry.



Size (Plug)	Overall Length	Weight each	Order Code KEN-582
E10	37mm	50g	-7485K
E12	37mm	55g	-7487K
E14	37mm	55g	-7489K
E16	37mm	55g	-7491K
E18	37mm	70g	-7493K
E20	37mm	90g	-7495K

Double Ended Lug

1/2 Chrome vanadium. For connecting two female square drives.



Drive Male x Male	Weight each	Order Code KEN-582
1/2" x 1/2"	35g	-6750K

Hex Bit Adaptors

1/2 Chrome vanadium. For converting square drive tooling to use hexagon bits.



Drive x Hex	Overall Length	Weight each	Order Code KEN-582
1/2" x 1/4"	35mm	40g	-6710K
1/2" x 5/16"	75mm	45g	-6720K

Female/Male Converters

1/2 Chrome vanadium. For using a combination of square drive socketry in the same application.

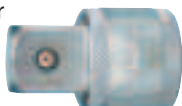

Drive Female x Male	Weight each	Order Code KEN-582
3/8" x 1/2"	40g	-5190K
1/2" x 3/4"	40g	-6680K
1/2" x 3/8"	50g	-6700K
3/4" x 1/2"	55g	-8120K

Spark Plug Sockets

1/2 Designed for insertion/ removal of spark plugs. The neoprene insert helps retain the spark plug and protect the insulation material from accidental damage. A unique double knurl gives a high grip essential for a quick tool change when hands are greasy.



Size (Plug)	Overall Length	Weight each	Order Code KEN-582
M10	65mm	85g	-7520K
M14	67mm	150g	-7500K

YAMOTO INDUSTRIAL SOCKET SETS Spark Plug Sockets

1/2 A neoprene insert helps retain the spark plug and protect the insulation material from accidental damage. A ball-retaining groove on each face ensures a positive fit with all accessories. Chamfered leading edge gives easy location.



Size (Plug)	Overall Length	Weight each	Order Code YMT-582
M10	65mm	85g	-7520K
M14	67mm	150g	-7500K

Screwdriver Bits

For insertion and removal of fasteners and fixings using 1/2" square drive tooling. Made from chrome vanadium steel, fully chrome plated with a mirror finish and aluminium-free to ensure non-sparking. All have ball retaining groove on each face of the square drive.

Conform to DIN standards.



Size	Bit Lgth (mm)	Overall Lgth (mm)	Weight each
⊖ Slotted			
8mm	20	55	80g
9mm	20	55	80g
10mm	20	55	90g
12mm	20	55	100g
14mm	20	55	130g
16mm	20	55	140g

Size	Bit Lgth (mm)	Overall Lgth (mm)	Weight each
⊙ Hexagon			
4mm	20	55	80g
5mm	20	55	70g
6mm	20	55	70g
7mm	20	55	70g
7mm	20	100	110g
8mm	20	55	70g
10mm	20	55	80g
12mm	20	55	100g
14mm	20	65	160g
17mm	20	70	205g
19mm	20	70	245g
3/16"	20	55	58g
1/4"	20	55	59g
5/16"	20	55	65g
3/8"	20	55	76g
1/2"	20	55	107g
9/16"	20	55	144g
3/4"	20	70	144g

Size	Bit Lgth (mm)	Overall Lgth (mm)	Weight each
⊕ Crosspoint			
No.2	20	55	55g
No.3	20	55	65g
No.4	20	55	70g

Size	Bit Lgth (mm)	Overall Lgth (mm)	Weight each
⊕ PZ			
No.2	17	55	70g
No.3	17	55	75g
No.4	17	55	80g

Size	Bit Lgth (mm)	Overall Lgth (mm)	Weight each
⊙ TX			
T20	20	58	60
T25	17	55	70
T27	17	55	70
T30	17	55	70
T40	17	55	70
T45	17	55	70
T50	17	55	70
T55	17	55	80
T60	17	55	105
T70	17	55	115

KENNEDY PROFESSIONAL

Order Code KEN-582
-7832K
-7834K
-
-7836K
-7838K
-7839K

YAMOTO INDUSTRIAL SOCKET SETS

Order Code YMT-582
-
-7809K
-7810K
-
-
-

KENNEDY PROFESSIONAL Spline Screwdriver Bit Set

6 Piece set containing short bits for bolts in tight areas and long bits for accessing deep seated, tight fitted spline bolts. Handy storage rail supplied.



6 PIECES

Description	Weight each	Order Code KEN-582
6 Piece Set (M6-M14)	665g	-7340K

Individual Bits

Size	Overall Length	Weight each	Order Code KEN-582
M6	55mm	58g	-7322K
M8	55mm	65g	-7324K
M8	100mm	84g	-7326K
M10	100mm	103g	-7328K
M12	100mm	136g	-7330K
M14	100mm	181g	-7332K

KENNEDY *Screwdriver Bit
Socket Sets*



1/2 Used most often in the automotive and aerospace industries. The weight to strength ratio ensures the reliability and accessibility that is so important in this type of production environment. For insertion and removal of fasteners and fixings using 1/2" square drive tooling. Unique knurled body gives extra grip which is essential for a quick tool change when your hands are greasy/oily.

Registered Design No. 2053516UK. Manufactured from chrome vanadium steel and are fully chrome plated with an aluminium free mirror finish. All have ball retaining groove on each face of the square drive. Conform to **DIN standards.**

Overall length: 55mm. **Bit length:** 20mm.

Engineers' 20 Piece Set Contents:

Crosspoint
No.2, 3 and 4.

Hexagon
4, 5, 6, 7, 8, 10, 12, 14, 17 and 19mm,
3/16", 1/4", 5/16", 3/8", 1/2", 9/16" and 3/4".

**20
PIECES**

Mechanic's 20 Piece Set Contents:

Slotted:
8, 9, 12, 14, and 16mm.

TX:
T20, T25, T27, T30, T40, T45, T50, T55 and T60.

Crosspoint:
No.2, 3 and 4.

PZ
No.2, 3 and 4.

**20
PIECES**



Number of Pieces	Contents	Weight each	Order Code
20	As above	1.90kg	-7880K

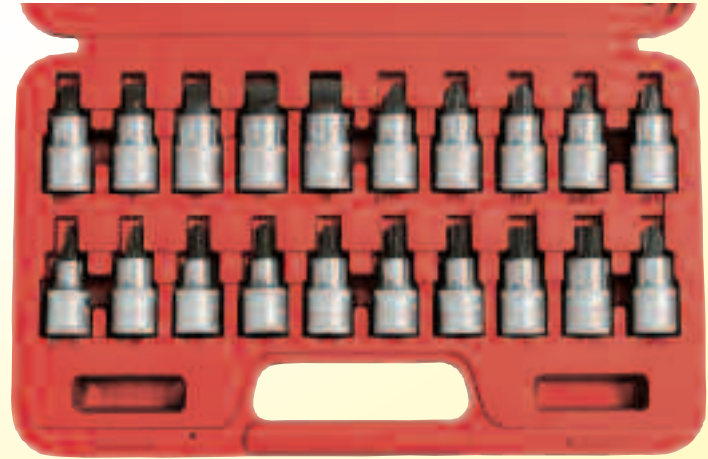

Number of Pieces	Contents	Weight each	Order Code
20	As above	2.50kg	-7890K

Hexagon Bit and Adaptor Set

1/2 1/2" square drive bit adaptor set contains a 10mm hex, 1/2" drive hand socket. Supplied in robust storage case.

Set Contents:

Hexagon
4, 5, 6, 8, 10 and 12mm.

**7
PIECES**



Number of Pieces	Contents	Weight each	Order Code
7	As above	2.55kg	-7900K

Stud Puller Set

1/2 Chrome vanadium clamping rollers grip worn or rounded fixings by compressing onto the fixing as the socket is turned, applying pressure to grip, turn and remove. Unscrews left and right hand threads.

Set Contents:
6mm, 8mm, 10mm, 12mm.

**4
PIECES**



Number of Pieces	Contents	Weight each	Order Code
4	As above	835g	-9480K

Stud Extractor

1/2 Manufactured from chrome alloy steel with a bright nickel and chrome finish. The locking wheel has a black oxidised finish. To use, place the extractor over the stud, then fit any 1/2" square drive handle and turn. The locking wheel moves into place to grip the stud and then remove it. 58mm outside diameter x 65mm high.



Range (mm)	Weight each	Order Code
6 - 19	585g	-6760K

KENNEDY *Oil Filter Cap
Wrench Set*



Cap type filter wrenches manufactured from chrome vanadium with a satin finish. Use with 3/8" or 1/2" sq drive wrenches to remove paper cartridge style oil filters.

Contents: 24, 27, 30, 32, 36, 38mm & 1/2" - 3/8" adaptor.

**7
PIECES**



Diameter (mm)	Weight each	Order Code
60 - 140	430g	-1790K

SOCKETS & ACCESSORIES - 3/4" SQUARE DRIVE

3/4" DRIVE: A heavy duty range designed to cope with the demands of industrial, agricultural machinery and heavy plant, static or mobile.

KENNEDY PROFESSIONAL Swivel Handle

3/4" The hinged link allows operation at varied angles to aid access in restricted areas.



Grip	Overall Length	Weight each	Order Code KEN-582
Knurled	475mm	1.90kg	-8100K

Sliding 'T' Handle

3/4" Manufactured from high quality chrome vanadium with a fully polished finish. Sliding bar gives many options for leverage within a given space.

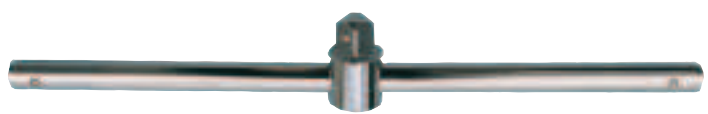

Overall Length	Weight each	Order Code KEN-582
450mm	1.35kg	-8040K

Offset Fixed Handle

3/4" Knurled grip. Chrome vanadium. Fixed wrench for applications requiring rigid set up.

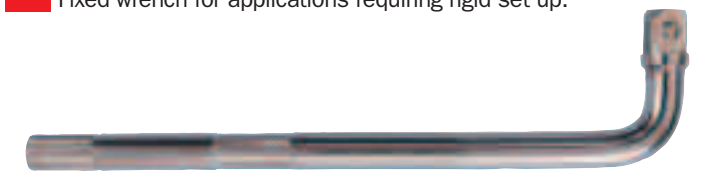

Overall Length	Weight each	Order Code KEN-582
300mm	255g	-8090K

Universal Joint

3/4" Knurled for extra grip.



Male x female: 3/4" x 3/4".

Overall Length	Order Code KEN-582
110mm	-8020K

Drive Converters

3/4" For using a combination of square sockets in one application.

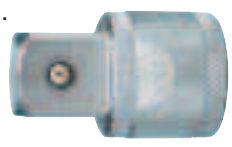

Drive F x M	Order Code KEN-582
3/4" x 1"	-8140K
1" x 3/4"	-9140K

Lever Reversible Steel Handle

3/4" Spring loaded ball bearing socket retainer. A high quality wrench for the professional user.



Overall Length	Number of Teeth	Weight each	Order Code KEN-582
500mm	24	2.40kg	-8000K

Disc Type Steel Handle

3/4" 50 tooth reversible ratchet.



Overall Length	Number of Teeth	Weight each	Order Code KEN-582
500mm	50	3.00kg	-8045K

Non-Reversible Rubber Grip Quick Release

3/4" 36 tooth ratchet.



Overall Length	Number of Teeth	Weight each	Order Code KEN-582
480mm	36	1.50kg	-8050K

Extension Bars

3/4" Manufactured from high quality chrome vanadium with a fully polished finish. All with knurled 'finger grip'.



Description	Overall Length	Weight each	Order Code KEN-582
Standard	100mm	432g	-8070K
	200mm	800g	-8060K
	400mm	1900g	-8080K

Double Ended Lug

3/4" Chrome vanadium. For use in push through ratchets and similar.



Male x male: 3/4" x 3/4".

Overall Length	Order Code KEN-582
60mm	-8130K

Ratchet Repair Kit

To suit ratchet number KEN-582- 8000K.



Weight each	Order Code KEN-582
550g	-8010K

Bi-Hexagon Sockets

3/4" A heavy duty range designed to cope with the demands of industrial agricultural machinery and heavy plant, static or mobile. All Kennedy Professional sockets have a unique double knurl to give a high grip essential for a quick tool change when hands are greasy. Manufactured from chrome vanadium and fully chrome plated with an aluminium free mirror finish. Chamfered leading edge ensures easy fastener location.

Registered Design No. 2053516UK.



Size	Overall Length	Weight each	Order Code KEN-582
Metric			
22	50mm	210g	-8150K
24	50mm	210g	-8170K
26	50mm	210g	-8190K
27	50mm	210g	-8200K
29	50mm	240g	-8220K
30	53mm	280g	-8230K
32	55mm	280g	-8240K
33	55mm	310g	-8250K
36	55mm	400g	-8260K
38	60mm	450g	-8280K
41	60mm	540g	-8300K
46	60mm	650g	-8320K
50	70mm	800g	-8340K
55	70mm	880g	-8360K
60	70mm	950g	-8380K

Size	Overall Length	Weight each	Order Code KEN-582
AF			
7/8"	50mm	140g	-8400K
15/16"	50mm	160g	-8410K
1"	50mm	180g	-8420K
1 1/16"	50mm	200g	-8430K
1 1/8"	50mm	240g	-8440K
1 3/16"	54mm	250g	-8450K
1 1/4"	54mm	260g	-8460K
1 5/16"	54mm	260g	-8470K
1 3/8"	57mm	280g	-8480K
1 7/16"	57mm	280g	-8490K
1 1/2"	60mm	290g	-8500K
1 5/8"	62mm	320g	-8520K
1 11/16"	65mm	320g	-8530K
1 3/4"	65mm	330g	-8540K
1 13/16"	65mm	350g	-8550K
1 7/8"	69mm	360g	-8560K
2"	71mm	380g	-8580K

PRODUCTS ARE ONLY AVAILABLE VIA YOUR DISTRIBUTOR

HAND TOOLS

1" Drive The ultimate for high torque hand applications. Designed to give strength and reliability under heavy loads. Used extensively in heavy plant, rail, shipyard and oil rig industries.



Lever Type Steel Handle with Extension



Sliding 'T'-Handle with Extension

Lever Type Steel Handle

1 Basic wrench with satin finish. Fitted with spring loaded ball bearing socket retainer.



Overall Length	Number of Teeth	Weight each	Order Code KEN-582
740mm	40	5.40kg	-8980K

Spares	Description	Order Code KEN-582
	Ratchet Repair Kit	-8990K

Sliding 'T' Handle

1 Manufactured from high quality chrome vanadium with a fully polished finish. The sliding bar will give many options for leverage within a given space.

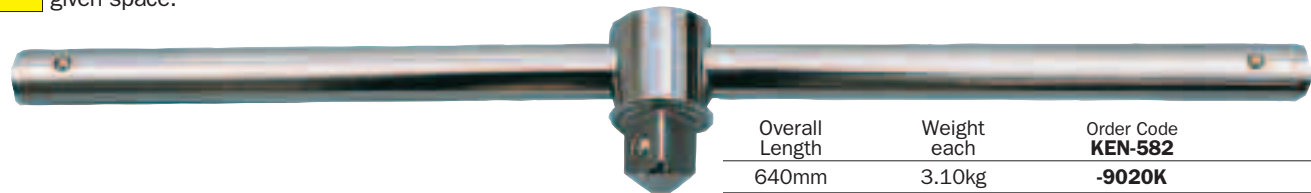

Overall Length	Weight each	Order Code KEN-582
640mm	3.10kg	-9020K

Extensions

1 Manufactured from high quality chrome vanadium with a fully polished finish. Knurled 'finger grip'.

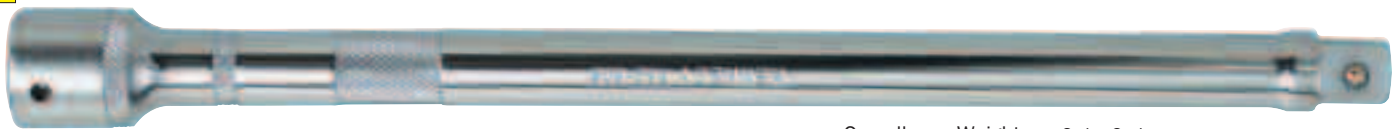

Description	Overall Length	Weight each	Order Code KEN-582
Standard	200mm	1.00kg	-9040K
	400mm	1.80kg	-9060K

Bi-Hexagon Standard Sockets

1 Bi-hexagon. (12 point). This range of 1" (25mm) series sockets is the ultimate for high torque hand applications. The Bi-hexagon design gives strength and reliability under heavy loads. Used extensively in heavy plant, rail, shipyard and oil rig industries. The 12 point bi-hexagon side drive design gives a higher torque than normal sockets. Made from chrome vanadium and fully chrome plated with an aluminium free mirror finish. Chamfered leading edge ensures easy fastener location.

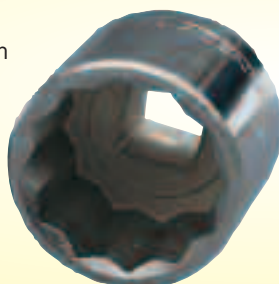

Type	Size	Overall Length	Weight each	Order Code KEN-582
	36mm	65	280g	-9200K
	41mm	65	330g	-9210K
	46mm	70	360g	-9220K
Metric	50mm	75	360g	-9230K
1	55mm	80	400g	-9240K
	60mm	85	420g	-9250K
	65mm	90	450g	-9260K
	70mm	100	480g	-9270K
	75mm	100	520g	-9280K
	80mm	110	550g	-9290K
AF	1 1/2"	70	300g	-9360K
1	2"	70	360g	-9400K
	2 1/4"	85	400g	-9420K
	2 3/8"	85	400g	-9430K



KENNEDY PROFESSIONAL **Socket Rail Trays**

Steel trays that comprise of 430mm rails with clips for retaining 1/4", 3/8" and 1/2" sq. drive sockets. Trays are fitted with carry handles and hanging holes for workshop storage.

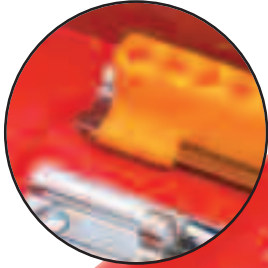

1/4" Hexagon screwdriver bit holders

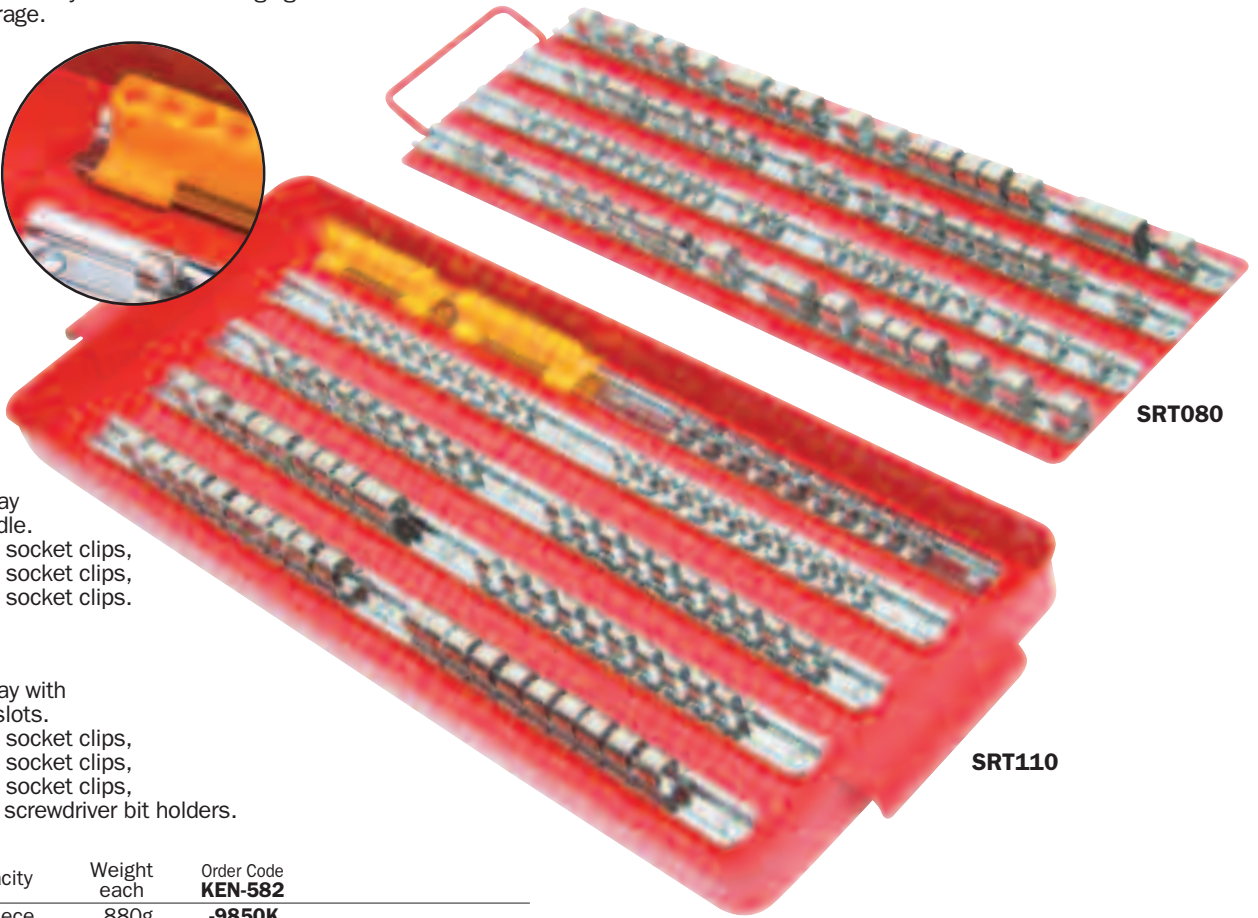

SRT080

SRT110

SRT080

Contents:

Powder coated tray with carrying handle.
30x 1/2" sq. drive socket clips,
30x 3/8" sq. drive socket clips,
20x 1/4" sq. drive socket clips.

SRT110

Contents:

Powder coated tray with integral hanging slots.
30x 1/2" sq. drive socket clips,
30x 3/8" sq. drive socket clips,
30x 1/4" sq. drive socket clips,
20x 1/4" hexagon screwdriver bit holders.

Product Number	Capacity	Weight each	Order Code
SRT080	80 Piece	880g	-9850K
SRT110	110 Piece	1.80kg	-9860K

KENNEDY **Socket Rails & Clips**

Made from steel, bright chrome plated and can be fixed or loose in a toolbox, or fitted to a bench or wall. Can be used with any size square drive socket.



Socket Rails

Overall Length	Weight per 10	Order Code
220mm	290g	-9820K
420mm	430g	-9840K

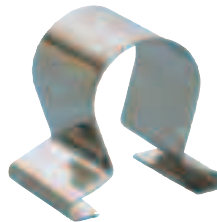

Socket Clips

Sq. Drive Size	Weight per 100	Order Code
1/4"	60g	-9880K
3/8"	90g	-9890K
1/2"	150g	-9900K

Socket Racks

Socket rails and socket clips combined together.

Sq. Drive Size	Overall Length	No of Clips	Weight each	Order Code
1/4"	420mm	15	70g	-9920K
	220mm	8	30g	-9930K
3/8"	420mm	15	70g	-9950K
	220mm	8	30g	-9960K
1/2"	420mm	15	70g	-9980K
	220mm	8	30g	-9990K



PRODUCTS ARE ONLY AVAILABLE VIA YOUR DISTRIBUTOR

GROUP 582 SOCKET SETS - MIXED DRIVE

SENATOR
QUALITY TOOLING

1/4" Drive Ideal for assembly and servicing of small precision mechanisms associated with electrical, electronic, ignition and refrigeration work.

3/8" Drive Used in the automotive and aerospace industries. The weight to strength ratio ensures the reliability and accessibility that is so important on this type of production. Sockets have a knurl feature to give a high grip which is essential for a quick tool change when your hands are greasy/oily. The 12 point bi-hexagon side drive design will give a higher torque than normal sockets, grip worn nuts and will not round off existing nuts. Manufactured from chrome vanadium and are fully chrome plated with an aluminium free mirror finish. Chamfered leading edge ensures easy fastener location. Sockets manufactured to: **ANSI B107.5M : 1987, ANSI B107.1 : 1978 & BS 4006 : 1992.**

Accessories manufactured to: **ANSI B107.10M : 1982 & BS 4006 : 1992.**



SDA100MAB - 100 Piece Metric, Inch & BA

**100
PIECES**

1/4" Drive Bi-Hex Sockets:

4, 4.5, 5, 5.5, 6, 7, 8, 9, 10, 11, 12, 13mm.
3/16", 7/32", 1/4", 9/32", 5/16", 11/32", 3/8", 7/16", 1/2" AF.
0, 2, 4, 6, 8 and 10BA.

Screwdriver Bits:

Slotted 3.5, 4.5, 5.5, 6mm.
Crosspoint No.1, No.2, No.3.
PZ No.1, No.2, No.3.
TX T15, T20, T25.

Hex 3, 4, 5, 6, 8, 10mm.
1/8", 5/32", 3/16", 7/32", 1/4", 5/16", 3/8" AF.

Accessories: 50, 75 and 150mm extension bars, ratchet handle, sliding T-handle, spinner handle, universal joint.

3/8" Drive Bi-Hex Sockets:

6, 7, 8, 9, 10, 11, 12, 13, 14, 15, 16, 17, 19 and 21mm.
1/4", 5/16", 3/8", 7/16", 1/2", 9/16", 5/8", 11/16" and 3/4" AF.

Deep Sockets: 10, 11, 12, 13 and 14mm
9/16", 5/8", 11/16" and 3/4" AF.

Spark Plug Sockets: M10 (16mm) and M14 (21mm).

Accessories: 75 and 150mm extension bars, flexible handle, ratchet handle, universal joint, sliding T-handle



HAND TOOLS

Number of Pieces	Weight each	Order Code
100	5.00kg	SEN-582 -0080K

SA40MA 40 Piece - Metric & Inch

**40
PIECES**

3/8" Drive Bi-Hex Sockets:

6, 7, 8, 9, 10, 11, 12, 13, 14, 15, 16, 17, 19 and 21mm.
1/4", 5/16", 3/8", 1/2", 9/16", 5/8", 7/16", 11/16" and 3/4" AF.

Deep Sockets: 10, 11, 12, 13 & 14mm.
9/16", 5/8", 11/16" and 3/4" AF.

Spark Plug Sockets: M10 (16mm) and M14 (21mm).

Accessories: Ratchet handle, sliding T-handle, swivel handle, universal joint. 75mm and 150mm extension bars.

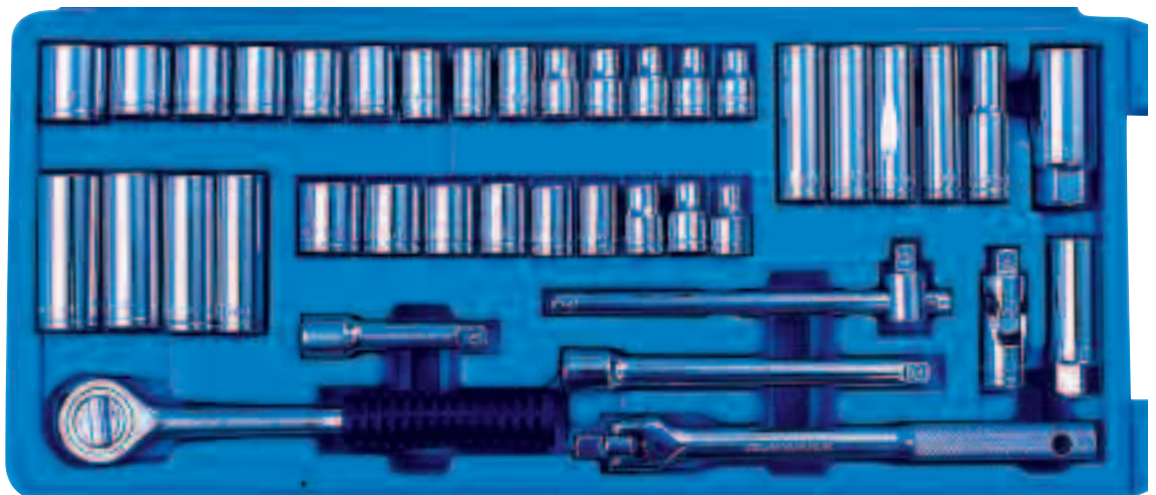

Number of Pieces	Weight each	Order Code
40	3.90kg	SEN-582 -0100K

HOME IMPROVER

PRODUCTS ARE ONLY AVAILABLE VIA YOUR DISTRIBUTOR

KENNEDY PROFESSIONAL *Side Drive Socket Sets*

The Ken-Grip® socket offers a new standard of performance with the ability to grip fasteners which are up to 95% rounded off. A unique patented socket design grips new, worn and rusted fasteners without damaging them further. Double knurl feature gives a high grip which is essential for quick tool change when hands are greasy or oily. Manufactured from chrome vanadium steel, the sockets and accessories are aluminium free, fully chrome plated for a corrosion resistant, easy clean finish. The set features an extensive selection of socket sizes for use across a wide range of fasteners.

KENGRIP®

Patented Design



Will grip new, worn and rusted fasteners without damaging them further



Will grip fasteners which are up to 95% rounded off

Will also fit a wide range of non-metric Hexagons, E-Torx® and Spline Drive Sizes.

1/4" Square Drive 19 Piece Metric Set

Metric Ken-Grip® Sockets: 4, 4.5, 5, 5.5, 6, 7, 8, 9, 10, 11, 12, 13, 14mm.

Accessories: ratchet handle, spinner handle, sliding T-handle, flexi-drive 145mm, universal joint, extension bar 100mm.

Number of Pieces	Weight each	Order Code
19	880g	-8800K

**19
PIECES**

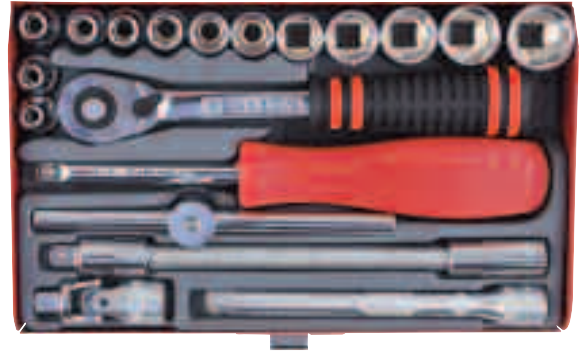

3/8" Square Drive 50 Piece Metric Set

Ken-Grip® Standard & Deep Sockets
Standard: 6, 7, 8, 9, 10, 11, 12, 13, 14, 15, 16, 17, 18, 19, 20, 21 and 22mm.
Deep: 10, 11, 12, 13, 14, 15, 17, 19 and 22mm.

Screwdriver Bits: Slotted 5, 5.5 and 6.5mm.
Crosspoint No.1, 2, 3, 4.

Sockets: 3, 4, 5, 6, 8 and 10mm.

Accessories: ratchet handle, sliding T-handle, spinner handle, swivel handle, universal joint, 125 and 250mm extensions, 250mm wobble extensions, 1/4" and 1/2" male adaptors, 1/4" socket bit coupler. Robust fitted case with security padlock hole and cushion grip handle.

**50
PIECES**

Number of Pieces	Weight each	Order Code
50	3.00kg	-8810K

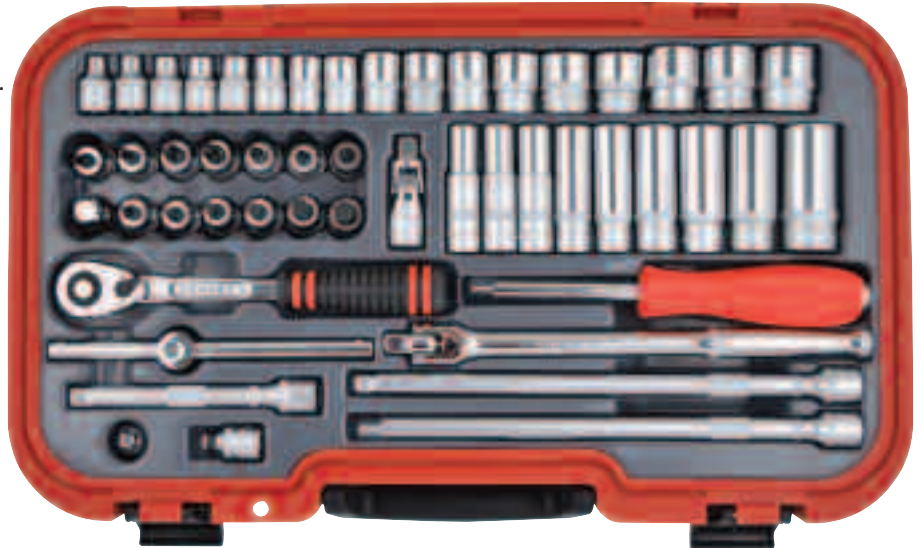

1/2" Square Drive 30 Piece Metric Set

Ken-Grip®: 8, 9, 10, 11, 12, 13, 14, 15, 16, 17, 18, 19, 20, 21, 22, 23, 24, 25, 26, 27, 30 and 32mm.

Spark Plug Sockets: M10 and M14.

Accessories: quick release ratchet handle, sliding T-handle, universal joint, 75, 125 and 250mm extension bars. Robust fitted case with security padlock hole and cushion grip handle.

**30
PIECES**

Number of Pieces	Weight each	Order Code
30	5.50kg	-8820K

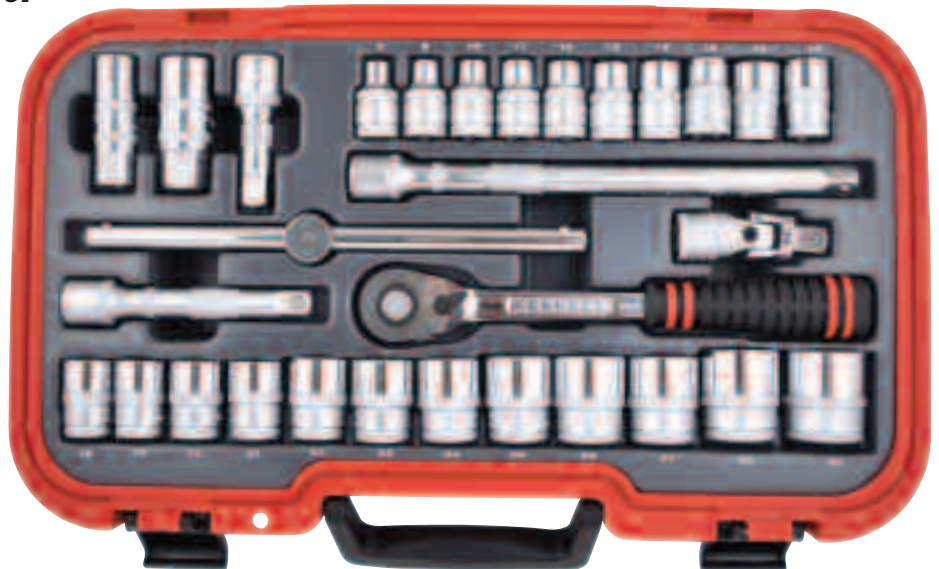

HAND TOOLS

GROUP 582 SOCKET SETS - 1/4" SQUARE DRIVE



1/4" Drive Ideal for assembly and servicing of small precision mechanisms associated with electrical, electronic, ignition and refrigeration work. Sockets have a knurl feature to give a high grip which is essential for a quick tool change when your hands are greasy/oily. The six point bi-hexagon side drive design will give a higher torque than normal sockets, grip worn nuts and will not round off existing nuts. Manufactured from chrome vanadium and are fully chrome plated with an aluminium free mirror finish. Chamfered leading edge ensures easy fastener location. Sockets made to: **ANSI B107.5M : 1987, ANSI B107.1 : 1978 & BS 4006 : 1992.** Accessories made to: **ANSI B107.10M : 1982 & BS 4006 : 1992.**



TS19M - 19 Piece Metric Socket Set

Metric Hex Sockets: 4, 4.5, 5, 5.5, 6, 7, 8, 9, 10, 11, 12, 13, 14mm.

Accessories: ratchet handle, spinner handle, sliding T-handle, flexi-drive 145mm, universal joint, extension bar 100mm.



Number of Pieces	Weight each	Order Code
19	880g	KEN-582 -4893K

TS29MA - 29 Piece Metric & Inch Socket Set

Metric Sockets: 4, 4.5, 5, 5.5, 6, 7, 8, 9, 10, 11, 12, 13, 14mm. **AF Sockets:** 3/16", 7/32", 1/4", 9/32", 5/16", 11/32", 3/8", 7/16", 1/2", 9/16".

Accessories: ratchet handle, spinner handle, sliding T-handle, flexi-drive 145mm, universal joint, extension bar 100mm.

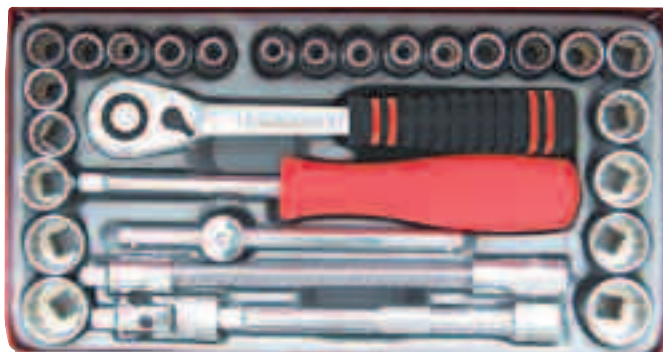

Number of Pieces	Weight each	Order Code
29	1.2kg	KEN-582 -4895K

51 Piece Metric/AF

TSD51MA

Standard & Deep Sockets

Standard Sockets (Metric): 4, 5, 5.5, 6, 7, 8, 9, 10, 11, 12, 13, 14mm.

Deep Sockets (Metric): 6, 7, 8, 9, 10, 11, 12, 13, 14mm.

Standard Sockets (AF): 3/16", 7/32", 1/4", 9/32", 5/16", 11/32", 3/8", 7/16", 1/2", 9/16".

Deep Sockets (AF): 3/16", 7/32", 1/4", 9/32", 5/16", 11/32", 3/8", 7/16", 1/2", 9/16".

Accessories: ratchet handle (rubber grip), 100mm sliding T-handle, 100 and 250mm extension bars, 50 and 150mm wobble extensions, universal joint, spinner handle, 150mm flexible extension, swivel handle rubber grip.

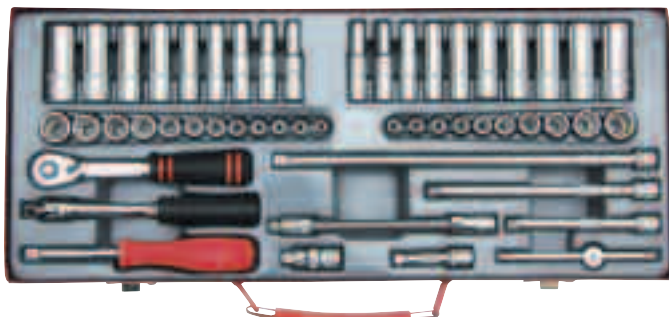

Number of Pieces	Weight each	Order Code
51	3.2kg	KEN-582 -4902K

SENATOR QUALITY TOOLING RSD43 - 43 Piece Metric & Inch

High quality chrome vanadium for garage, workshop and home maintenance.

Sockets: 6, 7, 8, 9, 10, 11, 12mm. 3/16", 1/4", 5/16", 11/32", 3/8", 7/16" and 1/2" AF.

Long Series (50mm) Bits: Slotted 4, 5, 6mm. **Crosspoint** No.1, No.2, No.3. **TX** T10, T15, T20, T25, T27, T30, T40, T45.

Short Series (25mm) Bits: **PZ** No.1, No.2. **Hex** 1.5, 2, 2.5, 3, 4, 5, 5.5 and 6mm.

Accessories: ratchet spinner handle, 150mm flexible extension bar, 100mm hex bit extension bar, 1/4" coupler, 50mm socket coupler.

HOME IMPROVER



Number of Pieces	Weight each	Order Code
43	1.10kg	SEN-582 -0040K

SD60MAB - 60 Piece Metric, Inch & BA

Sockets: 4, 4.5, 5, 5.5, 6, 7, 8, 9, 10, 11, 12 and 13mm. 3/16", 7/32", 1/4", 9/32", 5/16", 11/32", 3/8", 7/16" and 1/2" AF. 0, 2, 4, 6, 8 and 10BA.

Screwdriver Bits: Slotted 3.5, 4.5, 5.5, 6mm.

Crosspoint No.1, No.2 No.3. **PZ** No.1, No.2, No.3.

TX T15, T20 and T25. **Hex** 3, 4, 5, 6, 8 and 10mm. 1/8", 5/32", 3/16", 7/32", 1/4", 5/16", 3/8" AF.

Accessories: ratchet handle, sliding T-handle, spinner handle, universal joint. 50, 75 and 150mm extension bars,



Number of Pieces	Weight each	Order Code
60	1.50kg	SEN-582 -0060K

HAND TOOLS



1/4" Drive Ideal for assembly and servicing of small precision mechanisms associated with electrical, electronic, ignition and refrigeration work. Sockets have a knurl feature to give a high grip which is essential for a quick tool change when your hands are greasy/oily. The 12 point bi-hexagon side drive design will give a higher torque than normal sockets, grip worn nuts and will not round off existing nuts. Manufactured from chrome vanadium and are fully chrome plated with an aluminium free mirror finish. Chamfered leading edge ensures easy fastener location. Sockets manufactured to: **ANSI B107.5M : 1987, ANSI B107.1 : 1978 & BS 4006 : 1992.** Accessories manufactured to: **ANSI B107.10M : 1982 & BS 4006 : 1992.**

TSD46M - 46 Piece Metric Set

Standard & Deep Sockets with Screwdriver Bits

Sockets: 4, 4.5, 5, 5.5, 6, 7, 8, 9, 10, 11, 12, 13, 14mm.
Deep Sockets: 4, 4.5, 5, 5.5, 6, 7, 8, 9, 10, 11, 12, 13, 14mm.
Screwdriver Bits: Slotted 4, 5.5, 7mm.
Crosspoint No.1, No.2, No.3. **Hex** 3, 4, 5, 6, 8mm.
Accessories: sliding T-handle, ratchet handle, extension bar 50 and 150mm, wobble extension 100 and 250mm, universal joint, jointed swivel handle 150mm, spinner handle.

TS46MA - 46 Piece Metric & Inch

Standard Sockets with Screwdriver Bits

Sockets: 4, 4.5, 5, 5.5, 6, 7, 8, 9, 10, 11, 12, 13, 14mm.
AF Sockets: 3/16", 7/32", 1/4", 5/16", 11/32", 3/8", 7/16", 1/2".
Screwdriver Bits: Slotted 4, 5.5mm. **Crosspoint** No.2, No.3. **Hex** 3, 4, 5, 6, 8mm. **Hex** 1/8", 5/32", 3/16", 7/32", 1/4", 5/16" AF.
Accessories: sliding T-handle, ratchet handle, wobble extension 50 and 150mm, extension bars 100 and 250mm, universal joint, jointed swivel handle 150mm, flexible extension 150mm, spinner handle.

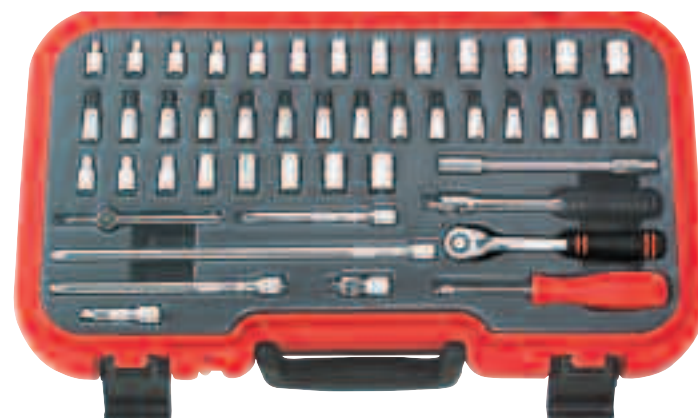

Number of Pieces	Weight each	Order Code
46	3.20kg	KEN-582 -4897K

Number of Pieces	Weight each	Order Code
46	3.00kg	KEN-582 -4898K

TSD82MA - 82 Piece Metric & Inch

Standard & Deep Sockets with Screwdriver Bits

Sockets: 4, 4.5, 5, 5.5, 6, 7, 8, 9, 10, 11, 12, 13, 14mm. 3/16", 7/32", 1/4", 5/16", 11/32", 3/8", 7/16", 1/2" AF. 0, 1, 2, 3, 4, 5, 6BA.
Deep Sockets: 4, 4.5, 5, 5.5, 6, 7, 8, 9, 10, 11, 12, 13, 14mm.
Screwdriver Bits: Slotted 4, 5.5, 7mm. **Crosspoint** No.1, No.2, No.3, No.4. **Hex** 3, 4, 5, 6, 8mm. 1/8", 5/32", 3/16", 7/32", 1/4", 5/16" AF. **TZ** T6, T7, T8, T9, T10, T15, T20, T25, T27, T30, T40.
Accessories: sliding T-handle, ratchet handle, 100, 150 and 250mm extension bars, 50 and 150mm wobble extension, 150mm flexible extension, square male adaptor 3/8", 150mm jointed swivel handle, spinner handle, universal joint.

MT50M - 50 Piece Metric

Standard Sockets:

4, 4.5, 5, 5.5, 6, 7, 8, 9, 10, 11, 12, 13mm.
Accessories: ratchet handle, sliding T-handle, 50, 150 and 250mm extension bars, 100mm wobble extension, 150mm flexible extension, universal joint, 150mm jointed swivel handle, spinner handle.
Sockets: 8, 9, 10, 11, 12, 13, 14, 15, 16, 17, 18, 19, 20, 21, 22, 23, 24, 27, 30, 32, 36mm.
Accessories: quick release ratchet handle, universal joint, sliding T-handle, 375mm swivel handle, 75 and 250mm extension bars, 150mm wobble extensions.

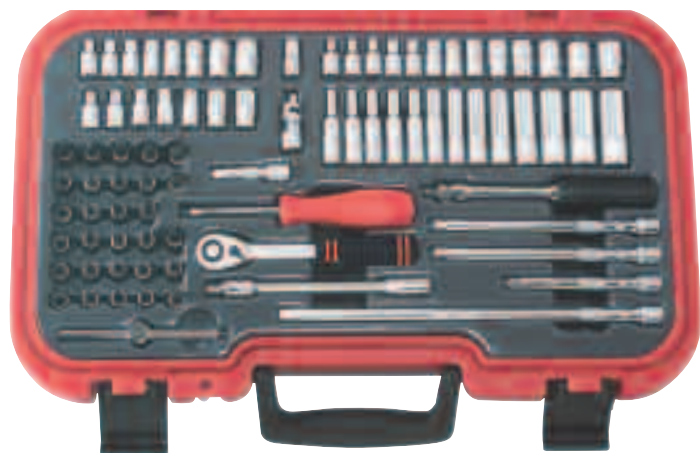

Number of Pieces	Weight each	Order Code
82	3.80kg	KEN-582 -4896K

Number of Pieces	Weight each	Order Code
50	8.10kg	KEN-582 -4899K

PRODUCTS ARE ONLY AVAILABLE VIA YOUR DISTRIBUTOR

HAND TOOLS

GROUP 582 SOCKETS SETS - 3/8" SQUARE DRIVE



3/8" Drive Used in the automotive and aerospace industries. The weight to strength ratio ensures the reliability and accessibility that is so important on this type of production. All Kennedy professional sockets have a double knurl feature to give a high grip which is essential for a quick tool change when your hands are greasy/oily. The 12 point bi-hexagon side drive design will give a higher torque than normal sockets, grip worn nuts and will not round off existing nuts. Manufactured from chrome vanadium and are fully chrome plated with an aluminium free mirror finish. Chamfered leading edge ensures easy fastener location. Sockets manufactured to: **ANSI B107.5M: 1987, ANSI B107.1: 1978 & BS 4006 : 1992.** Accessories manufactured to: **ANSI B107.10M : 1982 & BS 4006 : 1992.**



S30M - 30 Piece Metric with Screwdriver Bits

Sockets: 6, 7, 8, 9, 10, 11, 12, 13, 14, 15, 16, 17, 18, 19, 21 and 22mm.
Spark Plug Sockets: M10 and M14.

Screwdriver Bits: Slotted 5mm, 6mm. **Crosspoint** No.1, 2, 3, 4.

Accessories: ratchet handle, sliding T-handle, swivel handle, universal joint, 75mm extension bar, 150mm wobble extension, parts tray with magnetic insert. Robust fitted case with security padlock hole and cushion grip handle.



Number of Pieces	Weight each	Order Code
30	3.50kg	KEN-582 -6170K

Accessories

Description	Order Code
Locking Clasps (Pair)	KEN-567 -6000K

SD25MA - 25 Piece Metric & Inch

Bi-Hex Sockets Deep Sockets: 8, 9, 10, 11, 12, 13, 14, 15, 16, 17, 18, 19, 21, 22mm. 3/8", 7/16", 1/2", 9/16", 5/8", 11/16", 3/4" and 13/16" AF.

Accessories: swivel handle, sliding T-bar, 125mm extension. Parts tray with magnetic insert. Robust fitted case with security padlock hole and cushion grip handle.

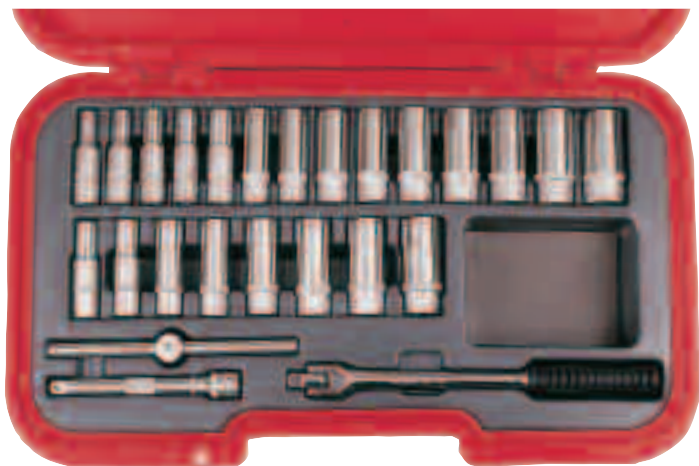

Number of Pieces	Weight each	Order Code
25	5.50kg	KEN-582 -6190K

Accessories

Description	Order Code
Locking Clasps (Pair)	KEN-567 -6000K

S40MA - 40 Piece Metric & Inch

Metric & Inch Sockets: 6, 7, 8, 9, 10, 11, 12, 13, 14, 15, 16, 17, 18, 19, 20, 21, 22mm. 1/4", 5/16", 11/32", 3/8", 7/16", 1/2", 9/16", 5/8", 11/16", 3/4", 13/16" and 7/8" AF.

Spark Plug Sockets: M10 and M14.

Accessories: ratchet handle, sliding T-handle, universal joint, 75 and 150mm extension bars, 150mm wobble extension, 1/4" and 1/2" male adaptors, 1/4" hexagon coupler. Robust fitted case with security padlock hole and cushion grip handle.



Number of Pieces	Weight each	Order Code
40	3.60kg	KEN-582 -6175K

Accessories

Description	Order Code
Locking Clasps (Pair)	KEN-567 -6000K

SSD50M - 50 Piece Metric with Screwdriver Bits

Standard & Deep Sockets
Standard: 6, 7, 8, 9, 10, 11, 12, 13, 14, 15, 16, 17, 18, 19, 20, 21 and 22mm.
Deep: 10, 11, 12, 13, 14, 15, 17, 19 and 22mm.

Screwdriver Bits: Slotted 5, 5.5 and 6.5mm. **Crosspoint** No.1, 2, 3, 4. **Hex** 3, 4, 5, 6, 8 and 10mm.

Accessories: ratchet handle, sliding T-handle, spinner handle, swivel handle, universal joint, 125 and 250mm extensions, 250mm wobble extensions, 1/4" and 1/2" male adaptors, 1/4" hex bit coupler. Robust fitted case with security padlock hole and cushion grip handle.

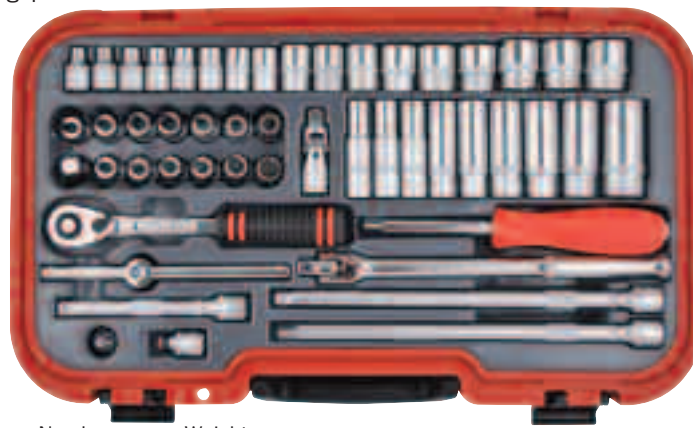

Number of Pieces	Weight each	Order Code
50	4.75kg	KEN-582 -6180K

Accessories

Description	Order Code
Locking Clasps (Pair)	KEN-567 -6000K

HAND TOOLS



SS90MAW - 90 Piece Metric, Inch & Whitworth with Screwdriver Bits

Sockets: 6, 7, 8, 9, 10, 11, 12, 13, 14, 15, 16, 17, 18, 19, 20, 21, 22mm.
 1/4", 5/16", 11/32", 3/8", 7/16", 1/2", 9/16", 5/8", 11/16", 3/4", 13/16" and 7/8" AF. 1/8", 3/16", 1/4", 5/16", 3/8", 7/16" and 1/2" Whit.

Screwdriver Bits:

Slotted 3/16", 7/32" and 1/4". **Crosspoint** No.1, 2, 3, 4. **PZ** No.1, No.2, No.3. **TX** T6, T7, T8, T9, T10, T15, T20, T25, T27, T30, T40, T45, T50. **Hex** 3, 4, 5, 6, 8, 10mm. 1/8", 5/32", 3/16", 7/32", 1/4", 5/16" and 3/8" AF.

Spark Plug Sockets: M10 and M14.

Accessories: ratchet handle, sliding T-handle, spinner handle, swivel handle, universal joint. 75, 125, 150, 250, 300 and 450mm extensions, 150 and 250mm wobble extensions, 1/4" and 1/2" male adaptors, 1/4" hexagon coupler. Robust fitted case with security padlock hole and cushion grip handle.

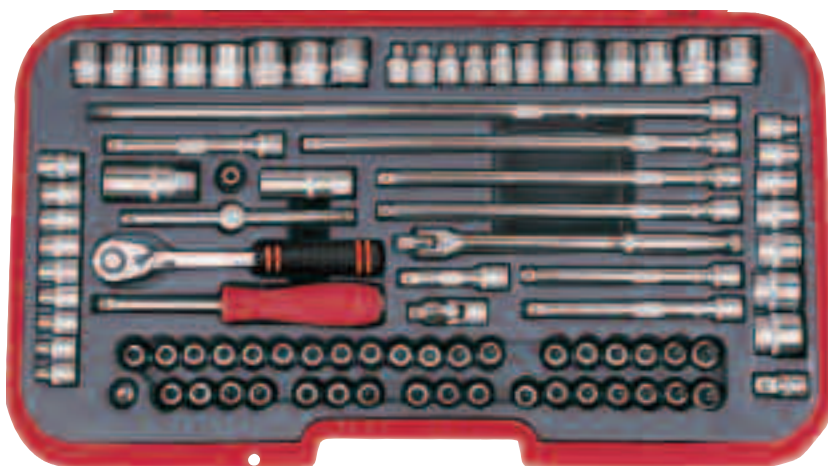

Number of Pieces	Weight each	Order Code	Accessories	Order Code
90	8.70kg	-6185K	Locking Clasps (pr)	-6000K



3/8" Square Drive Manufactured from industrial quality chrome vanadium steel with high polished corrosion resistant finish. The high strength to weight ratio ensures the reliability and accessibility that is necessary for use in the automotive, assembly, service and maintenance industries.

The bi-hexagonal design allows a higher torque to be applied and will not round off existing nuts. Sockets manufactured to: **ANSI B107.5M:1987**. Accessories manufactured to: **ANSI B107.10M:1982**.



55 Piece Metric Standard & Deep Socket Set with Screwdriver Bits

3/8" Drive Bi-Hex Sockets Standard & Deep Sockets:

Sockets: 6, 7, 8, 9, 10, 11, 12, 13, 14, 15, 16, 17, 18, 19, 20, 21, and 22mm.

Deep Sockets: 10, 11, 12, 13, 14, 15, 17, 19 and 22mm.

Spark Plug Sockets: M10 and M14.

Screwdriver Bits: Phillips No.1, 2, 3.

Slotted 5, 6mm.

TX T10, T15, T20, T30, T40, T50.

Hex 3, 4, 5, 6, 8, 10mm. Hex bit coupler.

Accessories: Lever type ratchet, sliding T-handle, swivel handle, spinner handle, universal joint, 150 and 300mm extension bars, 250mm wobble extension. Fitted case with cushioned handle, snap shut clasp and padlock hole.



Number of Pieces	Weight each	Order Code	Accessories	Order Code
55	6.00kg	-6180K	Replacement Case	-2870K

55 Piece Metric & Inch

3/8" Drive Bi-Hex Sockets Standard & Deep Sockets

Sockets: 6, 7, 8, 9, 10, 11, 12, 13, 14, 15, 16, 17, 18, 19, 20, 21 and 22mm.
 1/4", 5/16", 11/32", 3/8", 7/16", 1/2", 9/16", 5/8", 11/16", 3/4", 13/16", and 7/8" AF.

Deep Sockets: 10, 11, 12, 13, 14, 15, 17, 19, 22mm. 3/8", 7/16", 1/2", 9/16", 5/8", 11/16", 3/4" and 13/16" AF.

Spark Plug Sockets: M10 and M14.

Accessories: lever type ratchet, sliding T-handle, universal joint, 150 and 300mm extension bars, 250mm wobble extension, 1/4" hex bit coupler. Fitted case with cushioned handle, snap shut clasp and padlock hole.



Number of Pieces	Weight each	Order Code	Accessories	Order Code
55	5.70kg	-6200K	Replacement Case	-2880K

HAND TOOLS

GROUP 582 SOCKET SETS - 3/8" & 1/2" SQUARE DRIVE

YAMOTO
INDUSTRIAL SOCKET SETS

1/2" Square Drive Manufactured from industrial quality chrome vanadium steel with corrosion resistant high polish aluminium free mirror finish. The 12 point bi-hexagonal side drive sockets allow higher torques to be applied to nuts without damage and grip worn nuts. The strength and robust design of 1/2" drive make them suitable for the heavy use encountered in agriculture, service and maintenance industries. Sockets manufactured to: **ANSI B107.5M:1987**. Accessories manufactured to: **ANSI B107.10M:1982**.



30 Piece Metric

Sockets: 8, 9, 10, 11, 12, 13, 14, 15, 16, 17, 18, 19, 20, 21, 22, 23, 24, 25, 26, 27, 30 and 32mm.

Spark Plug Sockets: M14 and M10.

Accessories: quick release flick lever ratchet with rubber grip, T-handle uni-joint, 75, 125 and 250mm extension bars, robust fitted case with padlock hole and cushion grip handle.

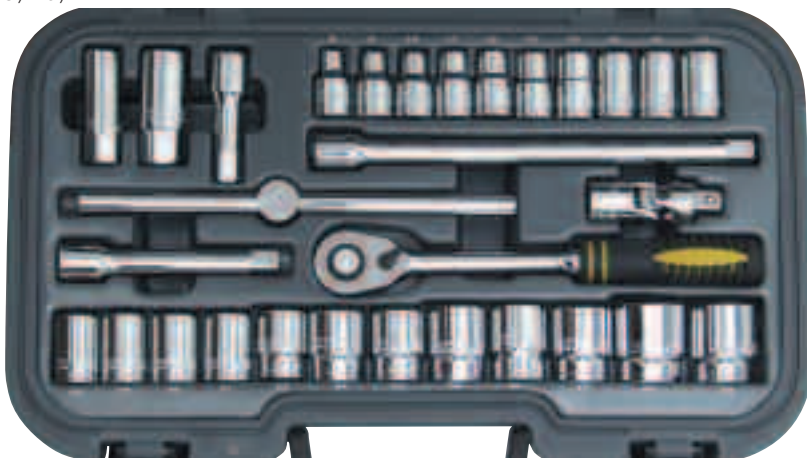

Number of Pieces	Weight each	Order Code
30	6.00kg	-7992K

Accessories	Order Code
Replacement Case	-2910K

50 Piece Metric

Sockets: 8, 9, 10, 11, 12, 13, 14, 15, 16, 17, 18, 19, 20, 21, 22, 23, 24, 25, 26, 27, 28, 29, 30, 32, 33 and 36mm.

Screwdriver Bits: Hex 4, 5, 6, 7, 8, 10, 12, 14, 17 and 19mm.

Phillips No.2, No.3, No.4.

Chrome Molybdenum Screwdriver Bits: 9 and 14mm chemically blacked.

Spark Plug Sockets: M14 and M10.

Accessories: black rubber ratchet handle, T-handle, swivel handle, universal joint, 75, 125 and 250mm extension bars. Robust fitted case with magnetic parts tray, padlock hole and cushion grip handle.



Number of Pieces	Weight each	Order Code
50	10.3kg	-7994K

Accessories	Order Code
Replacement Case	-2920K

HAND TOOLS

KENNEDY Oil Drain Plug Key Set

DPK017

A comprehensive set of quality 3/8" sq. drive oil drain plug keys with tommy bar. Made from satin finished chrome vanadium.

Contents: Male Square: 7mm, 8mm (5/16"), 9mm, (3/8"), 10mm, 11mm, 12mm and 13mm. Female Square: 10mm.

Male Hex: 8, 9, 10, 12, 14 and 17mm.

Male Triangular 10mm.

Tommy bar.



**17
PIECES**

Product Number	Number of Pieces	Order Code
DPK017	17	-1720K

Glow Plug Socket Set

GPS060

A comprehensive set of quality glow plug sockets with universal joints for use in awkward areas. Made from satin finished chrome vanadium with a neoprene insert to grip and protect the plug.

Contents: 8, 9, 10, 12, 14 and 16mm.



**6
PIECES**

Product Number	Number of Pieces	Order Code
GPS060	6	-1740K



Combined Socket & Wrench Tool Kit

The Senator 208 Piece Combined Socket and Wrench Tool Kit comes with a plastic storage case. **Contents:** 1/2" drive sockets: 13 - 32mm. Drive deep sockets: 16 to 22mm. E-Sockets: 20, 22, 24mm. Screwdriver bits: Hex 14mm, TX 70. Converters: 1/2" sq. male x 3/8" sq. female. Accessories: 125, 250mm extensions bars, 1/2" drive universal joint, T-bar, quick release offset bi-material ratchet handle. 3/8" drive sockets: 10 - 19mm. Deep sockets: 10 - 15mm. Spark plug sockets: 16, 18, 21mm. E-Sockets: 10 - 18mm. Screwdriver bits: Slotted 6 - 12. PZ No. 1, 2, 3. Crosspoint No.1, 2, 3, 4. Hex 6 - 12mm. TX 40 - 60. Tamper proof TX 40 - 60. Spline 5, 6, 8. Converters: 3/8" sq. female x 5/16" hex drive, 3/8" sq. female x 1/4" sq. male. Accessories: 75mm extension bar, universal joint, quick release offset bi-material ratchet handle. 1/4" drive sockets: 4 - 14mm. Deep sockets: 4 - 10mm. E-Sockets: 4 - 8mm. Screwdriver bits: Slotted 4 - 7mm. PZ No.0, 1, 2. Crosspoint No.0, 1, 2, TX 8 - 30. Tamper-proof TX 8 - 30. Hex 3 - 6mm. Converters: 1/4" sq. female x 1/4" hex drive. Accessories: 50, 100mm extension bars, universal joint, T-bar, nut spinner handle, quick release offset bi-material ratchet handle. Combination spanners: 8 - 19mm. Hex key wrenches: 1.5, 2.0, 2.5mm. Magnetic bit: 1/4" hex driver. Screwdriver bits: 1/4" hex driver. Converter: 2x 1/4" sq. male, Slotted 2x 3.5, 4mm 1x 5.5, 6.5, 8mm, PZ No.1, 2, 3, Crosspoint 2x No.0, 1, 2, 3, TX 10, 15, 20, 25, 27, 30, 40, Tri-Wing No.1, 2, 3, 4, Square 1, 2, 3, hex 2, 3, 4, 5, 6, 7mm.



**208
PIECES**

Number of Pieces	Weight each	Order Code
208	10.7kg	SEN-582 -9000K

SE24M - 24 Piece Metric

**24
PIECES**

Sockets: 10, 11, 12, 13, 14, 15, 16, 17, 18, 19, 20, 21, 22, 23, 24, 27, 30, and 32mm.

Accessories: ratchet handle, T-handle, speed brace, universal joint, 125 and 250mm extension bars.

SE24MA - 24 Piece Metric & Inch

HOME IMPROVER

As for SE24M except for:

Sockets: 10, 11, 12, 13, 14, 16, 17, 19, 20 and 22mm. 3/8", 7/16", 1/2", 9/16", 5/8", 3/4", 7/8" and 15/16" AF.

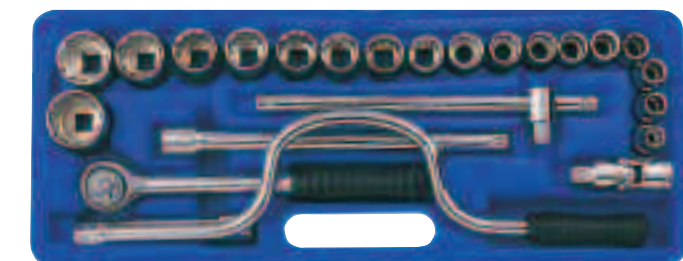

Model Number	Number of Pieces	Weight each	Order Code
SE24M	24	4.00kg	-0120K
SE24MA	24	4.00kg	-0160K

SE42MAW - 42 Piece Metric, Inch & Whitworth

Sockets: 10, 11, 12, 13, 14, 15, 17, 19, 20, 21, 22, 24 and 27mm. 3/8", 7/16", 1/2", 9/16", 5/8", 11/16", 3/4", 13/16", 7/8", 15/16", 1", 1 1/16", 1 1/4" AF. 1/8", 3/16", 1/4", 5/16", 3/8", 7/16", 1/2", 9/16" and 5/8" BSW.

Spark Plug Socket: M14 (21mm).

Accessories: ratchet, T-handle, brace, universal joint, 125 and 250mm extension bars.

**42
PIECES**



Number of Pieces	Weight each	Order Code
42	6.15kg	SEN-582 -0180K

KENNEDY Oxygen 'EGO', 'O2', 'Lambda' Sensor Socket Set

**3
PIECES**

Three piece universal set. Essential for servicing today's computer-controlled vehicle systems. Easily removes exhaust gas oxygen sensors (known as 'EGO', 'O2' or 'Lambda' sensors), vacuum switches and pressure switches. Also suitable for diesel injectors found on Mitsubishi, Nissan, Opel, Vauxhall and VW vehicles. Made from heat treated cast steel.



Set contains:

22mm (7/8") hex, 1/2" square drive socket with 7.5mm side slot for sensor wire clearance. Socket has 22mm hex for use with a spanner. **Overall length:** 80mm. 22mm (7/8") hex, crow's foot style wrench, 1/2" square drive (double square for easy access). With full length 11mm slot for total clearance of switch/sensor wire. 22mm (7/8") hex, crow's foot style wrench, 3/8" square drive. With full length 8.6mm slot for total clearance of switch/sensor wire.

Description	Order Code
Sensor Socket Set	KEN-503 -8020K

Oil Filter Cap Wrench Set

Cap type filter wrenches made from chrome vanadium with a satin finish. Use with 3/8" or 1/2" square drive wrenches to remove paper cartridge style oil filters.

Contents: 24, 27, 30, 32, 36, 38mm and 1/2" - 3/8" adaptor.

**7
PIECES**



Diameter (mm)	Weight each	Order Code
60 - 140	430g	KEN-503 -1790K

GROUP 582 SOCKETS SETS - 1/2" SQUARE DRIVE



1/2" Square Drive The most popular drive size used in the service and maintenance industries. This popularity is due to the strength and robust nature of 1/2" drive. All Kennedy Professional sockets have a knurl feature to give a high grip which is essential for a quick tool change when your hands are greasy/oily. The 12 point bi-hexagon side drive design will give a higher torque than normal sockets, grip worn nuts and will not round off existing nuts. Manufactured from chrome vanadium and are fully chrome plated with an aluminium free mirror finish. Chamfered leading edge ensures easy fastener location. Sockets manufactured to: **ANSI B107.5M : 1987, ANSI B107.1 : 1978 & BS 4006 : 1992.** Accessories manufactured to: **ANSI B107.10M : 1982 & BS 4006 : 1992.**



M20M - 20 Piece Metric



Sockets: 10, 11, 12, 13, 14, 15, 17, 19, 22, 24, 27, 30 and 32mm.

Spark Plug Sockets: M10 and M14.

Accessories: quick release ratchet handle, sliding T-handle, universal joint, 125 and 250mm extension bars. Robust fitted case with security padlock hole and cushion grip handle.



**20
PIECES**

Accessories

Number of Pieces	Weight each	Order Code
20	4.90kg	-7983K

Description	Order Code
	KEN-567
Locking Clasps (Pair)	-6000K

M25M - 25 Piece Metric



Sockets: 8, 9, 10, 11, 12, 13, 14, 15, 16, 17, 18, 19, 22, 24, 27, 30 and 32mm.

Spark Plug Sockets: M10 and M14.

Accessories: quick release ratchet handle, sliding T-handle, universal joint, 75, 125 and 250mm extension bars. Robust fitted case with security padlock hole and cushion grip handle.

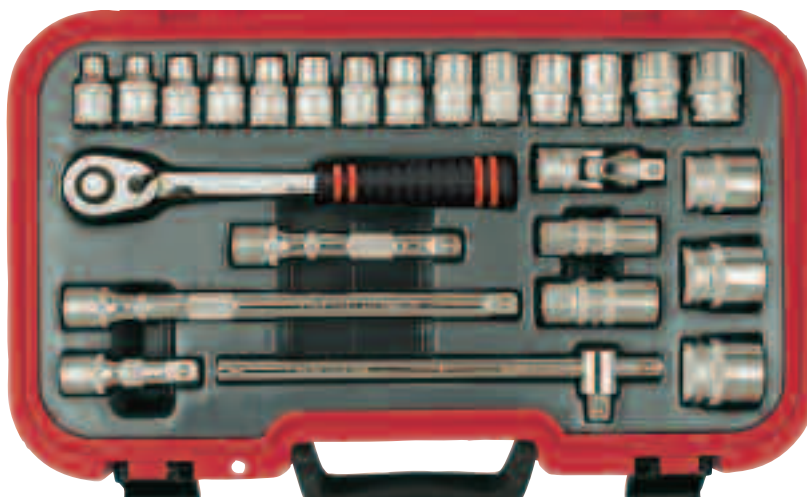

**25
PIECES**

Accessories

Number of Pieces	Weight each	Order Code
25	4.90kg	-7985K

Description	Order Code
	KEN-567
Locking Clasps (Pair)	-6000K

M30MSH - 30 Piece Metric - Single Hexagon



Sockets: 8, 9, 10, 11, 12, 13, 14, 15, 16, 17, 18, 19, 20, 21, 22, 23, 24, 25, 26, 27, 30 and 32mm.

Spark Plug Sockets: M10 and M14.

Accessories: quick release ratchet handle, universal joint, sliding T-handle, 75, 125 and 250mm extension bars. Supplied in a fitted impact-resistant plastic carry case with a cushioned handle, snap-shut clasps and padlock hasp hole.



**30
PIECES**

Number of Pieces	Weight each	Order Code
30	5.55kg	-7940K

HAND TOOLS



1/2" Square Drive The most popular drive size used in the service and maintenance industries. This popularity is due to the strength and robust nature of 1/2" drive. All Kennedy Professional sockets have a knurl feature to give a high grip which is essential for a quick tool change when your hands are greasy/oily.

The 12 point bi-hexagon side drive design will give a higher torque than normal sockets, grip worn nuts and will not round off existing nuts. Manufactured from chrome vanadium and are fully chrome plated with an aluminium free mirror finish. Chamfered leading edge ensures easy fastener location. Sockets manufactured to: **ANSI B107.5M : 1987, ANSI B107.1 : 1978 & BS 4006 : 1992.** Accessories manufactured to: **ANSI B107.10M : 1982 & BS 4006 : 1992.**

M30M - 30 Piece Metric

Sockets: 8, 9, 10, 11, 12, 13, 14, 15, 16, 17, 18, 19, 20, 21, 22, 23, 24, 25, 26, 27, 30 and 32mm.

Spark Plug Sockets: M10 and M14.

Accessories: quick release ratchet handle, sliding T-handle, universal joint, 75, 125 and 250mm extension bars. Robust fitted case with security padlock hole and cushion grip handle.



**30
PIECES**

Number of Pieces	Weight each	Order Code
30	5.50kg	-7991K

Accessories	Order Code
Locking Clasps (Pr)	-6000K

M30MA - 30 Piece Metric & Inch

Sockets: 8, 9, 10, 11, 12, 13, 14, 15, 16, 17, 18, 19, 22, 24 and 24mm. 3/8", 7/16", 1/2", 9/16", 5/8", 11/16", 3/4" and 7/8" AF.

Spark Plug Sockets: M10 and M14.

Accessories: quick release ratchet handle, sliding T-handle, universal joint, 75, 125 and 250mm extension bars. Robust fitted case with security padlock hole and cushion grip handle.



**30
PIECES**

Number of Pieces	Weight each	Order Code
30	5.30kg	-7987K

Accessories	Order Code
Locking Clasps (Pr)	-6000K

MD30MA - 30 Piece Deep Metric & Inch

Sockets: 10, 11, 12, 13, 14, 15, 16, 17, 18, 19, 21, 22, 24, 26, 27, 30 and 32mm. 1/2", 9/16", 5/8", 11/16", 3/4", 13/16", 7/8", 15/16", 1", 1 1/8" and 1 1/4" AF.

Accessories: offset handle, swivel handle. Parts tray with magnetic insert. Robust fitted case with security padlock hole and cushion grip handle.



**30
PIECES**

Number of Pieces	Weight each	Order Code
30	12.2kg	-7997K

Accessories	Order Code
Locking Clasps (Pr)	-6000K

PRODUCTS ARE ONLY AVAILABLE VIA YOUR DISTRIBUTOR

HAND TOOLS

GROUP 582 SOCKETS SETS - 1/2" SQUARE DRIVE

KENNEDY PROFESSIONAL MS50M - 50 Piece Metric with Driver Bits

Sockets: 8, 9, 10, 11, 12, 13, 14, 15, 16, 17, 18, 19, 20, 21, 22, 23, 24, 25, 26, 27, 28, 29, 30, 32, 33 and 36mm.

Screwdriver Bits: Crosspoint No.2, No.3, No.4. Hex 4, 5, 6, 7, 8, 10, 12, 14, 17 and 19mm. **Screwdriver Bits:** 9 and 14mm

Spark Plug Sockets: M10 and M14.

Accessories: Quick release ratchet handle, sliding T-handle, swivel handle, universal joint 75, 125 and 250mm extension bars.

Parts tray with magnetic insert. Robust fitted case with security padlock hole and cushion grip handle.

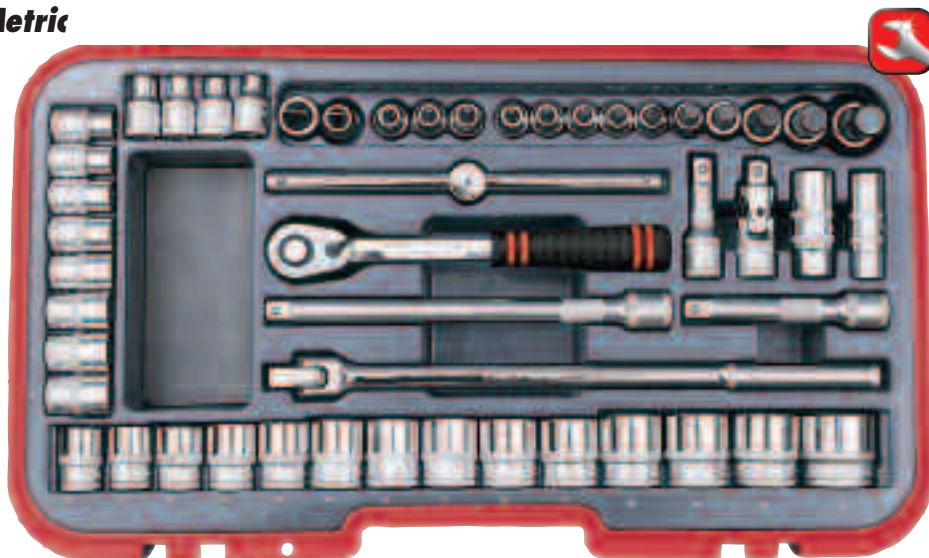

**50
PIECES**

Number of Pieces	Weight each	Order Code
50	9.85kg	-7993K

Accessories	Order Code
Locking Clasps (Pr)	-6000K

M70MAW - 70 Piece Metric, Inch & Whitworth

Sockets: 8, 9, 10, 11, 12, 13, 14, 15, 16, 17, 18, 19, 20, 21, 22, 23, 24, 25, 26, 27, 28, 29, 30, 32, 33 and 36mm. 5/16", 3/8", 7/16", 1/2", 9/16", 19/32", 5/8", 11/16", 3/4", 13/16", 7/8", 15/16", 1", 1 1/16", 1 1/8", 1 3/16" and 1 1/4" AF. 1/8", 3/16", 1/4", 5/16", 3/8", 7/16", 1/2", 9/16", 5/8", 11/16" and 3/4" Whit.

Hex Bit Adaptors: 1/4" and 5/16".

Spark Plug Sockets: M10 and M14.

Convertors: 1/2" sq. female x 3/4" sq. male, 1/2" sq. female x 3/8" sq. male.

Accessories: quick release ratchet handle, sliding T-handle, swivel handle, universal joint, 75, 125, 250, and 450mm extension bars, 125 and 250mm wobble extensions. Robust fitted case with security padlock hole and cushion grip handle.

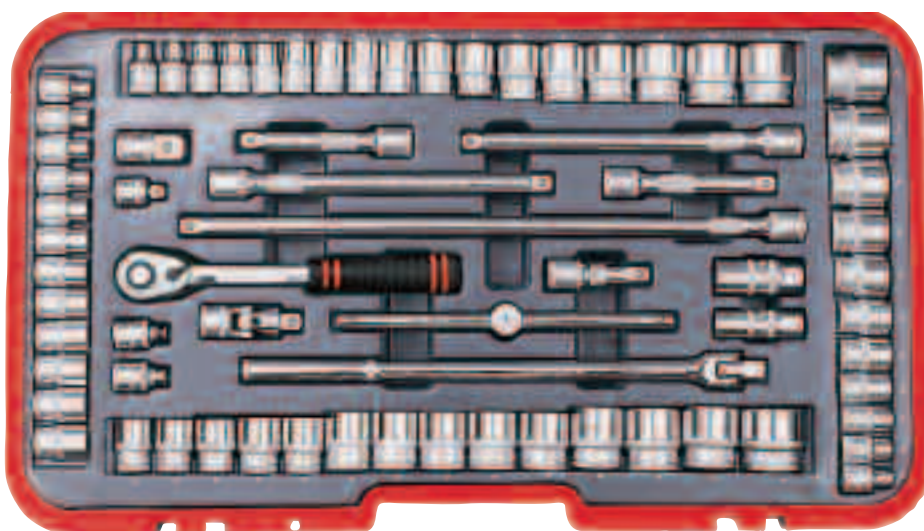

**70
PIECES**

Number of Pieces	Weight each	Order Code
70	12.2kg	-7995K

Accessories	Order Code
Locking Clasps (Pr)	-6000K

YAMOTO INDUSTRIAL SOCKET SETS

1/2" Square Drive Manufactured from industrial quality chrome vanadium steel with corrosion resistant high polish mirror finish, aluminium-free to ensure non-sparking. The 12 point bi-hexagonal side drive sockets allow higher torques to be applied to nuts without damage and to grip worn nuts. The strength and robust design of 1/2" drive make them suitable for the heavy use encountered in agriculture, service and maintenance industries. Sockets manufactured to: **ANSI B107.5M:1987**. Accessories manufactured to: **ANSI B107.10M:1982**.

50 Piece Metric, Inch & Whitworth

Sockets: 8, 9, 10, 11, 12, 13, 14, 15, 16, 17, 18, 19, 20, 21, 22, 24, 27, 30 and 32mm. 5/16", 3/8", 7/16", 1/2", 9/16", 5/8", 11/16", 3/4", 13/16", 7/8", 15/16", 1", 1 1/16", 1 1/8", 1 1/4" A/F. 3/16", 1/4", 5/16", 3/8", 7/16", 1/2", 9/16" and 5/8" Whit.

Spark Plug Sockets: M14 and M10.

Accessories: quick release flick lever ratchet with rubber grip, T-handle, swivel handle with rubber grip, universal joint, extension bars 125 and 250mm. Robust fitted case with magnetic parts tray, padlock hole and cushion grip handle.



**50
PIECES**

Number of Pieces	Weight each	Order Code
50	9.40kg	-7996K

Accessories	Order Code
Replacement Case	-2950K

HAND TOOLS

SENATOR
QUALITY TOOLING

SH 26MA - 26 Piece Metric & Inch

Sockets: 22, 24, 27, 30, 32, 36, 38, 41, 46 and 50mm. 7/8", 15/16", 1", 1 1/8", 1 3/16", 1 5/16", 1 3/8", 1 7/16", 1 5/8", 1 3/4", 1 7/8" and 2" AF.

Accessories: 100 and 200mm extension bars, ratchet handle and T-handle.

26
PIECES

HOME IMPROVER

Number of Pieces	Weight each	Order Code
26	18.0kg	SEN-582 -0200K



KENNEDY
PROFESSIONAL

3/4" Drive A heavy duty range designed to cope with the demands of industrial agriculture machinery and heavy plant, static or mobile. All Kennedy Professional sockets have a knurl feature to give a high grip which is essential for a quick tool change when your hands are greasy/oily. The 12 point bi-hexagon side drive design will give a higher torque than normal sockets, grip worn nuts and will not round off existing nuts. Manufactured from chrome vanadium and are fully chrome plated with an aluminium free mirror finish. Chamfered leading edge ensures easy fastener location. Sockets manufactured to: **ANSI B107.5M: 1987, ANSI B107.1: 1978 & BS 4006: 1992.**

Accessories manufactured to:

ANSI B107.10M: 1982 & BS 4006: 1992.

L22M - 22 Piece Metric

Bi-Hexagon Sockets: 22, 24, 26, 27, 29, 30, 32, 33, 36, 38, 41, 46, 50, 55 and 60mm.

Accessories: lever type ratchet, sliding T-handle, swivel handle, universal joint, 100, 200 and 410mm extension bars. Robust fitted case with security padlock hole and cushion grip handle.

22
PIECES

Number of Pieces	Weight each	Order Code
22	23.8kg	KEN-582 -8720K

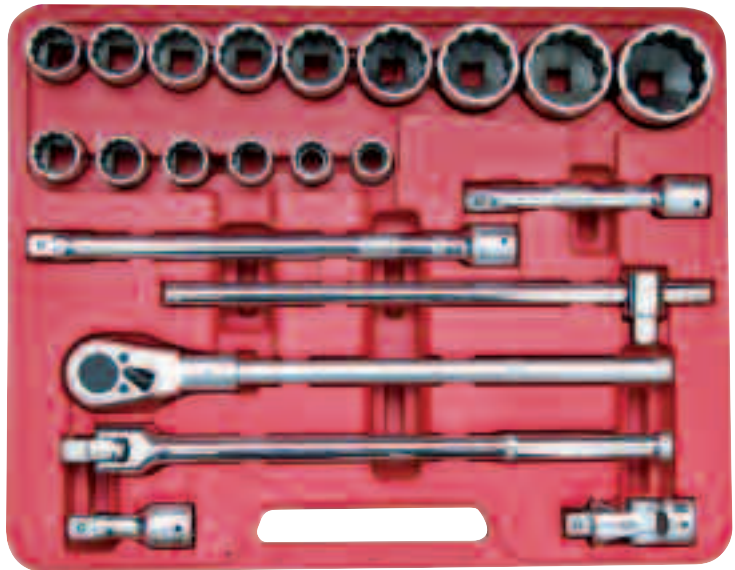

L36MA - 36 Piece Metric & Inch

Bi-Hexagon Sockets: 22, 24, 27, 29, 30, 32, 33, 36, 38, 41, 46, and 50mm. 7/8", 15/16", 1", 1 1/16", 1 1/8", 1 3/16", 1 1/4", 1 5/16", 1 3/8", 1 7/16", 1 1/2", 1 5/8", 1 11/16", 1 3/4", 1 13/16", 1 7/8" and 2" AF.

Accessories: ratcheting head with 550mm universal handle, sliding T-handle, 1" to 3/4" converter, 200 and 400mm extension bars.

36
PIECES

Number of Pieces	Weight each	Order Code
36	29.3kg	KEN-582 -8740K

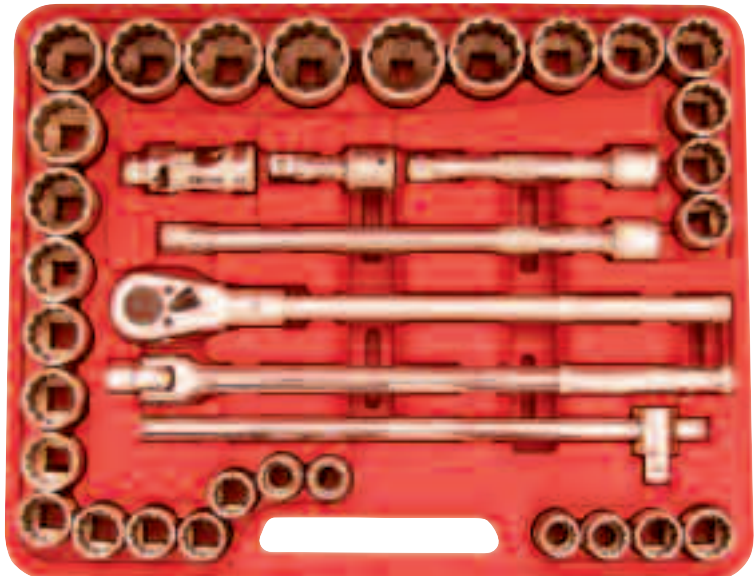

15 Piece Metric Socket Set

Sockets: 36, 41, 46, 50, 55, 60, 65, 70, 75 and 80mm.

Accessories: ratchet and sliding T-handle, 550mm universal handle, 200 and 400mm extension bars.

15
PIECES

Number of Pieces	Weight each	Order Code
15	18.0kg	KEN-582 -9470K



HAND TOOLS



Chrome Molybdenum Impact Sockets & Accessories

Manufactured from high quality chrome molybdenum steel. Black oxidised finish with permanent laser etched markings.

1/4" Drive Metric, Standard Length, 6-Point
Conform to: **DIN 3129.**

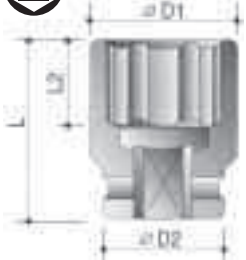

Style A Style B

Socket (mm)	Style	Dimensions (mm)				Weight each	Order Code KEN-583
		D2	D1	L2	L		
6	A	13.0	10.0	6.0	23.0	15g	-0640K
7	A	13.0	11.3	6.0	23.0	15g	-0650K
8	A	13.0	12.5	7.0	23.0	15g	-0660K
9	A	13.0	13.8	7.0	23.0	15g	-0670K
10	A	13.0	15.0	7.0	23.0	17g	-0680K
11	A	13.0	16.3	8.0	23.0	20g	-0690K
12	B	13.0	17.0	8.0	23.0	17g	-0700K
13	B	13.0	18.8	8.0	23.0	22g	-0710K
14	B	13.0	20.0	8.0	23.0	20g	-0720K

1/4" Drive Reducers & Adaptors



Male Drive x Female Drive	Weight each	Order Code KEN-583
3/8" x 1/4"	40g	-7380K
1/4" x 3/8"	40g	-7400K

3/8" Drive Metric, Standard Length, 6-Point
Conform to: **DIN 3129.**

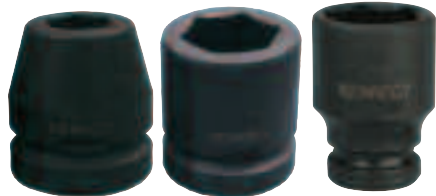

Style A Style B Style C

Socket (mm)	Style	Dimensions (mm)				Weight each	Order Code KEN-583
		D2	D1	L2	L		
6	A	19.0	11.0	4.0	30.0	35g	-1240K
7	A	19.0	12.5	8.0	30.0	40g	-1250K
8	A	19.0	13.8	8.0	30.0	40g	-1260K
9	A	19.0	15.0	8.0	30.0	40g	-1270K
10	A	19.0	16.0	8.0	30.0	40g	-1280K
11	A	19.0	17.5	9.0	30.0	40g	-1290K
12	B	19.0	19.0	9.0	30.0	40g	-1300K
13	A	22.0	20.0	9.0	30.0	55g	-1310K
14	A	22.0	21.0	9.0	30.0	55g	-1320K
15	B	22.0	22.0	11.0	30.0	55g	-1330K
16	C	22.0	24.0	11.0	30.0	60g	-1340K
17	C	22.0	25.0	11.0	30.0	60g	-1350K
18	C	22.0	26.0	11.0	30.0	60g	-1360K
19	C	22.0	27.5	11.0	30.0	70g	-1370K
20	C	22.0	28.0	12.0	30.0	70g	-1380K
21	C	22.0	30.0	13.0	30.0	70g	-1390K
22	C	24.0	32.0	13.0	30.0	85g	-1400K

3/8" Drive Reducers & Adaptors



Male Drive x Female Drive	Weight each	Order Code KEN-583
3/8" x 1/4"	40g	-7380K
1/4" x 3/8"	40g	-7400K
1/2" x 3/8"	70g	-7410K
3/8" x 1/2"	70g	-7420K

1/4" Drive Extension Bars



Length (mm)	Weight each	Order Code KEN-583
50 (2")	24g	-7490K
100 (4")	43g	-7495K

3/8" Drive Inch Size, Standard Length, 6-Point
Conform to: **SAE, USA Federal Standard GGG-W-660A.**

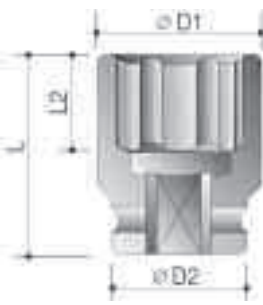

Style A Style B

Socket (inch)	Style	Dimensions (mm)				Weight each	Order Code KEN-583
		D2	D1	L2	L		
1/4"	A	19.0	11.0	4.0	30.0	30g	-1430K
5/16"	A	19.0	12.5	8.0	30.0	30g	-1440K
3/8"	A	19.0	14.5	8.0	30.0	35g	-1460K
7/16"	A	19.0	17.0	9.0	30.0	35g	-1470K
1/2"	B	19.0	19.0	9.0	30.0	35g	-1480K
9/16"	B	20.0	20.0	9.0	30.0	40g	-1490K
5/8"	B	24.0	24.0	11.0	30.0	70g	-1500K
11/16"	B	24.0	24.0	11.0	30.0	70g	-1510K
3/4"	B	26.0	26.0	11.0	30.0	80g	-1520K

3/8" Drive Extension Bars



Length (mm)	Weight each	Order Code KEN-583
50 (2")	24g	-7500K
100 (4")	43g	-7510K



HAND TOOLS

IMPACT SOCKETS - 3/8" SQUARE DRIVE

KENNEDY Impact Sockets

Manufactured from high quality chrome molybdenum steel. Black oxidised finish with permanent laser etched markings.

3/8" Drive Metric, Deep Length, 6-Point
Conform to: **DIN 3129.**



Style A



Style B



Style C

Socket (mm)	Style	Dimensions (mm)				Weight each	Order Code KEN-583
		D2	D1	L2	L		
7	A	19.0	12.5	12.0	65.0	75g	-1700K
8	A	19.0	13.8	12.0	65.0	80g	-1710K
10	A	19.0	16.0	12.0	65.0	80g	-1720K
11	A	19.0	17.5	25.0	65.0	80g	-1730K
12	B	19.0	19.0	25.0	65.0	90g	-1740K
13	A	22.0	20.0	25.0	65.0	120g	-1750K
14	A	22.0	21.0	25.0	65.0	120g	-1650K
15	B	22.0	22.0	25.0	65.0	120g	-1760K
16	C	22.0	24.0	25.0	65.0	140g	-1770K
17	C	22.0	25.0	25.0	65.0	140g	-1780K
18	C	22.0	26.0	25.0	65.0	150g	-1790K
19	C	22.0	27.5	25.0	65.0	170g	-1800K
21	C	22.0	30.0	25.0	65.0	185g	-1820K

3/8" Drive Inch Size, Deep Length, 6-Point
Conform to: **SAE, USA Federal Standard GGG-W-660A.**

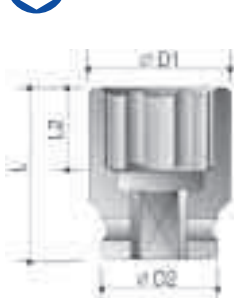

Style A



Style B

Socket (inch)	Style	Dimensions (mm)				Weight each	Order Code KEN-583
		D2	D1	L2	L		
3/8"	A	19.0	14.5	12.0	65.0	80g	-1840K
7/16"	A	19.0	17.0	25.0	65.0	80g	-1850K
1/2"	B	19.0	19.0	25.0	65.0	90g	-1860K
9/16"	B	20.0	20.0	25.0	65.0	100g	-1870K
3/4"	B	26.0	26.0	25.0	65.0	100g	-1880K

KENNEDY Square Drive Impact Extractor Sockets

Extracts rounded, seized or painted right hand threaded fasteners, the reverse spiral flutes are designed to bite into seized nuts and bolts providing greater grip for extraction. The ejector pin is to drive out the fasteners from sockets, once removed.

Contents: 10, 11, 12, 13, 14, 15, 16, 17 and 19mm extractor sockets plus ejector pin.

10 PIECES

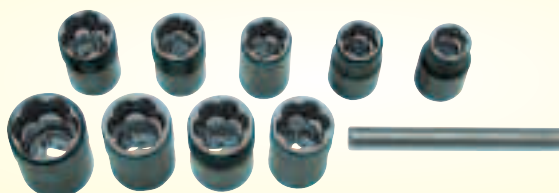

Replacement Ejector Pin

Product Number	Sizes (mm)	Weight each	Order Code KEN-583
SSE10M	10 - 19	660g	-9800K

To Suit	Weight each	Order Code KEN-583
SSE10M	11g	-7960K

Individual Extractor Sockets



Size (mm)	Weight each	Order Code KEN-583
10	33g	-1980K
11	34g	-1981K
12	35g	-1982K
13	36g	-1983K
14	37g	-1984K
15	51g	-1985K
16	57g	-1986K
17	68g	-1987K
19	85g	-1989K



Hex Driver Impact Sockets 3/8" Sq. Dr.

3/8 Hexagon sizes: 4, 5, 6, 7, 8, 10 and 12mm.
Conforms to **DIN 3129.**



Size (mm)	Overall Length	Weight each	Order Code KEN-583
4	50mm	40g	-1960K
5	50mm	45g	-1962K
6	50mm	45g	-1964K
7	50mm	45g	-1966K
8	50mm	50g	-1968K
10	50mm	60g	-1970K
12	50mm	70g	-1972K

7 Piece Set
Contents as above.

7 PIECES



Number of Pieces	Weight each	Order Code KEN-583
7	550g	-9820K

Impact Socket Set

3/8 Standard length: metric 6, 7, 8, 9, 10, 11, 12, 13, 14, 15, 16, 17, 18, 19, 20, 21 and 22mm.

Standard length: A/F 1/4", 5/16", 3/8", 7/16", 1/2", 9/16", 5/8", 11/16" and 3/4".

Deep metric: 7, 8, 10, 11, 12, 13, 14, 15, 16, 17, 18, 19 and 21mm.

39 PIECES



Number of Pieces	Weight each	Order Code KEN-583
39	3.50kg	-9810K

HAND TOOLS

GROUP 583 IMPACT SOCKETS - 1/2" SQUARE DRIVE

KENNEDY *Chrome Molybdenum Impact Sockets*



Manufactured from high quality chrome molybdenum steel. Black oxidised finish with permanent laser etched markings.

1/2" Drive Metric, Standard Length, 6-Point
Conform to: **DIN 3129.**

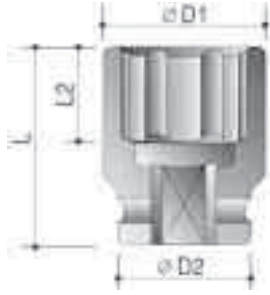

Socket (mm)	Style	Dimensions (mm)				Weight each	Order Code KEN-583
		D2	D1	L2	L		
9	A	25.0	12.0	12.0	38.0	90g	-2010K
10	A	25.0	17.5	12.0	38.0	90g	-2020K
11	A	25.0	18.7	12.0	38.0	95g	-2030K
12	A	25.0	20.0	12.0	38.0	100g	-2040K
13	A	25.0	21.0	12.0	38.0	100g	-2050K
14	A	25.0	22.5	12.0	38.0	100g	-2060K
15	A	30.0	23.7	12.0	38.0	140g	-2070K
16	A	30.0	25.0	12.0	38.0	140g	-2080K
17	A	30.0	26.0	13.0	38.0	140g	-2090K
18	A	30.0	27.5	13.0	38.0	140g	-2100K
19	A	30.0	28.7	13.0	38.0	140g	-2110K
20	B	30.0	30.0	13.0	38.0	140g	-2120K
21	B	30.0	30.0	13.0	38.0	130g	-2130K
22	C	30.0	32.0	13.0	38.0	140g	-2140K
23	C	30.0	32.0	13.0	38.0	140g	-2150K
24	C	30.0	35.0	20.0	45.0	180g	-2160K
26	C	30.0	38.0	22.0	50.0	200g	-2180K
27	C	30.0	38.7	22.0	50.0	310g	-2190K
28	C	30.0	40.0	22.0	50.0	230g	-2200K
30	C	30.0	42.0	22.0	50.0	230g	-2220K
32	C	30.0	44.0	28.0	50.0	250g	-2230K
36	C	30.0	49.0	28.0	50.0	250g	-2250K



1/2" Drive Inch Size, Standard Length, 6-Point
Conform to: **SAE, USA Federal Standard GGG-W-660A.**

Socket (inch)	Style	Dimensions (mm)				Weight each	Order Code KEN-583
		D2	D1	L2	L		
3/8"	A	22.0	16.0	12.0	38.0	70g	-2270K
7/16"	A	22.0	18.0	12.0	38.0	70g	-2280K
1/2"	A	22.0	20.0	12.0	38.0	70g	-2290K
9/16"	A	24.0	22.0	12.0	38.0	80g	-2300K
5/8"	B	25.0	25.0	12.0	38.0	85g	-2320K
11/16"	B	26.0	26.0	13.0	38.0	90g	-2330K
3/4"	B	28.0	28.0	13.0	38.0	100g	-2340K
13/16"	B	30.0	30.0	13.0	38.0	125g	-2350K
7/8"	B	32.0	32.0	13.0	38.0	150g	-2360K
15/16"	B	34.0	34.0	13.0	38.0	170g	-2370K
1"	B	36.0	36.0	14.0	38.0	190g	-2380K
1 1/16"	B	38.0	38.0	16.0	40.0	205g	-2390K
1 1/8"	C	38.0	40.0	16.0	40.0	235g	-2400K
1 3/16"	C	38.0	42.0	16.0	40.0	255g	-2410K
1 1/4"	C	38.0	44.0	18.0	40.0	270g	-2420K

1/2" Drive BSW Size, Standard Length, 6-Point
Conform to: **SAE, USA Federal Standard GGG-W-660A.**

Socket (BSW)	Style	Dimensions (mm)				Weight each	Order Code KEN-583
		D2	D1	L2	L		
5/16"	A	30.0	25.0	12.0	38	140g	-2510K
3/8"	A	30.0	27.5	13.0	38	140g	-2520K
7/16"	B	30.0	30.0	13.0	38	140g	-2530K
1/2"	C	30.0	35.0	20.0	45	190g	-2540K
9/16"	C	30.0	38.0	22.0	50	210g	-2550K
5/8"	C	30.0	40.0	22.0	50	305g	-2560K
11/16"	C	30.0	44.0	28.0	50	305g	-2570K
3/4"	C	30.0	44.0	28.0	50	305g	-2580K

HAND TOOLS

Impact Socket Sets

The sockets are manufactured from the highest quality chrome molybdenum steel which is clearly laser etched with the size for easy and rapid identification. Tough, impact-resistant carry case. Conforms to: **Metric DIN 3129, Inch SAE USA Federal Standard GGG-W-660A.**

9 Piece Set - Metric

1/2" Standard length: 10, 12, 13, 14, 17, 19, 24, 27 and 30mm.

**9
PIECES**



Number of Pieces	Weight each	Order Code KEN-583
9	1.70kg	-9870K

18 Piece Set - Metric

1/2" Standard length: 10, 11, 12, 13, 14, 15, 16, 17, 18, 19, 20, 21, 22, 24, 26, 27, 30 and 32mm.

**18
PIECES**



Number of Pieces	Weight each	Order Code KEN-583
18	3.40kg	-9860K

KENNEDY Chrome Molybdenum Impact Sockets



Manufactured from high quality chrome molybdenum steel. Black oxidised finish with permanent laser etched markings.

1/2" Drive Reducers & Adaptors

Male Drive x Female Drive	Weight each	Order Code KEN-583
1/2" x 3/8"	70g	-7410K
3/8" x 1/2"	70g	-7420K
3/4" x 1/2"	175g	-7430K
1/2" x 3/4"	335g	-7440K



Universal Ball Joint

Male Drive x Female Drive	Weight each	Order Code KEN-583
1/2" x 1/2"	140g	-7840K



1/2" Drive Metric, Deep Length, 6-Point
Conform to: **DIN 3129**.

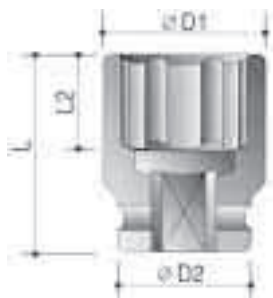

Socket (mm)	Style	Dimensions (mm)				Weight each	Order Code KEN-583
		D2	D1	L2	L		
10	A	25.0	17.5	14.0	78.0	170g	-2600K
11	A	25.0	18.7	14.0	78.0	170g	-2610K
12	A	25.0	20.0	14.0	78.0	175g	-2620K
13	A	25.0	21.0	14.0	78.0	180g	-2630K
14	A	25.0	22.5	17.0	78.0	210g	-2640K
15	A	30.0	23.7	17.0	78.0	200g	-2650K
16	A	30.0	25.0	17.0	78.0	200g	-2660K
17	A	30.0	26.0	17.0	78.0	260g	-2670K
18	A	30.0	27.5	17.0	78.0	270g	-2680K
19	A	30.0	28.7	19.0	78.0	260g	-2690K
21	B	30.0	30.0	24.0	78.0	260g	-2700K
22	C	30.0	32.0	24.0	78.0	290g	-2710K
23	C	30.0	32.0	24.0	78.0	290g	-2720K
24	C	30.0	35.0	24.0	78.0	290g	-2730K
27	C	30.0	38.7	54.0	78.0	330g	-2740K
28	C	30.0	40.0	54.0	78.0	350g	-2750K
30	C	30.0	42.0	54.0	78.0	450g	-2760K
32	C	30.0	44.0	54.0	78.0	370g	-2770K

1/2" Drive Extension Bars

Length (mm)	Weight each	Order Code KEN-583
125 (5")	230g	-7520K
150 (6")	270g	-7530K
250 (10")	445g	-7540K
300 (12")	620g	-7550K
380 (15")	740g	-7560K



Hub Nut Impact Socket Set - 7 Piece

These extra deep sockets are six point single hexagon with a black oxidised finish and conform to **DIN 3129, Inch SAE and USA Federal Standard GGG-W-660A**. Impact resistant storage case.

Socket sizes:
29, 30, 32, 34, 35, 36 and 38mm.



Number of Pieces	Weight each	Order Code KEN-583
7	5.3kg	-9888K

1/2" Drive Inch Size, Deep Length, 6-Point
Conform to: **SAE, USA Federal Standard GGG-W-660A**.

Socket (inch)	Style	Dimensions (mm)				Weight each	Order Code KEN-583
		D2	D1	L2	L		
3/8"	A	22.0	16.0	14.0	78.0	140g	-2780K
7/16"	A	22.0	18.0	14.0	78.0	160g	-2790K
1/2"	A	22.0	20.0	14.0	78.0	200g	-2800K
9/16"	A	24.0	22.0	17.0	78.0	180g	-2810K
5/8"	B	24.0	24.0	17.0	78.0	210g	-2820K
11/16"	B	26.0	26.0	17.0	78.0	190g	-2830K
3/4"	B	28.0	28.0	19.0	78.0	235g	-2840K
13/16"	B	30.0	30.0	24.0	78.0	260g	-2850K
7/8"	B	32.0	32.0	24.0	78.0	290g	-2860K
15/16"	B	34.0	34.0	24.0	78.0	340g	-2870K
1"	B	36.0	36.0	24.0	78.0	340g	-2880K
1 1/16"	B	38.0	38.0	24.0	78.0	440g	-2890K
1 1/8"	C	38.0	40.0	24.0	78.0	410g	-2900K

1/2" Drive BSW Size, Deep Length, 6-Point
Conform to: **SAE, USA Federal Standard GGG-W-660A**.

Socket (BSW)	Style	Dimensions (mm)				Weight each	Order Code KEN-583
		D2	D1	L2	L		
5/16"	A	30.0	25.0	17.0	78	200g	-2910K
3/8"	A	30.0	27.5	17.0	78	250g	-2920K
7/16"	B	30.0	30.0	24.0	78	300g	-2930K
1/2"	C	30.0	35.0	24.0	78	360g	-2940K
9/16"	C	30.0	38.7	24.0	78	440g	-2950K
5/8"	C	30.0	40.0	24.0	78	480g	-2960K
11/16"	C	30.0	44.0	24.0	78	500g	-2970K
3/4"	C	30.0	44.0	24.0	78	450g	-2980K

7 Piece Set - Deep Metric

10, 13, 14, 17, 19, 24 and 30mm.



Number of Pieces	Weight each	Order Code KEN-583
7	2.20kg	-9880K

HAND TOOLS

GROUP 583 IMPACT SOCKETS - 1/2" SQUARE DRIVE



Impact Wheel Nut Sockets

Socket sizes: 17, 19 and 21mm.
Colour coded for easy identification.
Can be used with retainer rings or pins.



Size (mm)	Overall Length	Weight each	Order Code KEN-583
17	85mm	225g	-3080K
19	85mm	225g	-3082K
21	85mm	255g	-3084K

3 Piece Set



Contains one of each size 17, 19 and 21mm.



**3
PIECES**



Number of Pieces	Weight each	Order Code KEN-583
3	895g	-9886K

Impact Hexagon Bit Drivers

Hexagon sizes: 6, 7, 8, 10, 12, 14, 15, 17, 18 and 19mm.



Size (mm)	Overall Length	Weight each	Order Code KEN-583
6	75mm	95g	-3010K
7	75mm	95g	-3012K
8	75mm	105g	-3014K
10	75mm	120g	-3016K
12	75mm	130g	-3018K
14	75mm	150g	-3020K
15	75mm	155g	-3022K
17	75mm	175g	-3024K
18	75mm	195g	-3026K
19	75mm	200g	-3028K

10 Piece Set



Contains one of each size 6mm to 19mm as shown left.

**10
PIECES**



Number of Pieces	Weight each	Order Code KEN-583
10	1.76kg	-9882K

Impact TX Bit Driver Sockets

TX drivers: T40, T45, T47, T50, T55, T60 and T70.



Size	Overall Length	Weight each	Order Code KEN-583
T40	55mm	80g	-3060K
T45	55mm	80g	-3062K
T47	55mm	85g	-3064K
T50	55mm	85g	-3066K
T55	55mm	90g	-3068K
T60	55mm	95g	-3070K
T70	55mm	105g	-3072K

16 Piece Set Contents:



TX drivers (length 55mm): T40, T45, T47, T50, T55, T60, T70.

**16
PIECES**

TX sockets: E10, E11, E12, E14, E16, E18, E20, E22, E24.
Conform to **DIN 3129**. Supplied in tough, impact-resistant plastic storage case.

Impact TX Sockets



Size	Overall Length	Weight each	Order Code KEN-583
E10	40mm	70g	-3040K
E11	40mm	70g	-3042K
E12	40mm	70g	-3044K
E14	45mm	75g	-3046K
E16	45mm	75g	-3048K
E18	45mm	75g	-3050K
E20	45mm	115g	-3052K
E22	45mm	140g	-3054K
E24	45mm	145g	-3056K

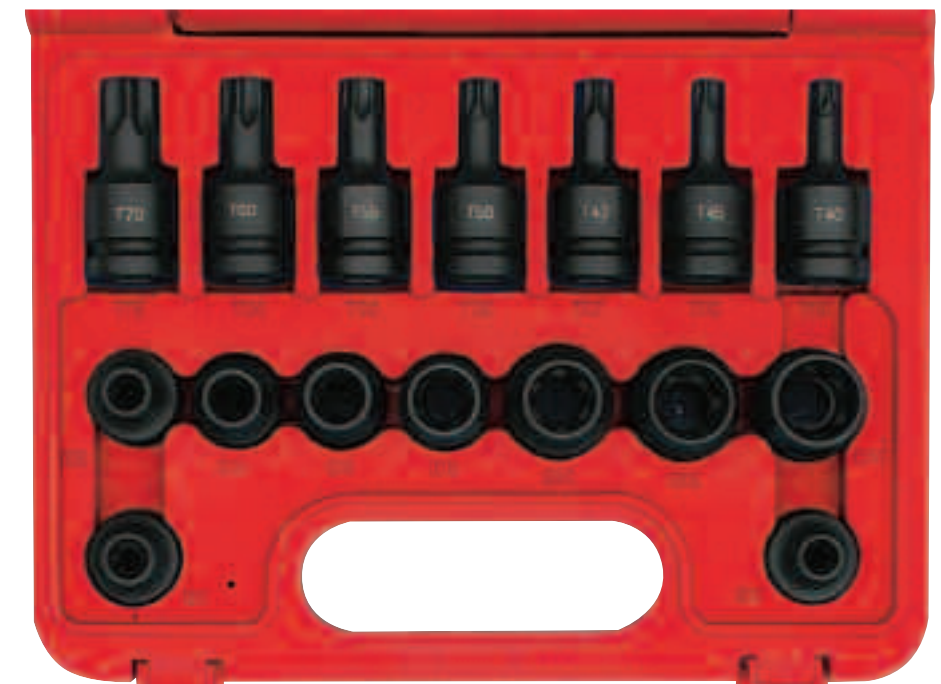

Number of Pieces	Weight each	Order Code KEN-583
16	1.91kg	-9884K

HAND TOOLS

KENNEDY Chrome Molybdenum Impact Sockets



Manufactured from high quality chrome molybdenum steel. Black oxidised finish with permanent laser etched markings.

3/4" Drive Metric, Standard Length, 6-Point
Conform to: **DIN 3129.**

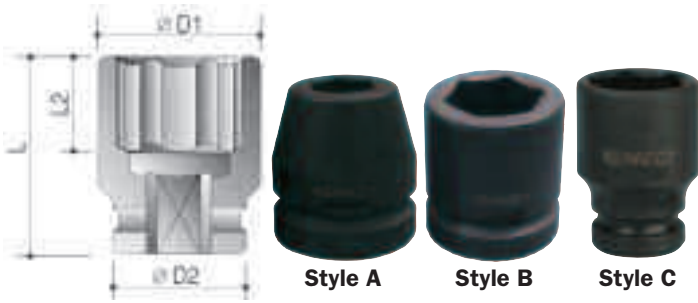

Socket (mm)	Style	Dimensions (mm)				Weight each	Order Code KEN-583
		D2	D1	L2	L		
16	A	44.0	27.0	11.0	50.0	367g	-3090K
17	A	44.0	31.0	12.0	50.0	400g	-3100K
18	A	44.0	32.0	13.0	50.0	433g	-3110K
19	A	44.0	33.0	13.0	50.0	433g	-3120K
20	A	44.0	34.0	14.0	50.0	433g	-3130K
21	A	44.0	35.0	15.0	50.0	400g	-3140K
22	A	44.0	37.0	15.0	50.0	400g	-3150K
23	A	44.0	38.0	16.0	50.0	400g	-3160K
24	A	44.0	39.0	16.0	50.0	433g	-3170K
25	A	44.0	40.0	16.0	50.0	433g	-3180K
26	A	44.0	41.0	16.0	50.0	433g	-3190K
27	A	44.0	43.0	19.0	54.0	433g	-3200K
28	B	44.0	44.0	19.0	54.0	433g	-3210K
29	C	44.0	45.0	21.0	54.0	450g	-3220K
30	C	44.0	47.0	21.0	54.0	500g	-3230K
32	C	44.0	49.0	22.0	56.0	500g	-3240K
33	C	44.0	51.0	22.0	56.0	500g	-3250K
34	C	44.0	52.0	22.0	56.0	550g	-3260K
35	C	44.0	53.0	22.0	56.0	550g	-3270K
36	C	44.0	54.0	25.0	56.0	600g	-3280K
38	C	44.0	57.0	25.0	58.0	600g	-3300K
41	C	44.0	60.0	27.0	58.0	700g	-3310K
42	C	44.0	62.0	27.0	58.0	700g	-3320K
46	C	44.0	67.0	30.0	63.0	800g	-3330K
47	C	44.0	68.0	30.0	68.0	900g	-3340K
50	C	54.0	71.0	32.0	72.0	1200g	-3350K

3/4" Drive Metric, Deep Length, 6-Point
Conform to: **DIN 3129.**

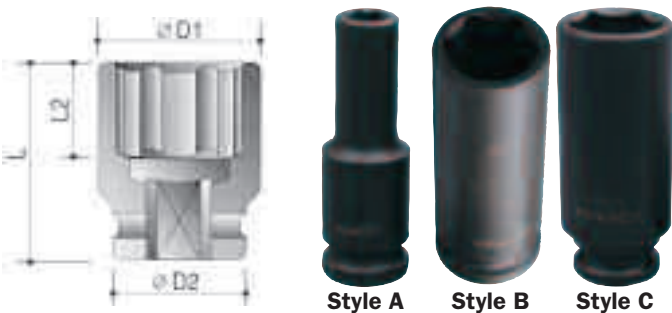

Socket (mm)	Style	Dimensions (mm)				Weight each	Order Code KEN-583
		D2	D1	L2	L		
17	A	44.0	31.0	17.0	95.0	600g	-3810K
18	A	44.0	32.0	18.0	95.0	600g	-3820K
19	A	44.0	33.0	19.0	95.0	600g	-3830K
21	A	44.0	35.0	21.0	95.0	650g	-3850K
22	A	44.0	37.0	22.0	95.0	700g	-3860K
24	A	44.0	39.0	24.0	95.0	700g	-3880K
25	A	44.0	40.0	25.0	95.0	700g	-3890K
26	A	44.0	41.0	26.0	95.0	700g	-3900K
27	A	44.0	43.0	27.0	95.0	700g	-3910K
28	B	44.0	44.0	28.0	95.0	750g	-3920K
30	C	44.0	47.0	30.0	95.0	800g	-3940K
32	C	44.0	49.0	32.0	95.0	900g	-3960K
33	C	44.0	51.0	33.0	95.0	1000g	-3970K
34	C	44.0	52.0	34.0	95.0	1000g	-3980K
36	C	44.0	54.0	36.0	95.0	1000g	-4000K
38	C	44.0	57.0	38.0	95.0	1100g	-4020K
41	C	44.0	60.0	38.0	95.0	900g	-4050K
42	C	44.0	62.0	38.0	95.0	1100g	-4060K
46	C	44.0	67.0	38.0	95.0	1300g	-4100K
47	C	44.0	68.0	38.0	95.0	1300g	-4110K

3/4" Drive Inch Size, Standard Length, 6-Point
Conform to: **SAE, USA Federal Standard GGG-W-660A.**

Socket (inch)	Style	Dimensions (mm)				Weight each	Order Code KEN-583
		D2	D1	L2	L		
5/8"	A	38.0	27.5	11.0	50	267g	-3360K
11/16"	A	38.0	29.0	12.0	50	267g	-3370K
3/4"	A	38.0	30.0	13.0	50	267g	-3380K
13/16"	A	38.0	32.0	15.0	52	300g	-3390K
7/8"	A	38.0	34.0	15.0	52	300g	-3400K
15/16"	A	38.0	36.0	16.0	52	300g	-3410K
1"	C	38.0	40.0	16.0	52	333g	-3420K
1 1/16"	C	38.0	40.0	19.0	52	333g	-3430K
1 1/8"	B	42.0	42.0	21.0	52	333g	-3440K
1 3/16"	B	44.0	44.0	21.0	52	367g	-3450K
1 1/4"	B	44.0	44.0	22.0	52	367g	-3460K
1 5/16"	C	44.0	47.0	22.0	56	450g	-3470K
1 3/8"	C	44.0	50.0	22.0	56	450g	-3480K
1 7/16"	C	44.0	51.0	25.0	56	500g	-3490K
1 1/2"	C	44.0	53.0	25.0	56	500g	-3500K
1 5/8"	C	44.0	58.0	27.0	62	700g	-3520K
1 11/16"	C	44.0	63.5	27.0	62	800g	-3530K
1 3/4"	C	44.0	65.0	27.0	62	800g	-3540K
1 13/16"	C	44.0	67.0	30.0	68	900g	-3550K
1 7/8"	C	44.0	68.0	30.0	68	900g	-3560K

3/4" Drive BSW Size, Standard Length, 6-Point
Conform to: **SAE, USA Federal Standard GGG-W-660A.**

Socket (BSW)	Style	Dimensions (mm)				Weight each	Order Code KEN-583
		D2	D1	L2	L		
9/16"	A	44.0	41.0	16.0	50	433g	-3620K
11/16"	C	44.0	48.0	21.0	56	450g	-3640K
3/4"	C	44.0	51.0	22.0	56	500g	-3650K
7/8"	C	44.0	57.0	25.0	58	600g	-3670K
1"	C	44.0	63.0	27.0	63	800g	-3690K
1 1/8"	C	44.0	68.0	30.0	68	900g	-3710K
1 1/4"	C	44.0	74.0	32.0	72	1100g	-3720K

3/4" Drive Inch Size, Deep Length, 6-Point
Conform to: **SAE, USA Federal Standard GGG-W-660A.**

Socket (inch)	Style	Dimensions (mm)				Weight each	Order Code KEN-583
		D2	D1	L2	L		
3/4"	A	38.0	30.0	19.0	85.0	433g	-4160K
7/8"	A	38.0	34.0	22.0	85.0	467g	-4180K
15/16"	A	38.0	36.0	24.0	85.0	467g	-4190K
1"	C	38.0	40.0	25.0	85.0	550g	-4200K
1 1/16"	C	38.0	40.0	27.0	85.0	550g	-4210K
1 1/8"	B	42.0	42.0	29.0	85.0	550g	-4220K
1 3/16"	B	44.0	44.0	30.0	85.0	600g	-4230K
1 1/4"	C	44.0	49.0	32.0	85.0	800g	-4240K
1 5/16"	C	44.0	50.0	34.0	85.0	800g	-4250K
1 7/16"	C	44.0	51.0	37.0	85.0	800g	-4270K
1 1/2"	C	44.0	57.0	38.0	95.0	1100g	-4280K
1 7/8"	C	44.0	68.0	38.0	95.0	1100g	-4340K

3/4" Drive BSW Size, Deep Length, 6-Point
Conform to: **SAE, USA Federal Standard GGG-W-660A.**

Socket (BSW)	Style	Dimensions (mm)				Weight each	Order Code KEN-583
		D2	D1	L2	L		
3/4"	C	44.0	51.0	33.0	95	1000g	-4450K
13/16"	C	44.0	53.0	35.0	95	1000g	-4460K
7/8"	C	44.0	57.0	38.0	95	1100g	-4470K

HAND TOOLS



Chrome Molybdenum Impact Sockets



Manufactured from high quality chrome molybdenum steel. Black oxidised finish with permanent laser etched markings.



3/4" Drive Reducers & Adaptors

Male Drive x Female Drive	Weight each	Order Code KEN-583
3/4" x 1/2"	175g	-7430K
1/2" x 3/4"	335g	-7440K
1" x 3/4"	175g	-7450K



Universal Ball Joint

Male Drive x Female Drive	Weight each	Order Code KEN-583
3/4" x 3/4"	640g	-7860K



Retaining Rings
Supplied with pins



To Suit Outside Dia.	Square Drive	Weight each	Order Code KEN-583
38 - 44mm	3/4"	8g	-8200K
48 - 54mm	3/4"	16g	-8210K
46 - 58mm	1"	16g	-8300K
62mm	1"	18g	-8310K
78 - 86mm	1"	31g	-8320K



1" Drive Metric, Standard Length, 6-Point
Conform to: **DIN 3129.**

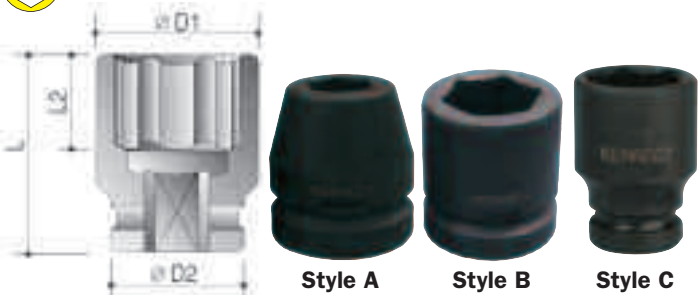

Socket (mm)	Style	Dimensions (mm)				Weight each	Order Code KEN-583
		D2	D1	L2	L		
21	A	54.0	38.0	15.0	60.0	700g	-5050K
22	A	54.0	40.0	15.0	60.0	700g	-5060K
24	A	54.0	42.0	18.0	60.0	800g	-5080K
25	A	54.0	43.0	18.0	60.0	800g	-5090K
26	A	54.0	44.5	18.0	60.0	800g	-5100K
27	A	54.0	46.0	19.0	60.0	800g	-5110K
28	A	54.0	47.0	19.0	62.0	800g	-5120K
29	A	54.0	48.0	19.0	62.0	800g	-5130K
30	A	54.0	50.0	21.0	62.0	700g	-5140K
32	A	54.0	52.0	22.0	62.0	800g	-5160K
33	A	54.0	53.0	22.0	62.0	800g	-5170K
34	B	54.0	55.0	22.0	62.0	800g	-5180K
35	B	54.0	55.0	22.0	62.0	800g	-5190K
36	B	54.0	57.0	25.0	67.0	900g	-5200K
37	B	54.0	59.0	25.0	67.0	900g	-5210K
38	B	54.0	60.0	25.0	67.0	900g	-5220K
41	B	54.0	63.0	27.0	70.0	1000g	-5250K
42	B	54.0	65.0	27.0	74.0	1200g	-5260K
46	B	54.0	70.0	30.0	76.0	1200g	-5290K
47	B	54.0	71.5	32.0	76.0	1200g	-5300K
48	B	54.0	72.5	32.0	76.0	1200g	-5310K
50	B	54.0	75.0	35.0	80.0	1500g	-5330K
52	B	54.0	77.0	35.0	84.0	1500g	-5350K
55	B	54.0	81.0	35.0	84.0	1750g	-5380K
56	B	54.0	82.0	40.0	84.0	1750g	-5390K
60	B	54.0	87.0	42.0	87.0	1750g	-5430K
65	B	54.0	93.0	42.0	90.0	2000g	-5460K
70	B	54.0	100.0	42.0	96.0	3000g	-5480K
75	B	86.0	106.0	45.0	98.0	4000g	-5500K
80	B	86.0	112.0	48.0	100.0	4000g	-5520K
85	B	86.0	118.0	52.0	105.0	5000g	-5530K
90	B	86.0	125.0	52.0	105.0	5000g	-5550K
95	B	86.0	131.0	52.0	115.0	6000g	-5570K
100	B	95.0	137.0	58.0	115.0	7000g	-5580K

7 Piece Set - Metric

Standard length: 19, 24, 27, 30, 32, 36 and 46mm.



7 PIECES



Number of Pieces	Weight each	Order Code KEN-583
7	4.20kg	-9890K



3/4" Drive Extension Bars



Length (mm)	Weight each	Order Code KEN-583
100 (4")	470g	-7570K
150 (6")	810g	-7580K
230 (9")	900g	-7600K
250 (10")	1350g	-7610K
300 (12")	1500g	-7620K
400 (15 3/4")	1900g	-7640K



1" Drive Inch Size, Standard Length, 6-Point
Conform to: **SAE, USA Federal Standard GGG-W-660A.**

Socket (inch)	Style	Dimensions (mm)				Weight each	Order Code KEN-583
		D2	D1	L2	L		
7/8"	A	51.0	39.0	15.0	58.0	550g	-5610K
15/16"	A	51.0	40.0	18.0	58.0	550g	-5620K
1"	A	51.0	42.0	18.0	58.0	550g	-5630K
1 1/16"	A	51.0	44.0	19.0	58.0	600g	-5640K
1 1/8"	A	51.0	46.0	19.0	58.0	600g	-5650K
1 3/16"	A	51.0	48.0	21.0	60.0	650g	-5660K
1 1/4"	B	51.0	51.0	22.0	60.0	650g	-5670K
1 5/16"	C	52.0	53.0	22.0	62.0	733g	-5680K
1 7/16"	C	52.0	56.0	25.0	62.0	700g	-5700K
1 1/2"	C	52.0	58.0	25.0	62.0	800g	-5710K
1 9/16"	C	52.0	60.0	25.0	62.0	800g	-5720K
1 5/8"	C	52.0	61.5	27.0	62.0	800g	-5730K
1 11/16"	C	52.0	65.0	27.0	64.0	900g	-5740K
1 3/4"	C	58.0	66.0	27.0	64.0	1000g	-5750K
1 13/16"	C	58.0	68.0	30.0	64.0	1100g	-5760K
1 7/8"	C	58.0	70.0	32.0	66.0	1100g	-5770K
2"	C	58.0	74.0	35.0	70.0	1250g	-5790K
2 1/16"	C	58.0	75.0	35.0	70.0	1250g	-5800K
2 1/8"	C	58.0	78.0	35.0	70.0	1250g	-5810K
2 3/16"	C	62.0	80.0	35.0	72.0	1500g	-5820K
2 1/4"	C	62.0	84.0	40.0	75.0	1500g	-5830K
2 3/8"	C	62.0	87.0	42.0	78.0	1500g	-5850K
2 1/2"	C	62.0	91.0	42.0	80.0	2500g	-5870K
2 9/16"	C	62.0	93.0	42.0	80.0	2500g	-5880K
2 5/8"	C	62.0	95.0	42.0	82.0	2500g	-5890K
2 3/4"	C	62.0	100.0	42.0	96.0	3000g	-5910K
2 13/16"	C	62.0	102.0	45.0	96.0	4000g	-5920K
3"	C	86.0	107.0	48.0	100.0	4000g	-5950K
3 1/8"	C	86.0	111.0	48.0	100.0	5000g	-5970K
3 1/2"	C	86.0	124.0	52.0	105.0	5000g	-6000K



1" Drive BSW Size, Standard Length, 6-Point
Conform to: **SAE, USA Federal Standard GGG-W-660A.**

Socket (BSW)	Style	Dimensions (mm)				Weight each	Order Code KEN-583
		D2	D1	L2	L		
1 1/16"	A	54.0	51.0	21.0	62	800g	-6080K
3/4"	B	54.0	53.0	22.0	62	800g	-6090K
13/16"	B	54.0	56.0	22.0	65	800g	-6100K
1"	B	54.0	66.0	27.0	74	1200g	-6130K
1 1/8"	B	56.0	70.0	32.0	66	1100g	-6140K
1 1/4"	B	54.0	77.0	36.0	84	1500g	-6150K
1 1/2"	B	62.0	89.0	42.0	78	1500g	-6170K

IMPACT SOCKETS - 1" & 1 1/2" SQUARE DRIVE

KENNEDY Chrome Molybdenum Impact Sockets & Accessories



Manufactured from high quality chrome molybdenum steel. Black oxidised finish with permanent laser etched markings.

1" Drive Metric, Deep Length, 6-Point

Conform to: **DIN 3129.**



Socket (mm)	Style	Dimensions (mm)				Weight each	Order Code KEN-583
		D2	D1	L2	L		
23	A	54.0	41.0	23.0	100.0	1200g	-6250K
24	A	54.0	42.0	24.0	100.0	1200g	-6260K
27	A	54.0	46.0	27.0	100.0	1200g	-6290K
28	A	54.0	47.0	28.0	100.0	1200g	-6300K
30	A	54.0	50.0	30.0	100.0	1200g	-6320K
32	A	54.0	52.0	32.0	100.0	1400g	-6340K
33	A	54.0	53.0	33.0	100.0	1400g	-6350K
34	B	54.0	55.0	34.0	100.0	1400g	-6360K
36	B	54.0	57.0	35.0	100.0	1400g	-6380K
37	B	54.0	59.0	37.0	100.0	1400g	-6390K
38	B	54.0	60.0	38.0	100.0	1400g	-6400K
41	B	54.0	63.0	38.0	100.0	1400g	-6430K
42	B	54.0	65.0	38.0	100.0	1400g	-6440K
46	B	54.0	70.0	38.0	100.0	1600g	-6480K
50	B	54.0	75.0	38.0	100.0	2000g	-6520K
52	B	54.0	77.0	40.0	100.0	1750g	-6540K
55	B	54.0	81.0	40.0	100.0	2000g	-6570K
56	B	54.0	82.0	40.0	105.0	2000g	-6580K
60	B	54.0	87.0	42.0	120.0	2500g	-6630K
65	B	54.0	93.0	42.0	125.0	3500g	-6660K
70	B	54.0	100.0	42.0	125.0	5000g	-6680K
75	B	86.0	106.0	45.0	135.0	6000g	-6700K
80	B	86.0	112.0	48.0	135.0	6000g	-6720K

Universal Ball Joint



Male Drive x Female Drive	Weight each	Order Code KEN-583
1" x 1"	640g	-7880K

1" Drive Reducers & Adaptors



Male Drive x Female Drive	Weight each	Order Code KEN-583
3/4" x 1"	335g	-7460K
1 1/2" x 1"	670g	-7480K

1" Drive Extension Bars



Length (mm)	Weight each	Order Code KEN-583
100 (4")	590g	-7650K
150 (6")	610g	-7660K
200 (8")	1000g	-7680K
250 (10")	2100g	-7690K
300 (12")	2500g	-7700K
380 (15")	2600g	-7720K

1" Drive Inch Size, Deep Length, 6-Point

Conform to: **SAE, USA Federal Standard GGG-W-660A.**

Socket (inch)	Style	Dimensions (mm)				Weight each	Order Code KEN-583
		D2	D1	L2	L		
1"	A	51.0	42.0	25.0	90.0	900g	-6760K
1 1/16"	A	51.0	44.0	27.0	90.0	1000g	-6770K
1 1/8"	A	51.0	46.0	29.0	90.0	1000g	-6780K
1 3/16"	A	51.0	48.0	30.0	90.0	1000g	-6790K
1 1/4"	B	51.0	51.0	32.0	90.0	1000g	-6800K
1 5/16"	C	52.0	53.0	34.0	90.0	1200g	-6810K
1 3/8"	C	52.0	54.0	35.0	90.0	1200g	-6820K
1 1/2"	C	52.0	58.0	38.0	92.0	1200g	-6840K
1 9/16"	C	52.0	60.0	38.0	92.0	1200g	-6850K
1 5/8"	C	52.0	61.5	38.0	92.0	1200g	-6860K
1 11/16"	C	52.0	65.0	38.0	92.0	1200g	-6870K
1 3/4"	C	58.0	66.0	38.0	92.0	1400g	-6880K
1 13/16"	C	58.0	68.0	38.0	92.0	1400g	-6890K
1 7/8"	C	58.0	70.0	38.0	92.0	1600g	-6900K
1 15/16"	B	58.0	72.0	38.0	100.0	1500g	-6910K
2"	C	58.0	74.0	40.0	95.0	1750g	-6920K
2 1/16"	C	58.0	75.0	40.0	95.0	1750g	-6930K
2 1/8"	C	58.0	78.0	40.0	100.0	2000g	-6940K
2 3/16"	C	62.0	80.0	40.0	100.0	2250g	-6950K
2 1/4"	C	62.0	84.0	40.0	100.0	2500g	-6960K
2 5/16"	C	62.0	86.0	40.0	105.0	2500g	-6970K
2 3/8"	C	62.0	87.0	42.0	105.0	3000g	-6980K
2 7/16"	C	62.0	89.0	42.0	110.0	3000g	-6990K
2 1/2"	C	62.0	91.0	42.0	110.0	4000g	-7000K
2 5/8"	C	62.0	95.0	42.0	125.0	4000g	-7020K
2 3/4"	C	62.0	100.0	42.0	125.0	4000g	-7040K
2 7/8"	C	86.0	104.0	42.0	125.0	5000g	-7060K
2 15/16"	C	86.0	105.0	45.0	135.0	6000g	-7070K
3"	C	86.0	107.0	48.0	135.0	6000g	-7080K
3 1/8"	B	86.0	111.0	48.0	135.0	6000g	-7100K

1" Drive BSW Size, Deep Length, 6-Point

Conform to: **SAE, USA Federal Standard GGG-W-660A.**

Socket (BSW)	Style	Dimensions (mm)				Weight each	Order Code KEN-583
		D2	D1	L2	L		
3/4"	A	54.0	53.0	33.0	100	1400g	-7150K
1 3/8"	B	54.0	82.0	40.0	105	2000g	-7220K
1 1/2"	B	62.0	89.0	42.0	110	3000g	-7230K
1 3/4"	B	60.0	102.0	45.0	125	4000g	-7250K

7 Piece Impact Socket Set

Socket sizes: 27, 30, 32, 33, 36, 41 and 46mm.



7 PIECES

Number of Pieces	Weight each	Order Code KEN-583
7	5.95kg	-9920K

1 1/2" Drive Metric Size, Standard Length, 6-Point

Conform to: **SAE, USA Federal Standard GGG-W-660A.**

Socket (mm)	Style	Dimensions (mm)				Order Code KEN-583
		D2	D1	L2	L	
30		54.0	56.0	21.0	78.0	-8430K
32		86.0	58.0	22.0	78.0	-8432K
33		86.0	60.0	22.0	78.0	-8433K
36		86.0	64.0	24.0	78.0	-8436K
38		86.0	66.0	26.0	80.0	-8438K
41		86.0	70.0	28.0	80.0	-8441K
46		86.0	76.0	30.0	84.0	-8446K
48		86.0	79.0	32.0	87.0	-8448K
50		86.0	81.0	32.0	87.0	-8450K
52		86.0	83.0	34.0	87.0	-8452K
55		86.0	87.0	37.0	90.0	-8455K
56		86.0	88.0	37.0	92.0	-8456K
60		86.0	94.0	39.0	95.0	-8460K
65		86.0	100.0	42.0	100.0	-8465K
70		86.0	106.0	46.0	105.0	-8470K
75		86.0	112.0	49.0	108.0	-8475K
80		86.0	119.0	53.0	115.0	-8480K
85		86.0	125.0	56.0	118.0	-8485K
95		95.0	137.0	61.0	123.0	-8495K

HAND TOOLS